



Chipsmall Limited consists of a professional team with an average of over 10 year of expertise in the distribution of electronic components. Based in Hongkong, we have already established firm and mutual-benefit business relationships with customers from,Europe,America and south Asia,supplying obsolete and hard-to-find components to meet their specific needs.

With the principle of “Quality Parts,Customers Priority,Honest Operation,and Considerate Service”,our business mainly focus on the distribution of electronic components. Line cards we deal with include Microchip,ALPS,ROHM,Xilinx,Pulse,ON,Everlight and Freescale. Main products comprise IC,Modules,Potentiometer,IC Socket,Relay,Connector.Our parts cover such applications as commercial,industrial, and automotives areas.

We are looking forward to setting up business relationship with you and hope to provide you with the best service and solution. Let us make a better world for our industry!



## Contact us

Tel: +86-755-8981 8866 Fax: +86-755-8427 6832

Email & Skype: info@chipsmall.com Web: www.chipsmall.com

Address: A1208, Overseas Decoration Building, #122 Zhenhua RD., Futian, Shenzhen, China



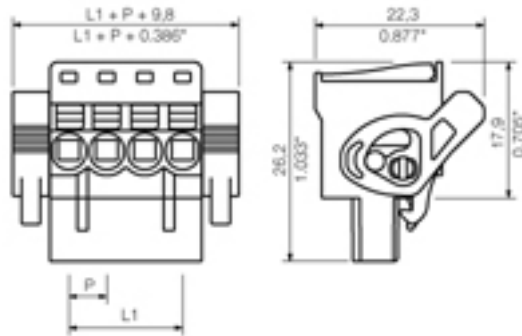

#### General ordering data

Order No.	1000410001
Part designation	BLF 5.08/02/90LR SN BK BX
Version	PCB plug-in connector, PUSH IN, Clamping range, max.: 3.31 mm <sup>2</sup> , Pitch in mm: 5.08 mm, No. of poles: 2, 90°, Box
EAN	4032248690374
Qty.	90 pc(s).
Packaging	Box

#### System parameters

Conductor connection system	PUSH IN
Outgoing direction of conductor	90°
Pitch in mm	5.08 mm
Pitch in inch	0.2 inch
No. of poles	2
No. of rows	1
Screwdriver blade	0.6 x 3.5
Screwdriver blade standard	DIN 5264
Stripping length	10 mm
L1 in mm	5.08 mm
L1 in inch	0.2 inch
Electric shock protection to DIN VDE 0470	IP 20
Electric shock protection to DIN VDE 57 106	Safe from finger touch

#### Material data

Insulating material	PBT
Colour	black
colour chart	Similar to RAL 9011
Flammability class UL 94	V-0
Contact material	CuSn
Contact surface	tinned
Contact base material	CuSn

#### Connectable conductors

Clamping range, min.	0.13 mm <sup>2</sup>
Clamping range, max.	3.31 mm <sup>2</sup>
Conductor connection cross-section AWG, min.	AWG 26
Conductor connection cross-section AWG, max.	AWG 12
Solid, min. H05(07) V-U	0.2 mm <sup>2</sup>
Solid, max. H05(07) V-U	2.5 mm <sup>2</sup>
Stranded, max. H07V-R	2 mm <sup>2</sup>
Stranded, min. H07V-R	0 mm <sup>2</sup>
Flexible, min. H05(07) V-K	0.2 mm <sup>2</sup>
Flexible, max. H05(07) V-K	2.5 mm <sup>2</sup>
w. wire end ferrule, DIN 46228 pt 1, min	0.2 mm <sup>2</sup>
with wire end ferrule, DIN 46228 pt 1, max.	2.5 mm <sup>2</sup>
w. plastic collar ferrule, DIN 46228 pt 4, min.	0.2 mm <sup>2</sup>
with plastic collar ferrule, DIN 46228 pt 4, max.	2.5 mm <sup>2</sup>
Gauge to EN 60999 a x b; ø	2.4 mm x 1.5 mm

#### DIN IEC rating data

Rated current, min. No. of poles (Tu=20°C)	18.5 A
Rated current, max. No. of poles (Tu=20°C)	6 A
Rated current, no. of poles (Tu=40°C), min.	12.5 A
Rated current, no. of poles (Tu=40°C), max.	6 A
Rated voltage for overvoltage class/pollution severity II/2	400 V
Rated voltage for overvoltage class/pollution severity III/2	320 V
Rated voltage at overvoltage category/pollution degree III/3	250 V
Rated impulse withstand voltage for overvoltage class/pollution severity II/2	4 kV
Rated impulse withstand voltage for overvoltage class/pollution severity III/2	4 kV
Rated impulse withstand voltage for overvoltage class/pollution severity III/3	4 kV
Short-time withstand current resistance	3 x 1s with 120 A

#### Approvals

Approvals institutes	CSA; CURUS; ROHS
----------------------	------------------

#### Classifications

eClass 6.0	27-26-07-08
------------	-------------

#### Notes

Notes

#### Similar products

Order No.	Part designation	Version
1000420001	BLF 5.08/03/90LR SN BK BX	PCB plug-in connector, PUSH IN, Clamping range, max.: 3.31 mm <sup>2</sup> , Pitch in mm: 5.08 mm, No. of poles: 3, 90°, Box

1000430001	BLF 5.08/04/90LR SN BK BX	PCB plug-in connector, PUSH IN, Clamping range, max.: 3.31 mm <sup>2</sup> , Pitch in mm: 5.08 mm, No. of poles: 4, 90°, Box
1000440001	BLF 5.08/05/90LR SN BK BX	PCB plug-in connector, PUSH IN, Clamping range, max.: 3.31 mm <sup>2</sup> , Pitch in mm: 5.08 mm, No. of poles: 5, 90°, Box
1000450001	BLF 5.08/06/90LR SN BK BX	PCB plug-in connector, PUSH IN, Clamping range, max.: 3.31 mm <sup>2</sup> , Pitch in mm: 5.08 mm, No. of poles: 6, 90°, Box
1000460001	BLF 5.08/07/90LR SN BK BX	PCB plug-in connector, PUSH IN, Clamping range, max.: 3.31 mm <sup>2</sup> , Pitch in mm: 5.08 mm, No. of poles: 7, 90°, Box
1000470001	BLF 5.08/08/90LR SN BK BX	PCB plug-in connector, PUSH IN, Clamping range, max.: 3.31 mm <sup>2</sup> , Pitch in mm: 5.08 mm, No. of poles: 8, 90°, Box
1000480001	BLF 5.08/09/90LR SN BK BX	PCB plug-in connector, PUSH IN, Clamping range, max.: 3.31 mm <sup>2</sup> , Pitch in mm: 5.08 mm, No. of poles: 9, 90°, Box
1000490001	BLF 5.08/10/90LR SN BK BX	PCB plug-in connector, PUSH IN, Clamping range, max.: 3.31 mm <sup>2</sup> , Pitch in mm: 5.08 mm, No. of poles: 10, 90°, Box
1000500001	BLF 5.08/11/90LR SN BK BX	PCB plug-in connector, PUSH IN, Clamping range, max.: 3.31 mm <sup>2</sup> , Pitch in mm: 5.08 mm, No. of poles: 11, 90°, Box
1000510001	BLF 5.08/12/90LR SN BK BX	PCB plug-in connector, PUSH IN, Clamping range, max.: 3.31 mm <sup>2</sup> , Pitch in mm: 5.08 mm, No. of poles: 12, 90°, Box
1000520001	BLF 5.08/13/90LR SN BK BX	PCB plug-in connector, PUSH IN, Clamping range, max.: 3.31 mm <sup>2</sup> , Pitch in mm: 5.08 mm, No. of poles: 13, 90°, Box
1000530001	BLF 5.08/14/90LR SN BK BX	PCB plug-in connector, PUSH IN, Clamping range, max.: 3.31 mm <sup>2</sup> , Pitch in mm: 5.08 mm, No. of poles: 14, 90°, Box
1000540001	BLF 5.08/15/90LR SN BK BX	PCB plug-in connector, PUSH IN, Clamping range, max.: 3.31 mm <sup>2</sup> , Pitch in mm: 5.08 mm, No. of poles: 15, 90°, Box
1000550001	BLF 5.08/16/90LR SN BK BX	PCB plug-in connector, PUSH IN, Clamping range, max.: 3.31 mm <sup>2</sup> , Pitch in mm: 5.08 mm, No. of poles: 16, 90°, Box
1000560001	BLF 5.08/17/90LR SN BK BX	PCB plug-in connector, PUSH IN, Clamping range, max.: 3.31 mm <sup>2</sup> , Pitch in mm: 5.08 mm, No. of poles: 17, 90°, Box
1000570001	BLF 5.08/18/90LR SN BK BX	PCB plug-in connector, PUSH IN, Clamping range, max.: 3.31 mm <sup>2</sup> , Pitch in mm: 5.08 mm, No. of poles: 18, 90°, Box
1000580001	BLF 5.08/19/90LR SN BK BX	PCB plug-in connector, PUSH IN, Clamping range, max.: 3.31 mm <sup>2</sup> , Pitch in mm: 5.08 mm, No. of poles: 19, 90°, Box
1000590001	BLF 5.08/20/90LR SN BK BX	PCB plug-in connector, PUSH IN, Clamping range, max.: 3.31 mm <sup>2</sup> , Pitch in mm: 5.08 mm, No. of poles: 20, 90°, Box