



Chipsmall Limited consists of a professional team with an average of over 10 year of expertise in the distribution of electronic components. Based in Hongkong, we have already established firm and mutual-benefit business relationships with customers from,Europe,America and south Asia,supplying obsolete and hard-to-find components to meet their specific needs.

With the principle of “Quality Parts,Customers Priority,Honest Operation,and Considerate Service”,our business mainly focus on the distribution of electronic components. Line cards we deal with include Microchip,ALPS,ROHM,Xilinx,Pulse,ON,Everlight and Freescale. Main products comprise IC,Modules,Potentiometer,IC Socket,Relay,Connector.Our parts cover such applications as commercial,industrial, and automotives areas.

We are looking forward to setting up business relationship with you and hope to provide you with the best service and solution. Let us make a better world for our industry!



Contact us

Tel: +86-755-8981 8866 Fax: +86-755-8427 6832

Email & Skype: info@chipsmall.com Web: www.chipsmall.com

Address: A1208, Overseas Decoration Building, #122 Zhenhua RD., Futian, Shenzhen, China



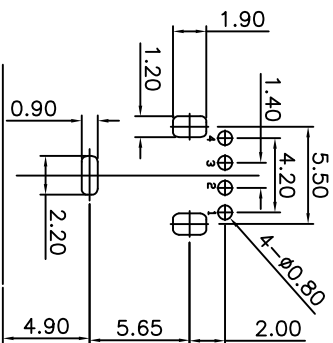
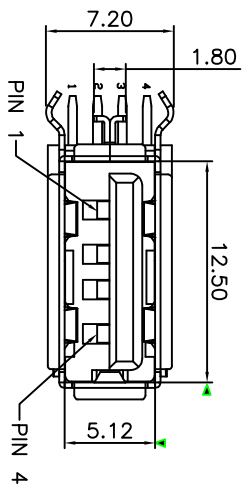

RECOMMEND PCB LAYOUT

NOTE:
 MATERIAL: PBT+30%GF (UL 94V-0)
 HOUSING: PBT+30%GF (UL 94V-0)
 INSULATOR Color: Black
 SHELL:BRASS C2680-H T=0.3mm
 TERMINAL:PHOSPHOR BRONZE C5191-H T=0.20mm
 SPECIFICATION:
 VOLTAGE CURRENT RATING:1AMP 30V DC
 INSULATION RESISTANCE:1000MΩ MIN
 CONTACT RESISTANCE TERMINAL:30mΩ MAX
 WITHSTANDING VOLTAGE:500V AC
 MATING FORCE:30N MAX
 UNMATING FORCE:10N MIN

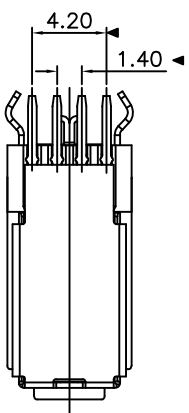
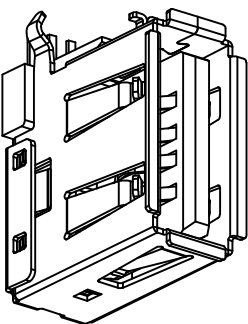
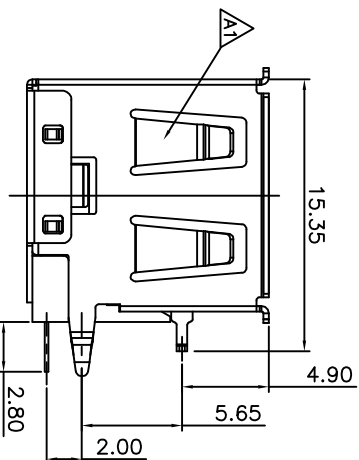
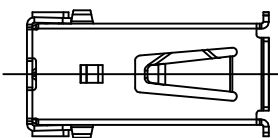
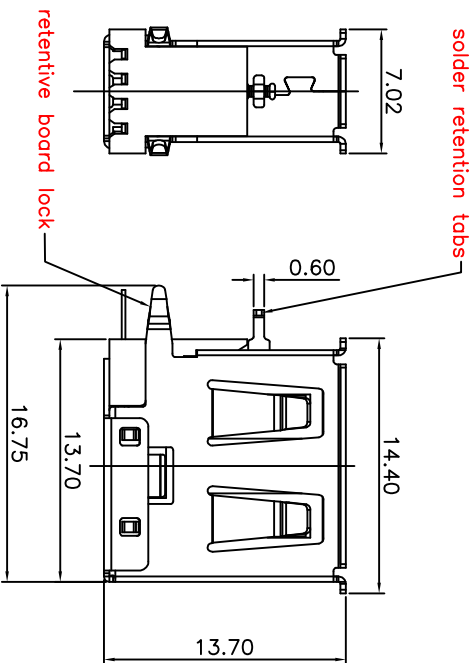

Pin Number	Signal Name
1	VBUS
2	D-
3	D+
4	GND
Shell	Shield

11/12/17	XIE	EG-N1112018	(新增壳)将原来四弹片加宽，增加接触面积		A1
11/08/05	XIE		NEW DWG		A0
DATE	DR.BY	Ecn.No.	DESCRIPTION	MARK	VER.

CnC Tech,LLC



TITLE: USB 4P AVF DIP 90度侧插式
 三只脚成品

UNLESS OTHERWISE SPECIFIED					
X.X	±0.30	X.X°	±3.00°	APPD:	PRODUCT NO: 1002-013-01001
X.XX	±0.25	X.XX°	±2.00°	CHECK:	DATE
X.XXX	±0.15	X.XXX°	±1.00°	DRAW:	SCALE
					UNIT
					TYPE
					PAGE
					1/1