



Chipsmall Limited consists of a professional team with an average of over 10 year of expertise in the distribution of electronic components. Based in Hongkong, we have already established firm and mutual-benefit business relationships with customers from,Europe,America and south Asia,supplying obsolete and hard-to-find components to meet their specific needs.

With the principle of “Quality Parts,Customers Priority,Honest Operation,and Considerate Service”,our business mainly focus on the distribution of electronic components. Line cards we deal with include Microchip,ALPS,ROHM,Xilinx,Pulse,ON,Everlight and Freescale. Main products comprise IC,Modules,Potentiometer,IC Socket,Relay,Connector.Our parts cover such applications as commercial,industrial, and automotives areas.

We are looking forward to setting up business relationship with you and hope to provide you with the best service and solution. Let us make a better world for our industry!



Contact us

Tel: +86-755-8981 8866 Fax: +86-755-8427 6832

Email & Skype: info@chipsmall.com Web: www.chipsmall.com

Address: A1208, Overseas Decoration Building, #122 Zhenhua RD., Futian, Shenzhen, China



PRODUCT NO.	INSULATOR
10030581-100LF	NO
10030581-110LF	YES
10030581-200LF	NO
10030581-210LF	YES 10030591-100
10030581-220LF	YES 10030591-110
10030581-300LF	NO
10030581-310LF	YES

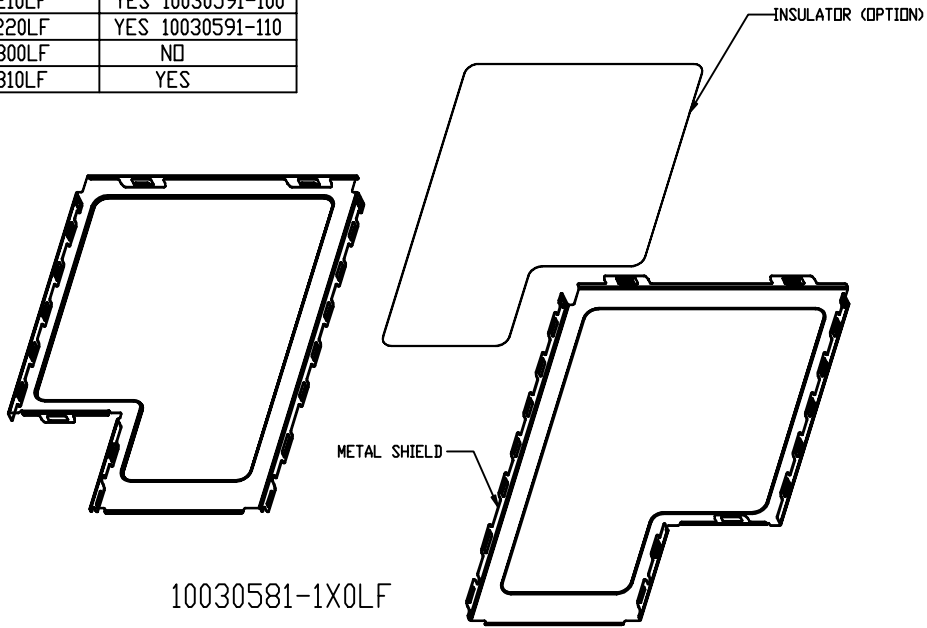

10030581-1X0LF

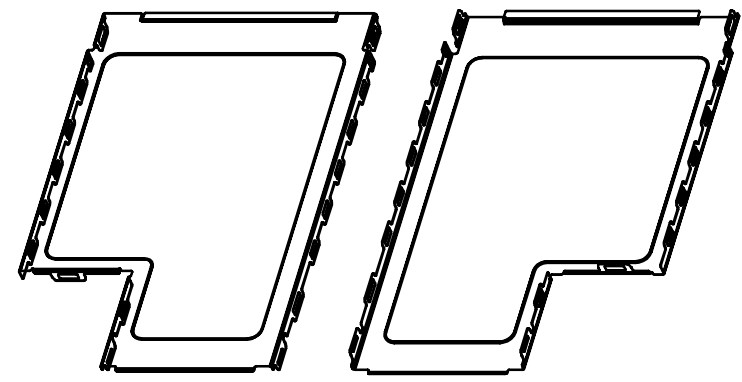

10030581-2X0LF

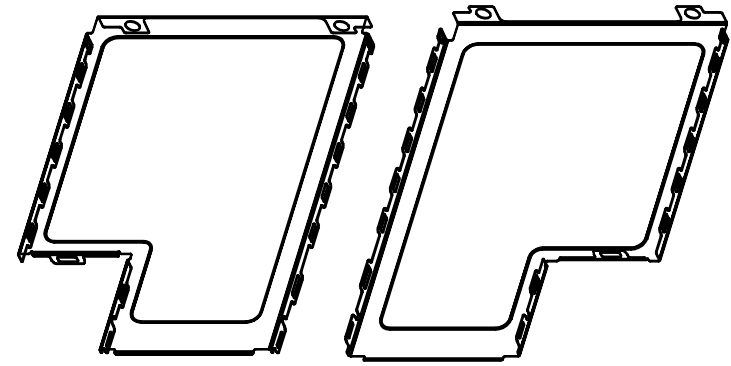

10030581-3X0LF



NOTES:
 1. MATERIAL PROPERTIES:
 METAL SHIELD : STAINLESS STEEL, SURFACE FINISH : MATTE.
 INSULATOR : POLYESTER FILM WITH ADHESIVE, 3M 1350 OR EQUIVALENT.
 2. PART NUMBER SCHEME:

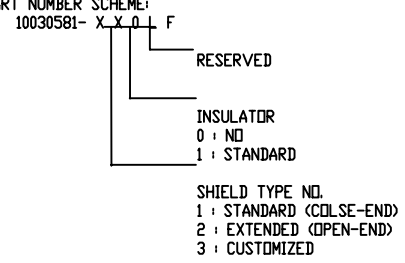

3. PRODUCT PERFORMANCE PER SPEC. GS-12-292.
 4. PACKAGING SPEC. PER GS-14-927.
 5. THIS PRODUCT IS ROHS COMPLIANT, AND MEETS EUROPEAN UNION DIRECTIVES AND OTHER COUNTRY REGULATIONS AS PER GS-22-008.

rev	ecn no	dr	date
H	N07-0182	MSH	2007-08-08
D	T05-0228	D T	2005-10-18
E	T06-0015	D T	2006-01-16
F	T06-0057	D T	2006-04-17
G	T06-0144	D T	2006-08-02

www.fciconnect.com			surface	tolerance std	projection	MM
			TOLERANCES UNLESS OTHERWISE SPECIFIED			
Dr	DAVID TENG	2004-10-04	ANGULAR	0.X	±0.30	size A4
Eng	DAVID TENG	2004-10-04	LINEAR	0.XX	±0.15	Scale 1.000
Chr	PAUL WANG	2004-10-04	0° ±2°	0.XXX	±0.08	ECN *
Appr	JOSEPH HSIA	2004-10-04	Product family		Spec ref *	
			title TOP SHIELD SUB-ASSEMBLY		chg no 10030581	Rev. H
			catalog no 10030581		CUSTOMER	sheet 1 of 5

PRODUCT NO.
10030581-1X0LF

A

B

C

D

1

2

3

4

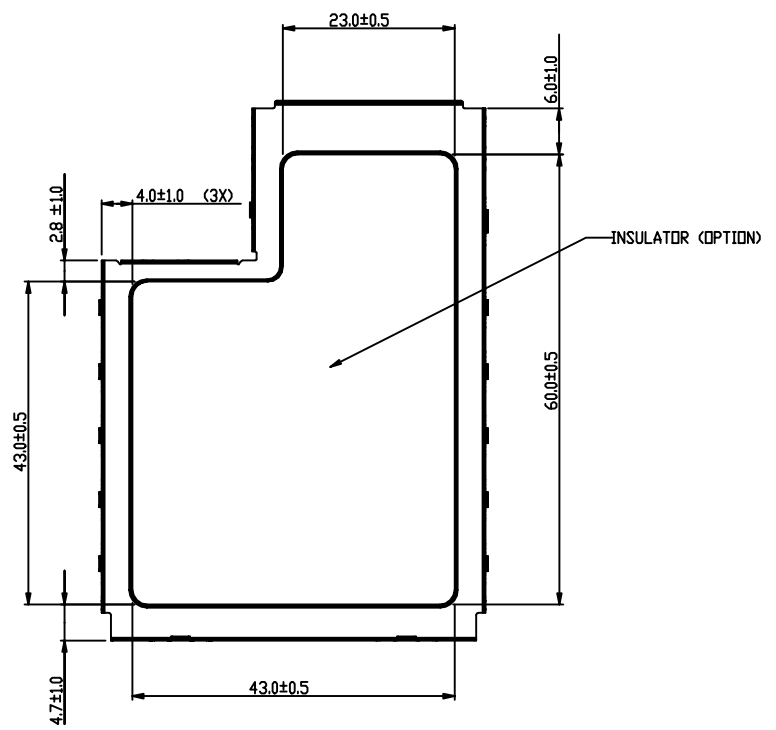
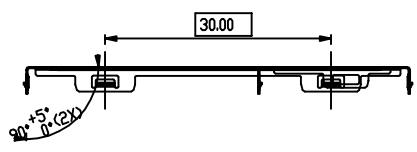
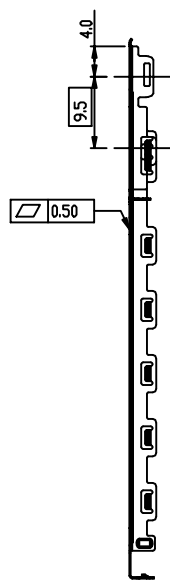
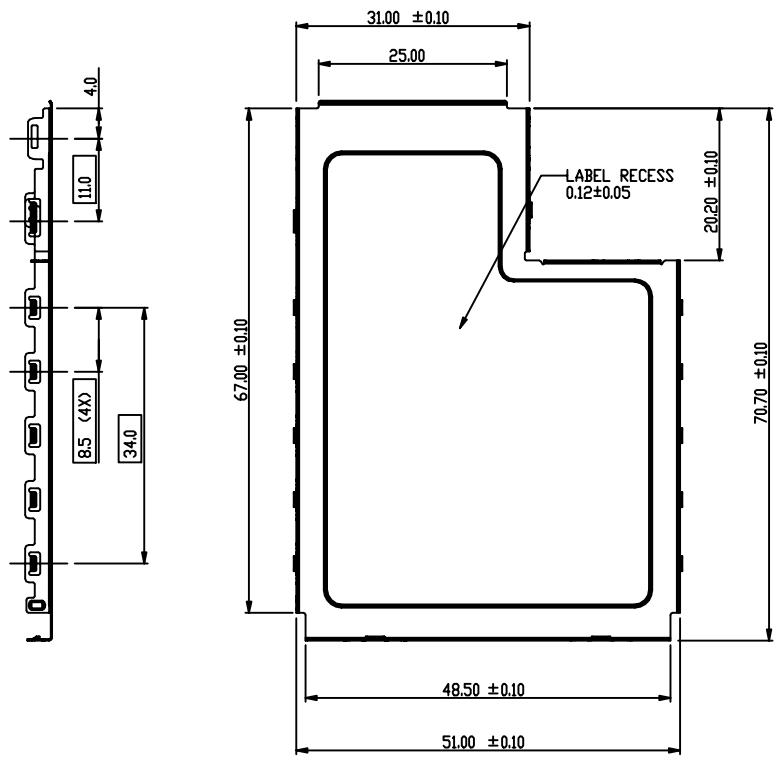

TOLERANCES UNLESS OTHERWISE SPECIFIED		
LINEAR	0.X	±0.30
	0.XX	±0.15
	0.XXX	±0.08
ANGULAR	0°	±5°

	title TOP SHIELD SUB-ASSEMBLY EXPRESSCARD/54 MODULE CARD KIT	dwg no 10030581	Rev. H
	catalog no 10030581	CUSTOMER	sheet 2 of 5



Copyright FCI.

REV F - 2006-04-17

1

2

3 PDM: Rev:H

STATUS Released

4

Printed: Oct 12, 2010

1

2

3

4

PRODUCT NO.
10030581-2X0LF

A

B

C

D

A

B

C

D



Copyright FCI.

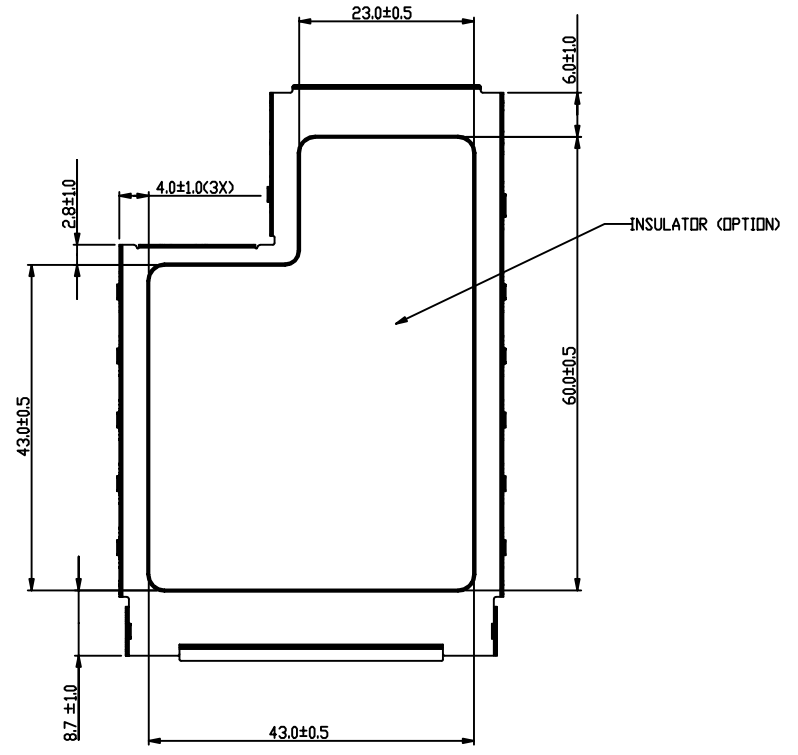
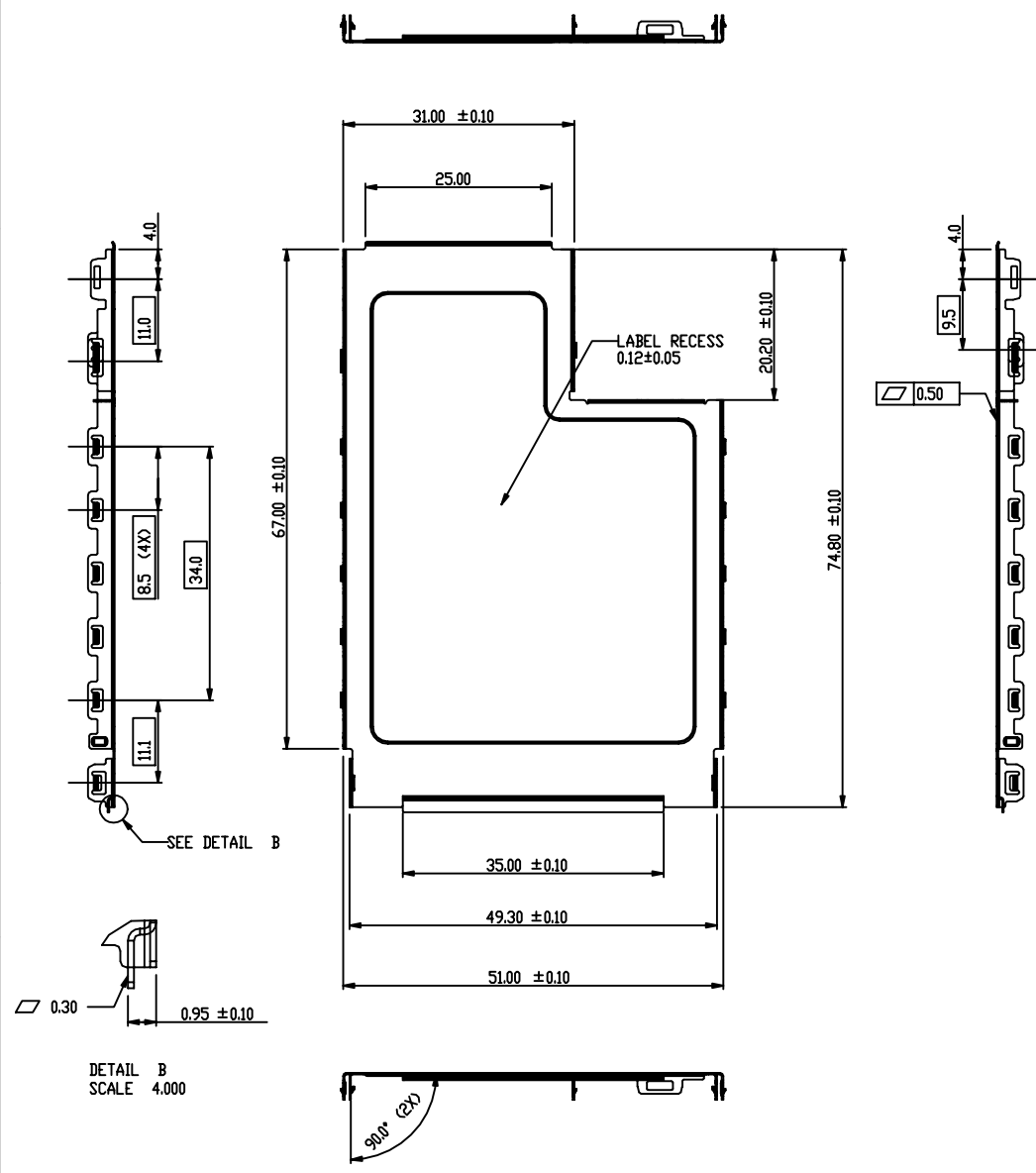

DETAIL B
SCALE 4.000

TOLERANCES UNLESS OTHERWISE SPECIFIED		
LINEAR	0.X	±0.30
	0.XX	±0.15
	0.XXX	±0.08
ANGULAR	0°	±5°

	title TOP SHIELD SUB-ASSEMBLY EXPRESSCARD/54 MODULE CARD KIT	dwg no 10030581	Rev. H
	catalog no 10030581	CUSTOMER	sheet 3 of 5

REV F - 2006-04-17

1

2

3 PDM: Rev:H

STATUS Released

4

Printed: Oct 12, 2010

1

2

3

4

PRODUCT NO.
10030581-220LF

A

B

C

D

A

B

C

D

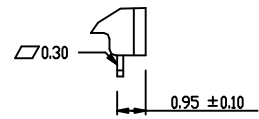
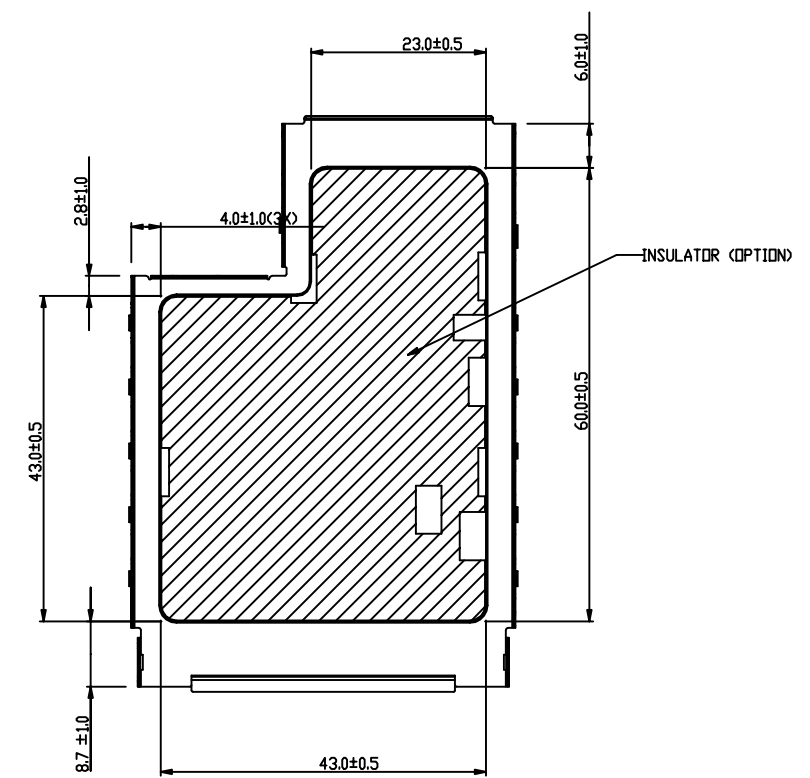
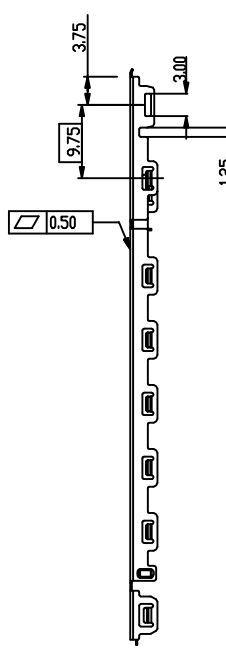
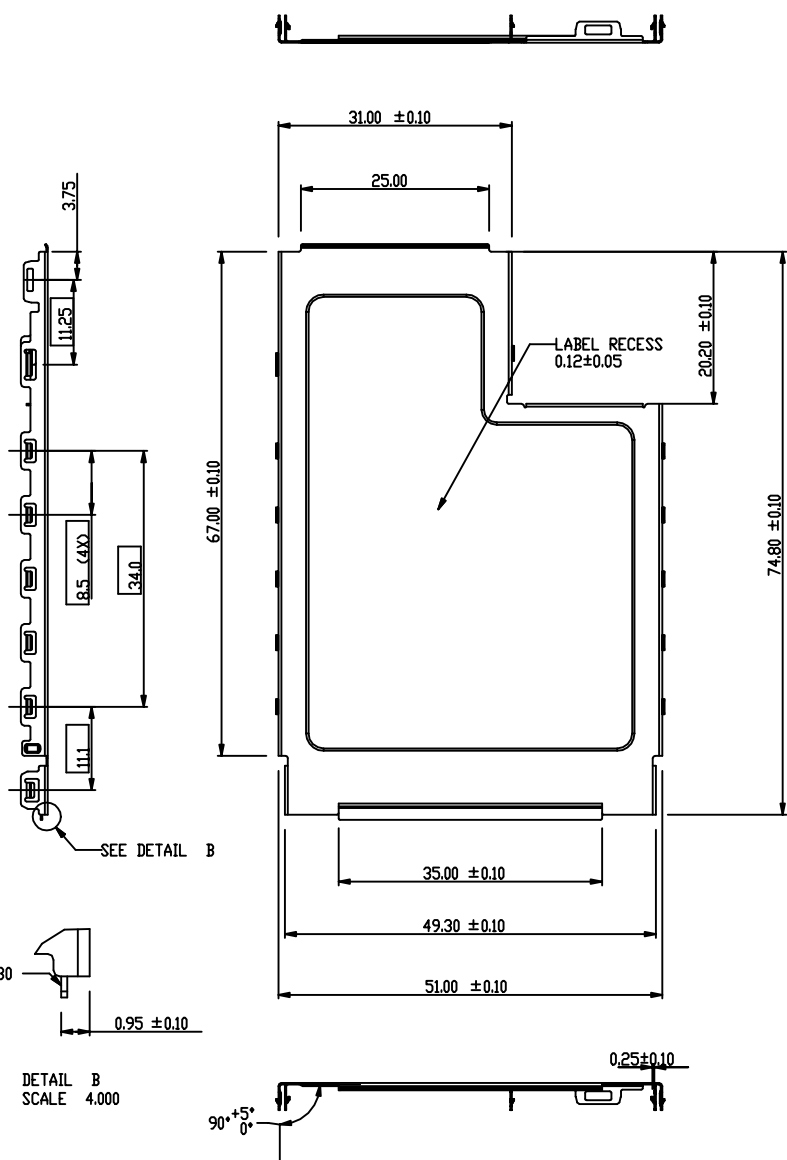

DETAIL B
SCALE 4.000

TOLERANCES UNLESS OTHERWISE SPECIFIED		
LINEAR	0.X	±0.30
	0.XX	±0.15
	0.XXX	±0.08
ANGULAR	0°	±5°



Copyright FCI.

REV F - 0806-04-17

1

2

3 PDM: Rev:H

STATUS Released

4

Printed: Oct 12, 2010

	title	TOP SHIELD SUB-ASSEMBLY EXPRESSCARD/54 MODULE CARD KIT	dwg no	10030581	Rev.	H
	catalog no	10030581	CUSTOMER	sheet 4 of 5		

PRODUCT NO.
10030581-3X0LF

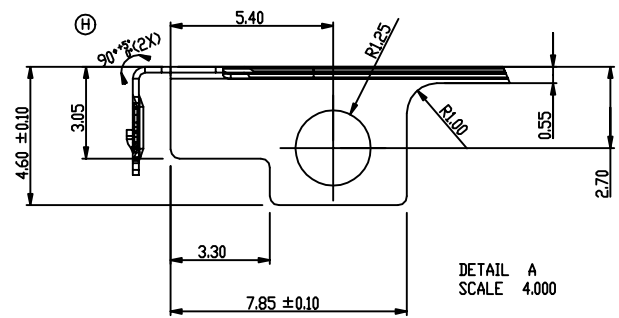
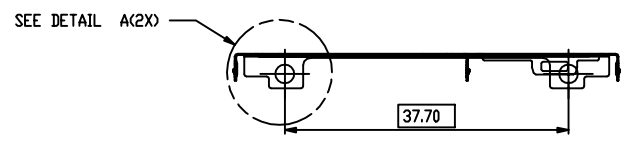
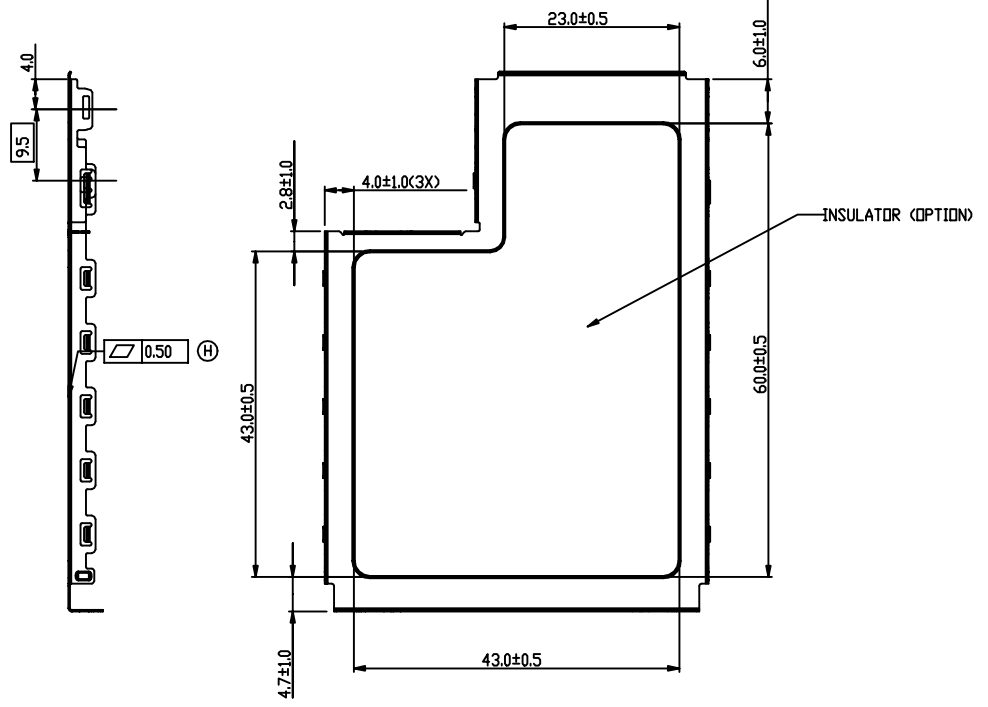
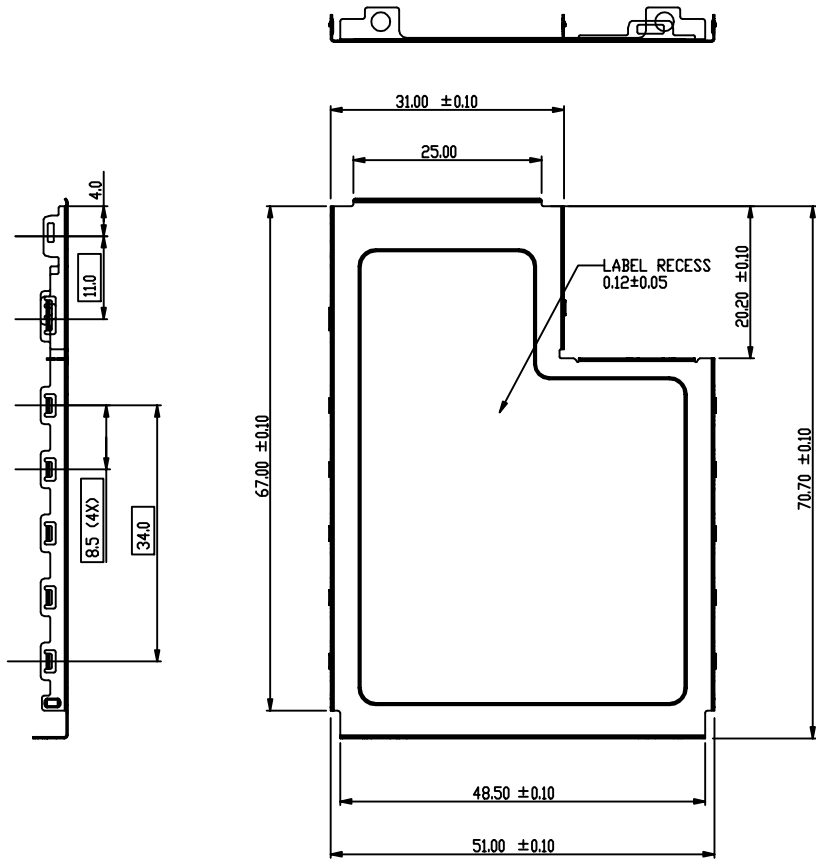

TOLERANCES UNLESS OTHERWISE SPECIFIED		
LINEAR	0.X	±0.30
	0.XX	±0.15
	0.XXX	±0.08
ANGULAR	0°	±2°



title TOP SHIELD SUB-ASSEMBLY
EXPRESSCARD/54 MODULE CARD KIT
catalog no 10030581

dwg no 10030581
CUSTOMER
sheet 5 of 5
Rev. H



Copyright FCI.