



Chipsmall Limited consists of a professional team with an average of over 10 year of expertise in the distribution of electronic components. Based in Hongkong, we have already established firm and mutual-benefit business relationships with customers from,Europe,America and south Asia,supplying obsolete and hard-to-find components to meet their specific needs.

With the principle of “Quality Parts,Customers Priority,Honest Operation,and Considerate Service”,our business mainly focus on the distribution of electronic components. Line cards we deal with include Microchip,ALPS,ROHM,Xilinx,Pulse,ON,Everlight and Freescale. Main products comprise IC,Modules,Potentiometer,IC Socket,Relay,Connector.Our parts cover such applications as commercial,industrial, and automotives areas.

We are looking forward to setting up business relationship with you and hope to provide you with the best service and solution. Let us make a better world for our industry!



## Contact us

Tel: +86-755-8981 8866 Fax: +86-755-8427 6832

Email & Skype: info@chipsmall.com Web: www.chipsmall.com

Address: A1208, Overseas Decoration Building, #122 Zhenhua RD., Futian, Shenzhen, China





# Me Auriga

SKU: 10060 Weight: 112.00 Gram



## What is Me Auriga?

Me Auriga is the updated version of Orion which is equipped with several sensors. The previous two red ports have been changed into four but remain the functions. Also, PORT5 is isolated only with serial communication function. So it can't be used to update program and is only for communication. Also, it is compatible with USB serial port. PORT6 to PORT10 are compatible with dual-digital, simulation, I2C bus, unibus, and simulated serial port. Me Auriga has an encoder motor port, smart servo port, and LED Ring Panel port (with power switch). Besides, the PCB is also enlarged.

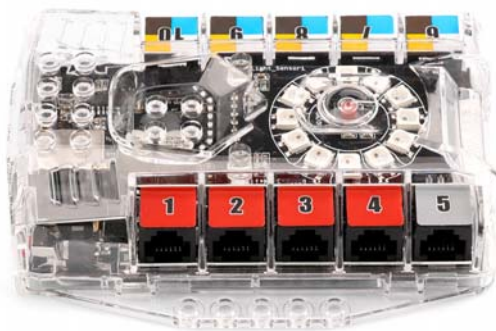



## Versatile Usage

- Easy to connect with sensors, electronic modules and motor drives;
- Support DC motors, stepper motors, servo motors, smart servos, encoder motors, etc;
- Drive two encoder motors at the same time;  
Over-current protection – 2.4A (instantaneous);
- One power switch to control the whole circuit;
- PORT5-PORT10 support continuously 5V 2.4A output (up to 3A);
- PORT1-PORT4 support continuously 3.5A output (up to 5A);
- PORT5-PORT10 support short-circuit protection and over-current protection for 3A;
- PORT1-PORT4 support short-circuit protection and over-current protection for 3.5A;
- USB port with antistatic protection;
- Peripherals:
  - Gyroscope
  - Sound sensor
  - Passive buzzer
  - Temperature sensor
  - 12 PXL LED RGB panel with light intensity sensor

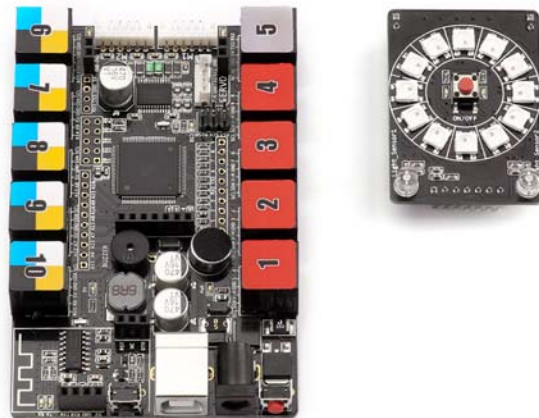
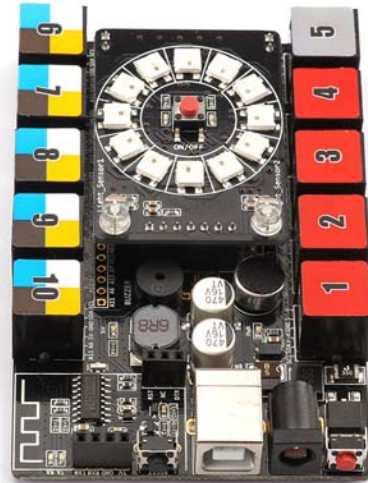

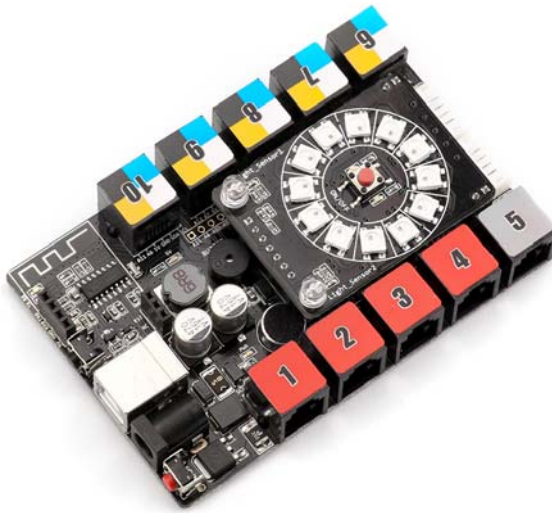

## Compatibility



- Compatible with ARDUINO IDE;
- Compatible with RJ25 port;
- Special library for Arduino; powerful and easy to understand;
- Support Bluetooth and Bluetooth upgrade firmware.

## △ Note

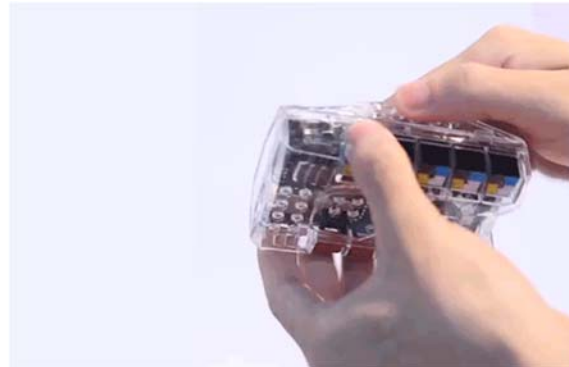
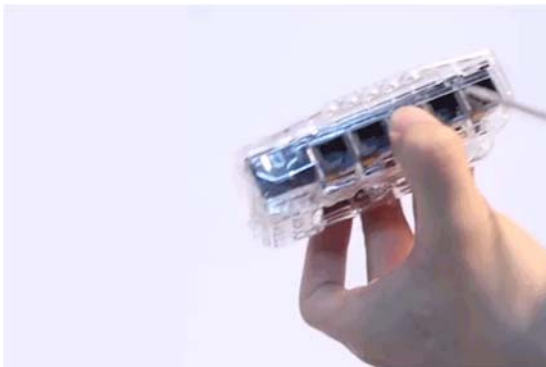
The plastic case is a little difficult to open, so please slightly pry off its corners first, then open it. See the GIF.



## Introduction to Interfaces of Me Auriga

Port NO.	Tag Color	Compatible Module Types	Typical Me Modules
1 & 2 & 3 & 4		(6-12V DC) Driven modules	Me Motor Driver Me Servo Driver Me Stepper Driver
5		Hardware serial port	Me Bluetooth Me Bluetooth Module (Dual-Mode)
6 & 7 & 8 & 9 & 10		One way digital interface Dual digital interface I <sup>2</sup> C port Dual & one way analog interface	Me Ultrasonic Sensor Me RGB LED Me Limit Switch Me 7 Segment Serial Display Me PIR Motion Sensor Me Shutter Me Line Finder Me Infrared Receiver Decode Me 3 Axis Accelerometer and Gyro Sensor Me Potentiometer Me Joystick Me 4Button Me Sound Sensor ...

## Me Auriga

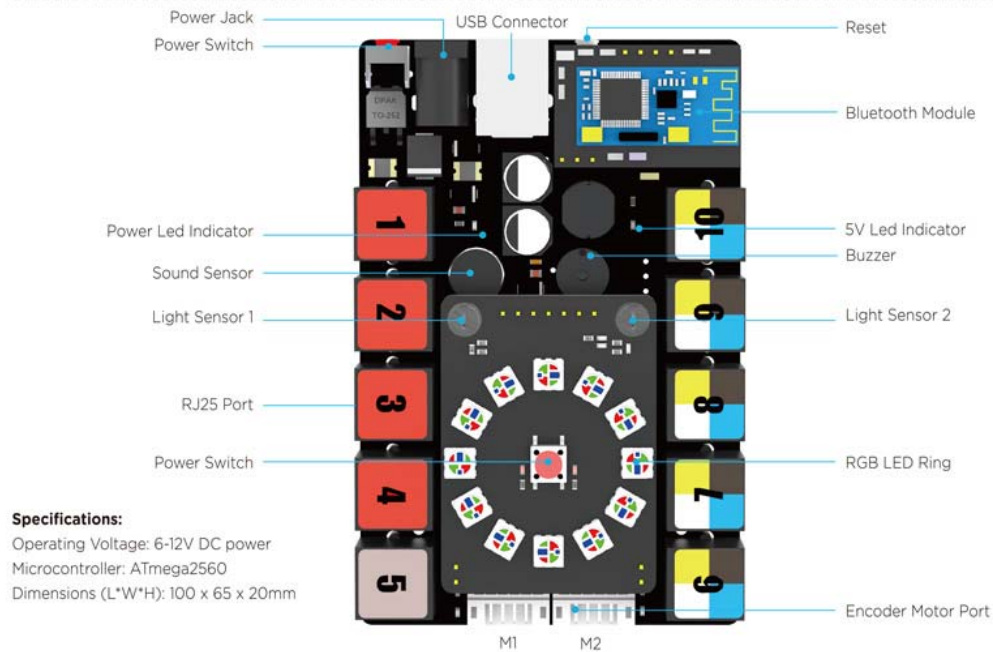

## Light Sensor

Me Auriga has two on-board light sensors. Each of Ranger's light sensors can measure how much light is shining on it. The more light shines on the sensors, the higher the signal it feeds back. Light sensors can be used to make an intelligent dimming lamp, a light-avoiding robot and a light-following robot.

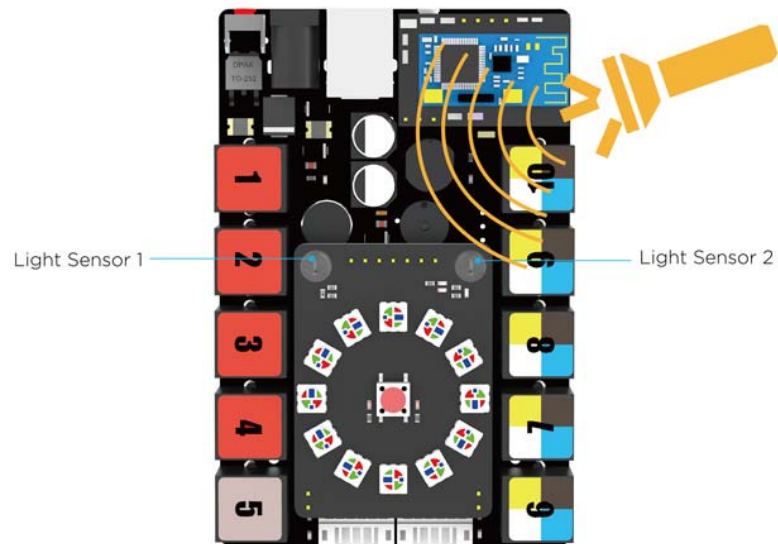

## Sound Sensor

The sound sensor on Me Auriga is designed to detect the intensity of sound in the surrounding environment. Based on the LM386 power amplifier and the electret microphone, the sound sensor can output analog values ranging from 0 to 1023. It can be used in sound interactive projects, such as a voice operated switch.

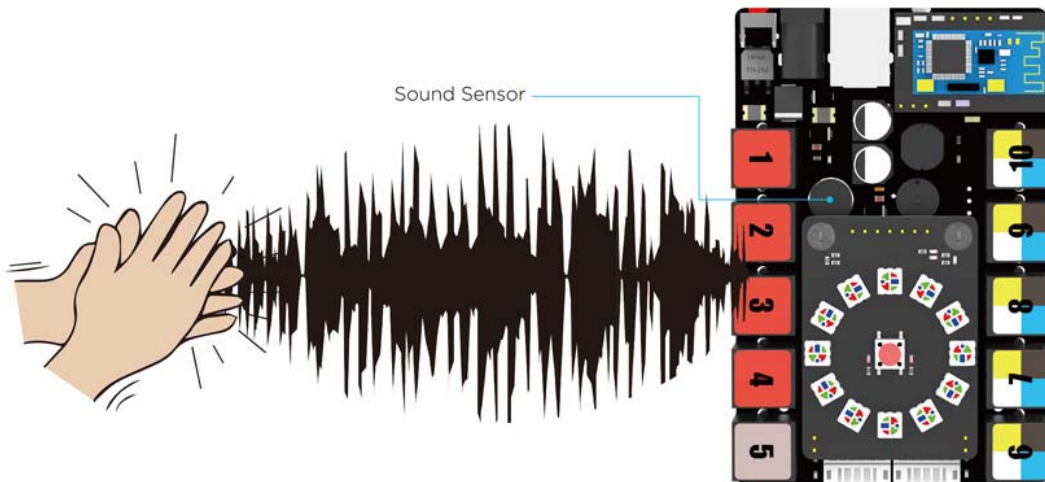

## Gyroscope Sensor

Ranger's on-board gyro sensor is a motion processing module. It measures the angular rate and the acceleration information of your robot. Based on MPU-6050, this gyro sensor combines a 3-axis gyroscope, 3-axis accelerometer, and a Digital Motion Processor™ (DMP) capable of processing complex 9-axis Motion Fusion algorithms. It can be used together with encoder motor to build a self-balance car.

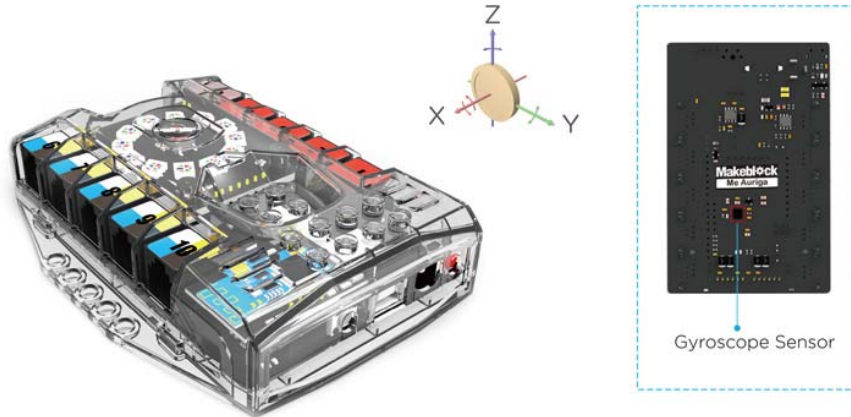

## Temperature Sensor

The Ranger's on-board temperature sensor contains a tiny thermometer (a NTC thermistor) that detects the temperature of the surroundings.

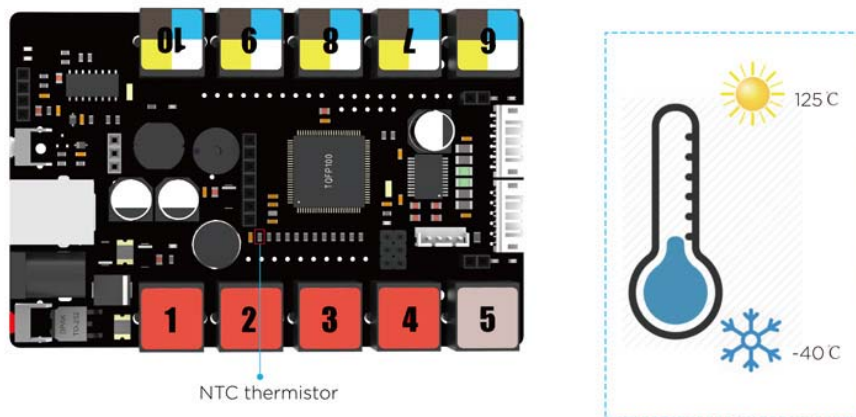

For more information, please click here. <http://learn.makeblock.com/en/me-auriga/>

---

Specifications	
Output Voltage	5V DC & 6 - 12V DC
Input Voltage	6 - 12V DC
Maximum instantaneous output current (PORT1-PORT4)	5A (continuous output: 3A)
Maximum instantaneous output current (PORT5-PORT10)	3A (continuous output: 2.4A)
Communication Mode	UART, I2C, digital input/output, analog input/output
Main Controller	Atmega 2560
Circuit Board Dimension	100 x 65x 18 mm (L x W x H)
Package Dimension	188 x 150 x 29mm (7.40 x 5.90 x 1.14inch)
Product Dimension	109 x 88 x 27mm (4.29 x 3.46 x 1.06inch)
Part List	Me Auriga V1.0 x 1(Bluetooth Module Excluded) Me Auriga Case x 1