



Chipsmall Limited consists of a professional team with an average of over 10 year of expertise in the distribution of electronic components. Based in Hongkong, we have already established firm and mutual-benefit business relationships with customers from,Europe,America and south Asia,supplying obsolete and hard-to-find components to meet their specific needs.

With the principle of “Quality Parts,Customers Priority,Honest Operation,and Considerate Service”,our business mainly focus on the distribution of electronic components. Line cards we deal with include Microchip,ALPS,ROHM,Xilinx,Pulse,ON,Everlight and Freescale. Main products comprise IC,Modules,Potentiometer,IC Socket,Relay,Connector.Our parts cover such applications as commercial,industrial, and automotives areas.

We are looking forward to setting up business relationship with you and hope to provide you with the best service and solution. Let us make a better world for our industry!



Contact us

Tel: +86-755-8981 8866 Fax: +86-755-8427 6832

Email & Skype: info@chipsmall.com Web: www.chipsmall.com

Address: A1208, Overseas Decoration Building, #122 Zhenhua RD., Futian, Shenzhen, China



PRODUCT NUMBER
10075025-XXX-XXXLF

PLATING

S = 0.38µm GOLD/GXT ON CONTACT AREA
2µm MIN MATTE TIN ON TAIL

G = 0.76µm GOLD/GXT ON CONTACT AREA
2µm MIN MATTE TIN ON TAIL

F = GOLD FLASH ON CONTACT AREA
2µm MIN MATTE TIN ON TAIL

1.27µm MIN NICKEL UNDERPLATING

PIN STYLE	TAIL LENGTH	MISSING PIN POSITION
01	2.00	
02	2.50	
03	2.00	A01

LEAD FREE
RoHS COMPATIBLE
NOTE 7

PACKAGING
NOTE 5

TOTAL NUMBER OF
POSITIONS 04 TO 50

NOTES:

- MATERIAL HOUSING: HIGH TEMP. THERMOPLASTIC UL 94V-0, COLOR NATURAL
- MATERIAL TERMINAL: COPPER ALLOY
- TO DETERMINE DIMENSIONS:
N = NUMBER OF POSITIONS PER ROW
- 7N MIN. PIN RETENTION IN EITHER DIRECTION.
- PACKAGING:
= STANDARD PACKAGING IN POLYBAG
U = TUBE AVAILABLE FROM 03 TO 25 POS PER ROW
A = TAPE & REEL WITH PICK UP CAP, AS AVAILABLE.

- POLARIZATION :
- SEE TABLE FOR AVAILABILITY
- FOR NEW REQUEST, PLEASE TO CONTACT FCI

7. RoHS COMPATIBLE PRODUCT SPECIFICATIONS

a - PLATING:

- "LF" MEANS THE PRODUCT IS LEAD-FREE, 2µm MINIMUM MATTE TIN OVER 1.27µm MINIMUM NICKEL UNDERPLATE.

b - MANUFACTURING PROCESS COMPATIBILITY

- THE HOUSING WILL WITHSTAND EXPOSURE TO 260°C PEAK TEMPERATURE FOR 30 SECONDS MAX IN A CONVECTION, INFRA-RED, OR VAPOR PHASE OR REFLOW OVEN

c - LABELLING:

- MEETS PACKAGING SPECS AS PER GS-14-920

d - LEGAL STATEMENT : SEE GS-47-0004

INDICATES POS 1

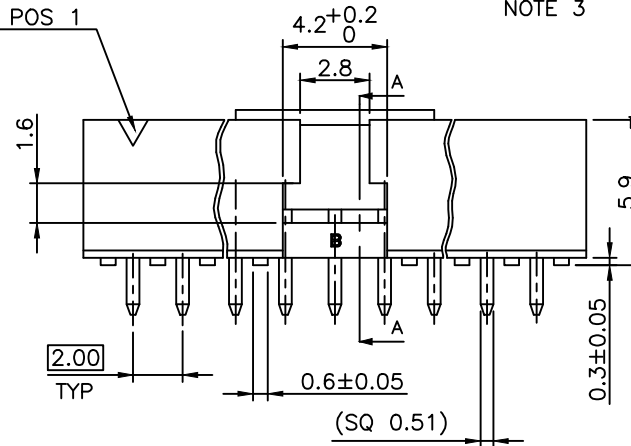

OPTIONAL PICK UP CAP

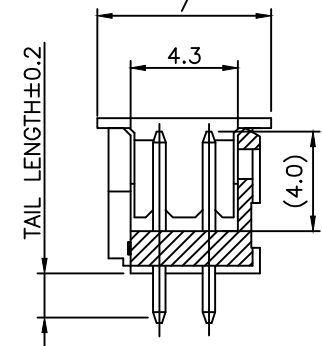

SECTION A-A

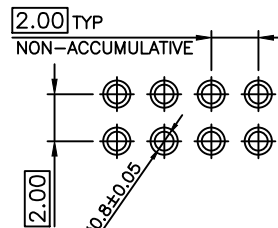

RECOMMENDED 1.6mm THICK PCB LAYOUT
STENCIL DESIGN RECOMMENDATIONS
AS PER TA-896

mat'l. code		surface		tolerance		projection		product family	
		ISO 1302 ✓		ISO 406 ISO 1101		mm		MINITEK	
ltr		ecn no		date		tolerances unless otherwise specified		title	
R		F-23051		AMA		16.01.15		UNSHR.HEADER	
S		F-24837		AMA		16.08.29		2.00 mm VERTICAL PIP	
T		F-24838		LMU		16.08.29		dwg no	
								sheet 1 of 2	
M		B-20079		AMA		15.01.23		size	
N		B-20254		LMU		15.02.16		10075025	
P		B-21209		AMA		15.06.22		A3	
sheet		revision		T		B		type	
index		sheet		1		2		CUSTOMER Drawing	



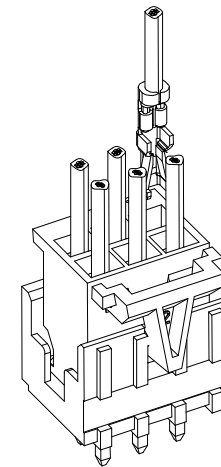
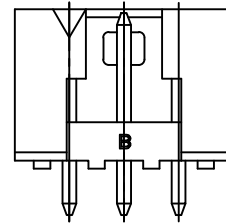
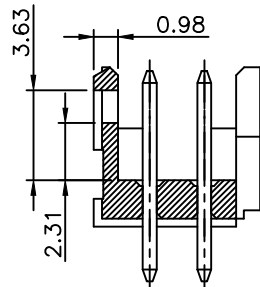
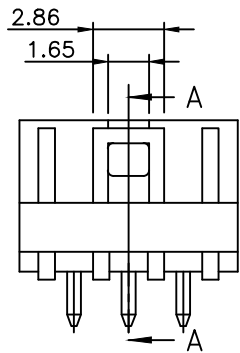

2x3 POS AND 2x4 POS CONFIGURATION
NO LATCHING AVAILABLE FOR 2x2 POS

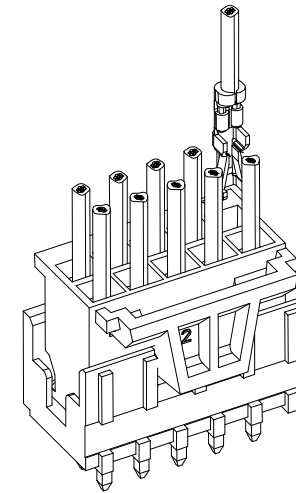
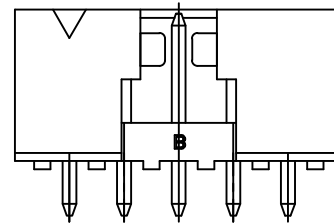
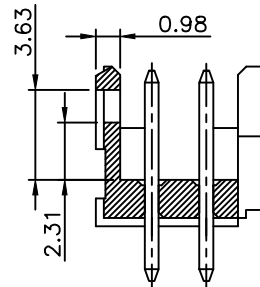
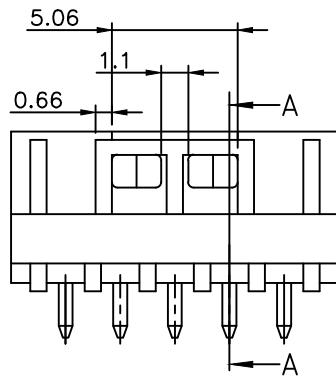

2x5 POS UP TO 2x25 POS CONFIGURATION

LATCHING FEATURES WHEN USED IN COMBINATION
WITH ACTIVE LATCH HOUSING 10073599

mat'l. code		surface		tolerance		projection		product family	
		ISO 1302		ISO 406 ISO 1101		mm		MINITEK	
ltr		ecn no		dr		date		title	
A		F06-0113		LMU		08.01.07		UNSHR.HEADER	
B		B-17556		JCO		14.04.23		2.00 mm VERTICAL PIP	
				angles		linear		scale 5:1	
						.x ±0.3		dwg no	
						.xx ±0.15		sheet 2 of 2	
						.xxx ±0.05		size	
				dr		L MULIN		07.12.04	
				enr		J.COMPAGNON		07.12.04	
				chr					
				appd		JM.C		07.12.04	
sheet		revision						type	
index		sheet						CUSTOMER Drawing	



Copyright FCI