



Chipsmall Limited consists of a professional team with an average of over 10 year of expertise in the distribution of electronic components. Based in Hongkong, we have already established firm and mutual-benefit business relationships with customers from,Europe,America and south Asia,supplying obsolete and hard-to-find components to meet their specific needs.

With the principle of "Quality Parts,Customers Priority,Honest Operation,and Considerate Service",our business mainly focus on the distribution of electronic components. Line cards we deal with include Microchip,ALPS,ROHM,Xilinx,Pulse,ON,Everlight and Freescale. Main products comprise IC,Modules,Potentiometer,IC Socket,Relay,Connector.Our parts cover such applications as commercial,industrial, and automotives areas.

We are looking forward to setting up business relationship with you and hope to provide you with the best service and solution. Let us make a better world for our industry!



Contact us

Tel: +86-755-8981 8866 Fax: +86-755-8427 6832

Email & Skype: info@chipsmall.com Web: www.chipsmall.com

Address: A1208, Overseas Decoration Building, #122 Zhenhua RD., Futian, Shenzhen, China



February.28,2012

Introduction to Grove

For more information go to: www.seeedstudio.com

Catalogue

| | |
|---|---|
| 1 Introduction to Grove | 1 |
| 1. Our Initiative | 1 |
| 2. What is Grove? | 1 |
| 3. Who is it for?..... | 1 |
| 2 How Grove functions? | 2 |
| 1. Grove Module Activation | 2 |
| 2. Functional Areas of the Base Shield..... | 4 |
| 3. Grove Categories..... | 6 |

1. Introduction to Grove

1. Our Initiative

We believe that electronics is fun and everyone, no matter what your background, is capable of building a successful electronics project. No one should be held back from bringing ideas to life because they are bogged down by soldering or debugging electronic circuits. We want to help. That is why we created the Grove system, an easy-to-use, plug-and-play tool set.

2. What is Grove?

Grove is a modulated, ready-to-use tool set. Much like Lego, it takes a building block approach to assembling electronics. Compared with the traditional, complicated learning method of using a breadboard and various electronic components to assemble a project, Grove simplifies and condenses the learning process significantly. The Grove system consists of a base shield and various modules with standardized connectors. The base shield allows for easy connection of any micro-processor input or output from the Grove modules, and every Grove module addresses a single function, such as a simple button or a more complex heart rate sensor. Each one comes with clear documentation and demo code to help you get started quickly.

Characteristics:

- 1) Affordable for everyone
- 2) Powerful tool set, including elements from inertial detection to wireless communication. Plus, we are always adding more.
- 3) Uniform interface, plug-and-play, no soldering required
- 4) Detailed documentation, an electronics background is not required
- 5) Perfect for prototyping

3. Who is it for?

Artists, makers, inventors, hobbyists, students and teenagers.

2. How Grove functions?

(an illustration having a lot of Grove elements plugged onto a Base Shield)

All Grove modules connect to the Grove – Base Shield, which is the **starting point** of your Grove journey. The base shield routes all of the pins from your microcontroller (e.g. Arduino) into 16 Grove sockets for instant, simple, solder-free connections. In this section, you will find a **general example** of how to activate a Grove module, an **illustration of different functional areas** on a base shield and an **introduction to all five categories of the Grove system**.

1. Grove Module Activation

What do you do the moment you get a new Grove module and unpack it? Simply plug the Grove module into the base shield and upload the sample code to your Arduino. This is as **OUT OF THE BOX** as you can get. That's the principle we keep in mind when writing our wiki pages. So generally, there are only **two steps** to get a Grove module rolling:

Plug it into the appropriate port

Upload the demo code/example

Check the result

Example: [How to gather temperature data from your environment?](#)

1) Plug the Grove – Temperature Sensor into one of the analog ports on the Grove - Base Shield. How do I know which port on the base shield to plug it into? The wiki page explains exactly which port is required.

"Connect the module to the Analog port 0 of Grove - Basic Shield using the 4-pin grove cable."

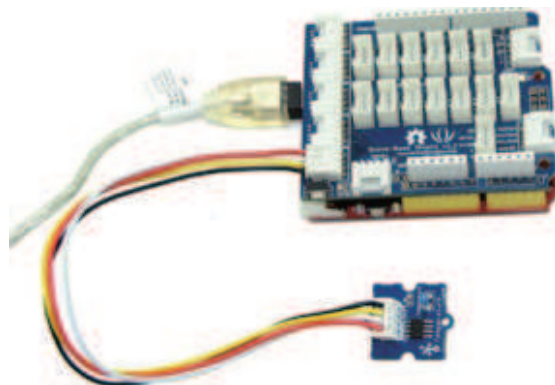

2. How Grove functions?

2) Copy and paste the demo code from the corresponding wiki page to a new Arduino sketch, and upload it to your Arduino.

```
/*
 * Grove - Temperature Sensor demo v1.0
 * This sensor detects the environment temperature,
 * Connect the signal of this sensor to A0, use the
 * Serial monitor to get the result.
 * By: http://www.seeedstudio.com
 */
#include <math.h>
int a;
float temperature;
int B=3975;           //B value of the thermistor
float resistance;

void setup()
{
  Serial.begin(9600);
}

void loop()
{
  a=analogRead(0);
  resistance=(float)(1023-a)*10000/a; //get the resistance of the sensor;
  temperature=1/(log(resistance/10000)/B+1/298.15)-273.15;//convert to temperature via datasheet ;
  delay(1000);
  Serial.print("Current temperature is ");
  Serial.println(temperature);
}
```

2. How Grove functions?

3) After successfully uploading the sketch, you can check the temperature data via the serial monitor.

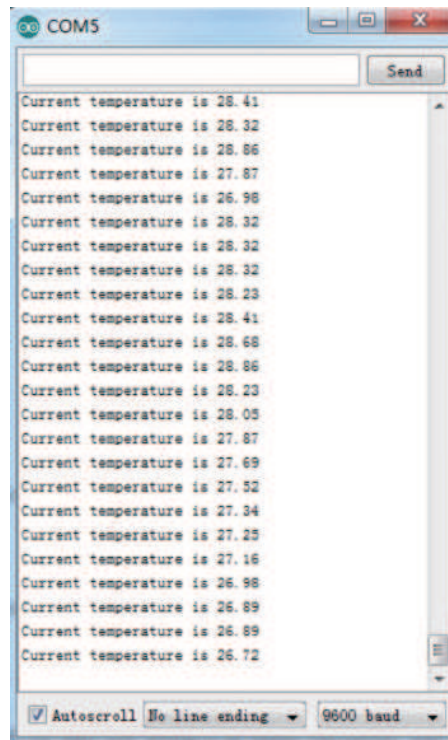

2. Functional Areas of the Base Shield

In this section, we will focus on the methodology of the Grove system. There are 16 Grove sockets on the base shield which can be divided into three different functional areas: digital ports (8), analog ports (4), and I2C ports (4). The Grove modules communicate via different protocols, such as I2C, and by familiarizing yourself with the communication methods of each module, figuring out where to plug them in will become second nature.

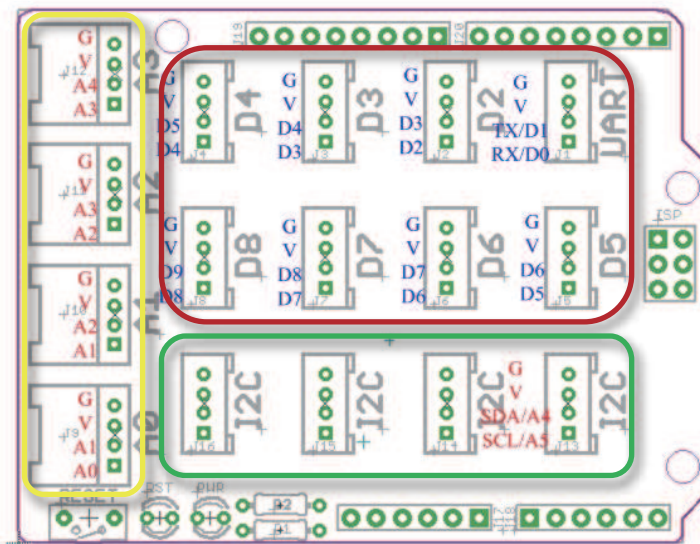

2. How Grove functions?

1) Digital Ports

Surrounded by the red lines are eight digital Grove ports. They are equivalent to digital pins 0 through 9 on the Arduino Uno. Normally, they are used when reading a digital sensor that only outputs 0 or 1 or turning on or off an actuator.

Some of these ports are multi-purpose and can function as PWM (pulse width modulation) outputs. They are port 3, port 5 and port 6. You will need these ports when driving a servo or fading an LED.

Digital ports are a must for serial communication too. There is one built-in hardwired serial port, AKA UART, on port 1. This is the Arduino's default port for serial communication with the PC. In cases where you need at least two serial devices or you need an available serial port for debugging purposes, other digital ports, software serial ports, can be used to replicate the function. We will encounter it a lot in our Grove system.

2) Analog Input Ports

On the left-hand side are four Grove ports for taking analog readings. Analog sensors can return readings ranging from 0 – 1024. Compared with digital sensors that only return 0 or 1, analog readings are more detailed and precise.

2) Analog Input Ports

On the left-hand side are four Grove ports for taking analog readings. Analog sensors can return readings ranging from 0 – 1024. Compared with digital sensors that only return 0 or 1, analog readings are more detailed and precise.

3) I2C Ports

Below the digital ports are four I2C Grove ports. I2C is a low-speed bus protocol that transfers data via two wires: SCL and SDA. SCL is the clock line that synchronizes data transfer over the I2C bus, and SDA is the data line. The following diagram illustrates the framework of an I2C bus.

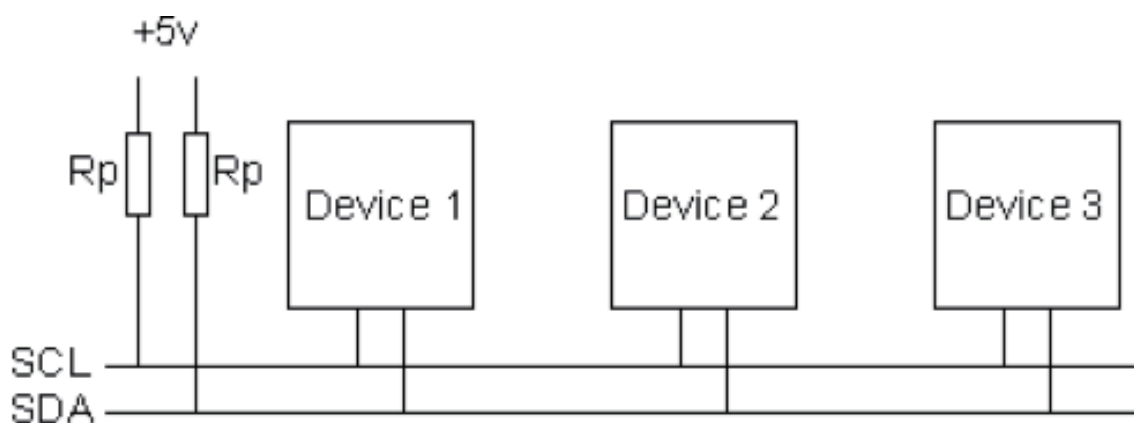

2. How Grove functions?

There is no limit to the amount of devices that can hang off of the I2C bus; however, only one of them can work in master mode, while all of the others work in slave mode. For Grove, the master is the Arduino. It generates the clock signal and sends commands to and/or receives data from all of the devices. In theory, each slave device should have a unique address.

I2C ports are generally used when the amount of data is overwhelming for simple digital and analog ports. For example, when we want to obtain complex information, such as angular acceleration, or read the real time from an RTC module, using the I2C bus is an inevitable option.

3. Grove Categories

As of this publication, we have developed 70 plus Grove modules covering a wide range of applications. They are classified into five categories: Environmental Sensors, Motion Sensors, Wireless Modules, User Interface Modules and Physical Sensors. Let's take a look at some of the features and specific applications available in each category.

1) Environmental Sensors

Have you ever wanted to get your daily weather report based on data from your garden instead of obtaining a more generic report from your TV or mobile phone? Sensors in this category help you monitor and report on your environment with minimal effort. They can also help you chart everyday fluctuations in temperature, measure air quality, sense light, and assess other elements in your immediate environment.



Light Sensor



Temperature Sensor



Gas Sensor



Dust Sensor

2) Motion Sensors

Sensors in this category enable your microcontroller to detect motion, location and direction. You can make the movement of your microcontroller understandable in three dimensional spaces or determine which direction is up with the help of a 3-axis accelerometer and compass.

2. How Grove functions?



3-Axis Digital Accelerometer (±16g)



3-Axis Digital Compass

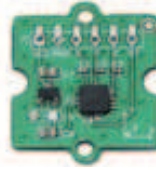

3-Axis Analog Accelerometer

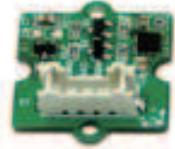

3-Axis Digital Accelerometer (±1.5g)

3) Wireless Modules

Communicating without wires is a cool feature that can spice up your project. Modules in this category arm your microcontroller with wireless communication ability such as RF, Bluetooth, etc.



433MHz Simple RF Link Kit



Serial Bluetooth



Infrared Receiver



GPS

4) User Interface Modules

Modules in this, our largest, category, let you interface with your microcontroller via input modules, such as touch pads, joysticks or your voice. Or you can choose output modules, like LED strips, motors or even an OLED display, to enhance your project. This is where the fun begins, as you get to interact with the fruits of your labor.



Thumb Joystick



Solid State Relay



OLED Display 96*96

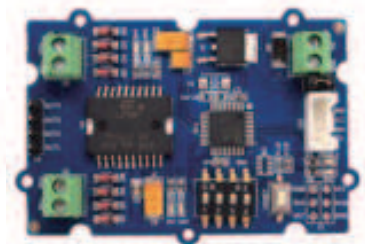

I2C Motor Driver

2. How Grove functions?

5) Physical Sensors

Scientists understand the world around us in physical dimensions. Modules in this category are designed to help you analyze the physical world. Measure your heart rate, detect the color of objects, or find out the amplitude of the current without dismantling your project. These modules provide an easy mechanism to gather this data without high-end expensive instruments.



Ear-clip Heart Rate Sensor



PIR Motion Sensor



Alcohol Sensor

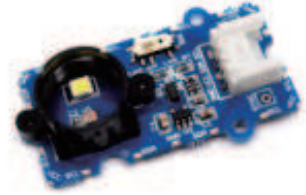

I2C Color Sensor