



Chipsmall Limited consists of a professional team with an average of over 10 year of expertise in the distribution of electronic components. Based in Hongkong, we have already established firm and mutual-benefit business relationships with customers from,Europe,America and south Asia,supplying obsolete and hard-to-find components to meet their specific needs.

With the principle of “Quality Parts,Customers Priority,Honest Operation,and Considerate Service”,our business mainly focus on the distribution of electronic components. Line cards we deal with include Microchip,ALPS,ROHM,Xilinx,Pulse,ON,Everlight and Freescale. Main products comprise IC,Modules,Potentiometer,IC Socket,Relay,Connector.Our parts cover such applications as commercial,industrial, and automotives areas.

We are looking forward to setting up business relationship with you and hope to provide you with the best service and solution. Let us make a better world for our industry!



Contact us

Tel: +86-755-8981 8866 Fax: +86-755-8427 6832

Email & Skype: info@chipsmall.com Web: www.chipsmall.com

Address: A1208, Overseas Decoration Building, #122 Zhenhua RD., Futian, Shenzhen, China



PRODUCT No.
10103958-001LF

VERICODE IDENTIFICATION:
(SERIAL NUMBER ID)

NOTES:

- MATERIAL:
HOUSING: LCP, BLACK, UL94 V-0
CONTACT: COPPER ALLOY
- FINISH:
0.76um MIN, MATTE TIN OVER
0.76um, NICKEL PLATING
- DATA MATRIX CODING
OF 8 DIGITS (8 DIGITS, HUMAN READABLE) SCALE 3:1
USING ALPHANUMERIC, EXCEPT I, O, U FOR 3rd-7th DIGIT,
USING NUMBER ONLY FOR 8th DIGIT (REFER DIAGRAM)
- PACKAGING TAPE AND REEL
- THE HOUSING WILL WITHSTAND
EXPOSURE TO 260° PEAK TEMPERATURE FOR 10 SECONDS
IN A CONVECTION, INFRA-RED OR VAPOR PHASE REFLOW OVEN.
- THIS PRODUCT MEETS EUROPEAN UNION DIRECTIVES AND
OTHER COUNTRY REGULATIONS AS DESCRIBED ON GS-22-008.
- APPROXIMATED LOCATION FOR
MATERIAL IDENTIFIER & FCI ID.

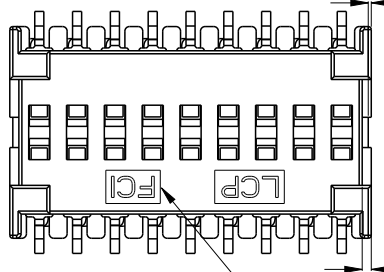
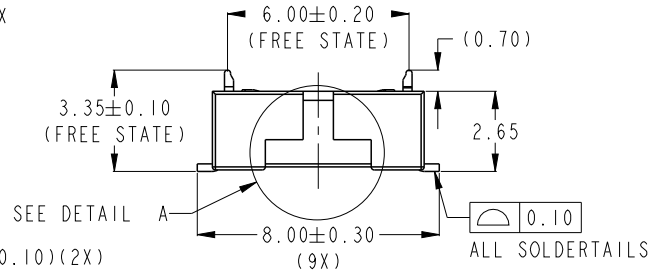
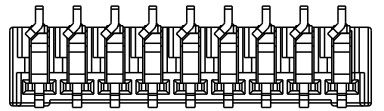
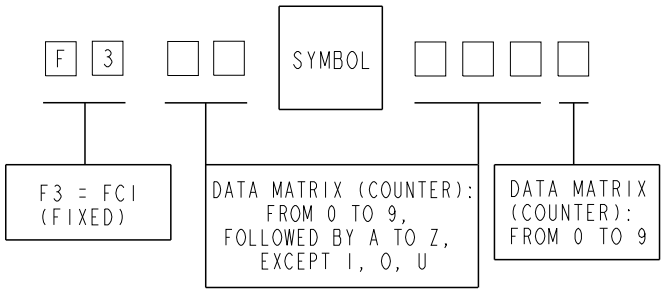
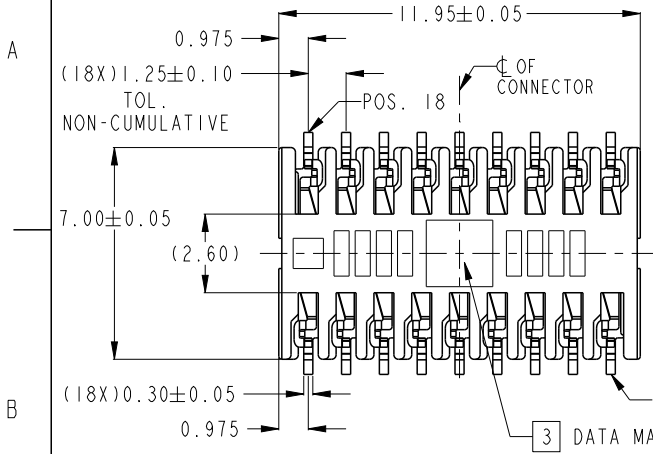
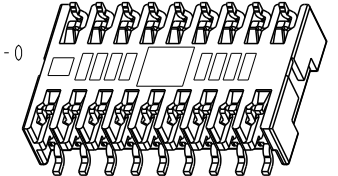

7 MATERIAL IDENTIFIER & FCI ID

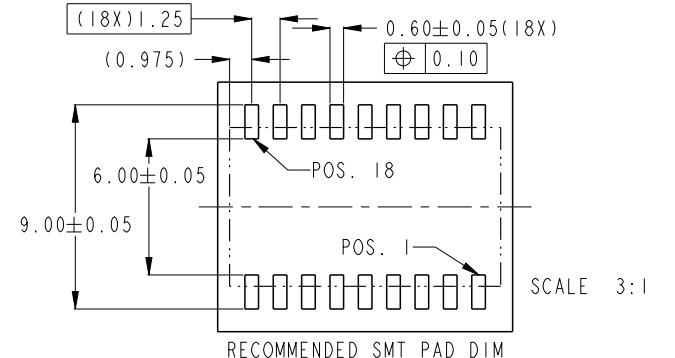
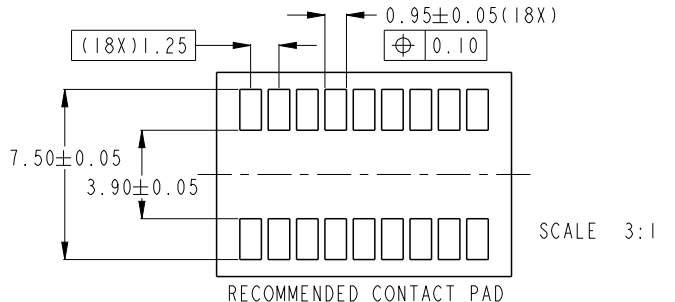
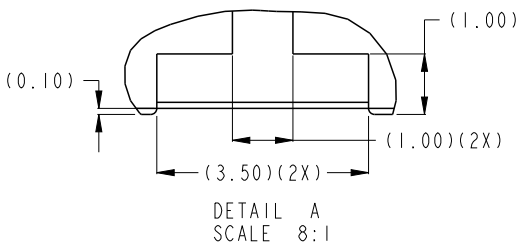

Copyright FCI.

spec ref	-	dr	Koon-Poh Tay	2011/08/18	projection	MM	size	A4	scale	4:1		
tolerance std	ASME Y14.5	eng	Dennis Goh	2014/10/08		←→	ecn no				ELX-S-18890-1	
TOLERANCES UNLESS OTHERWISE SPECIFIED		chr	-	-			rel level				Released	
surface	✓	appr	Chen-Hong Tan	2015/06/30	product family	-	dwg no		10103958	rev	C	
ASME Y14.5	linear	0.X	±0.20		title		COMPRESSION CONNECTOR		www.fci.com	cat. no.		-
		0.XX	±0.20		1.25mm PITCH		Product - Customer Drw			sheet 1 of 1		
	angular	0°	±2°				PDS: Rev :C			STATUS:Released		Printed: Jul 01, 2015

ProjE File - REV C - 2009-06-09