



Chipsmall Limited consists of a professional team with an average of over 10 year of expertise in the distribution of electronic components. Based in Hongkong, we have already established firm and mutual-benefit business relationships with customers from,Europe,America and south Asia,supplying obsolete and hard-to-find components to meet their specific needs.

With the principle of “Quality Parts,Customers Priority,Honest Operation,and Considerate Service”,our business mainly focus on the distribution of electronic components. Line cards we deal with include Microchip,ALPS,ROHM,Xilinx,Pulse,ON,Everlight and Freescale. Main products comprise IC,Modules,Potentiometer,IC Socket,Relay,Connector.Our parts cover such applications as commercial,industrial, and automotives areas.

We are looking forward to setting up business relationship with you and hope to provide you with the best service and solution. Let us make a better world for our industry!



Contact us

Tel: +86-755-8981 8866 Fax: +86-755-8427 6832

Email & Skype: info@chipsmall.com Web: www.chipsmall.com

Address: A1208, Overseas Decoration Building, #122 Zhenhua RD., Futian, Shenzhen, China



Part Number
10104109-0001LF

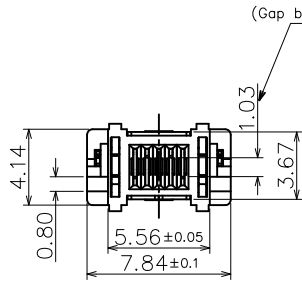

(Gap between Pin, PCB Thickness)

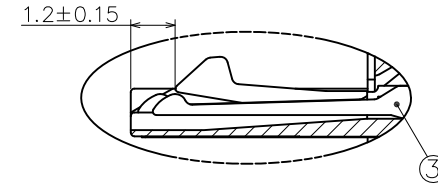
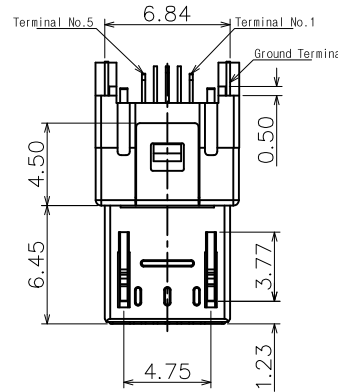
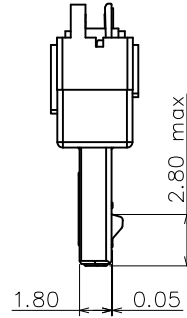
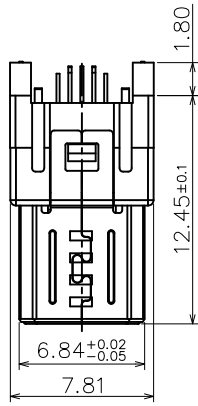
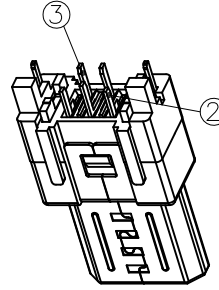
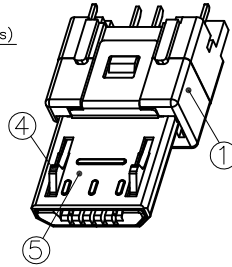

Plug Contact -A Point -2EA (No.2, No.4)
Plug Contact -B Point -1EA (No.3)

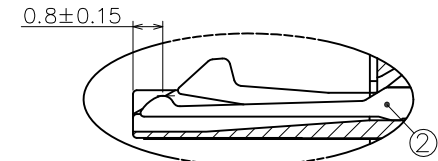

Plug Contact -B Point -2EA (No.1, No.5)

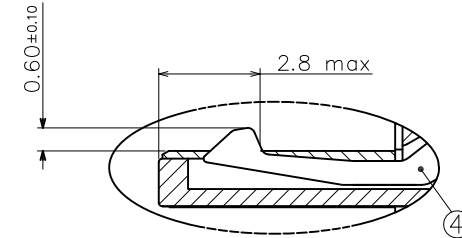

Plug Contact -LOCK TML' Point -2EA

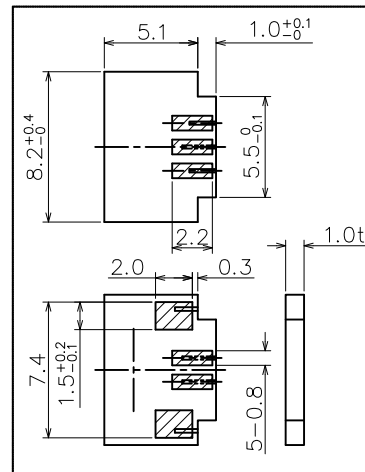
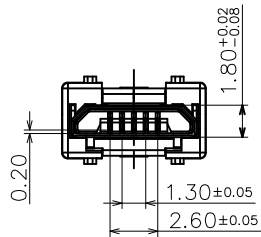

*PCB ref.
(Tolerance ±0.05)

-Note-

1. Material & finish: See table-1
2. Packing in tray

(Table-1)

No.	Part Name	Material	Finish	Remarks
1	Plug Housing	Thermoplastic	black	
2	Plug Contact -B	Copper alloy	Selective Gold Plated	
3	Plug Contact -A	Copper alloy	Selective Gold Plated	
4	Lock Plate	Sustainess steel		
5	Plug Shield	Sustainess steel	Ni Plated	

mat'l. code				tolerances unless otherwise specified		CUSTOMER COPY		FCI		www.fciconnect.com		
ltr	ecn no	dr	date	linear	.X ± 0.38	projection	title	MICRO-USB B-TYPE PLUG				
A	T10-0002	J.H	01/07/10		.XX ± 0.25							
					.XXX ± 0.10							
				angles	0° ±2°	MM	product family	USB	code	TWN		
				dr	JASON HSU							01/07/10
				enr	JASON HSU							01/07/10
				chr	GARY HSIEH	01/07/10	scale	A4	10104109	sheet		
				appd	JOSEPH HSIA	01/07/10				1 of 1		
sheet index	revision sheet	A	1									