



Chipsmall Limited consists of a professional team with an average of over 10 year of expertise in the distribution of electronic components. Based in Hongkong, we have already established firm and mutual-benefit business relationships with customers from,Europe,America and south Asia,supplying obsolete and hard-to-find components to meet their specific needs.

With the principle of “Quality Parts,Customers Priority,Honest Operation,and Considerate Service”,our business mainly focus on the distribution of electronic components. Line cards we deal with include Microchip,ALPS,ROHM,Xilinx,Pulse,ON,Everlight and Freescale. Main products comprise IC,Modules,Potentiometer,IC Socket,Relay,Connector.Our parts cover such applications as commercial,industrial, and automotives areas.

We are looking forward to setting up business relationship with you and hope to provide you with the best service and solution. Let us make a better world for our industry!



## Contact us

Tel: +86-755-8981 8866 Fax: +86-755-8427 6832

Email & Skype: info@chipsmall.com Web: www.chipsmall.com

Address: A1208, Overseas Decoration Building, #122 Zhenhua RD., Futian, Shenzhen, China



PRODUCT NUMBER  
SEE PART NO. TABLE

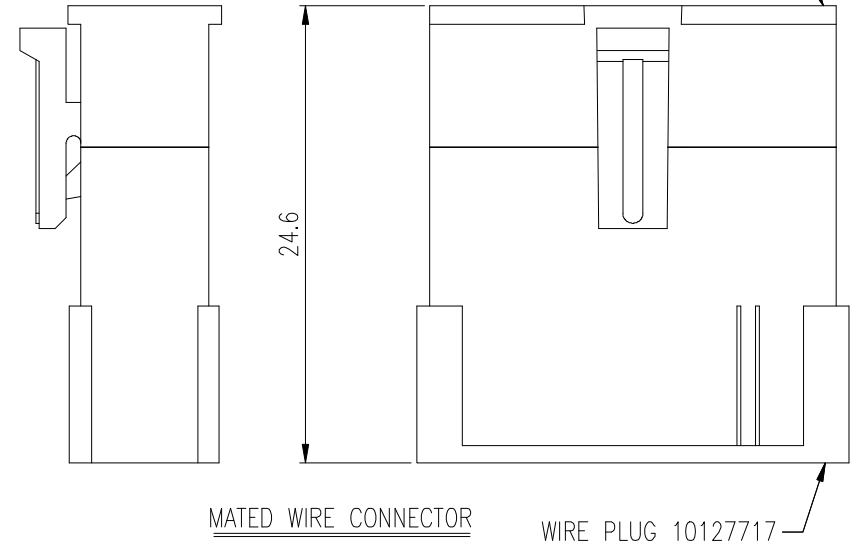
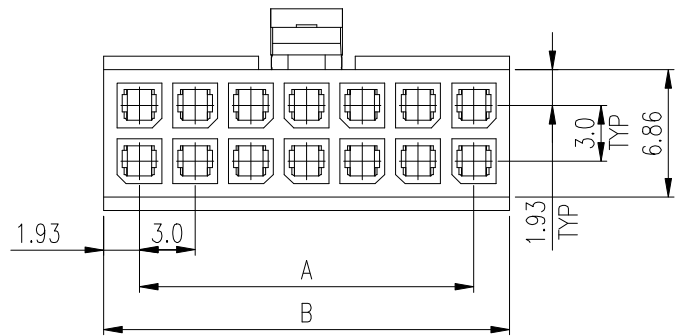
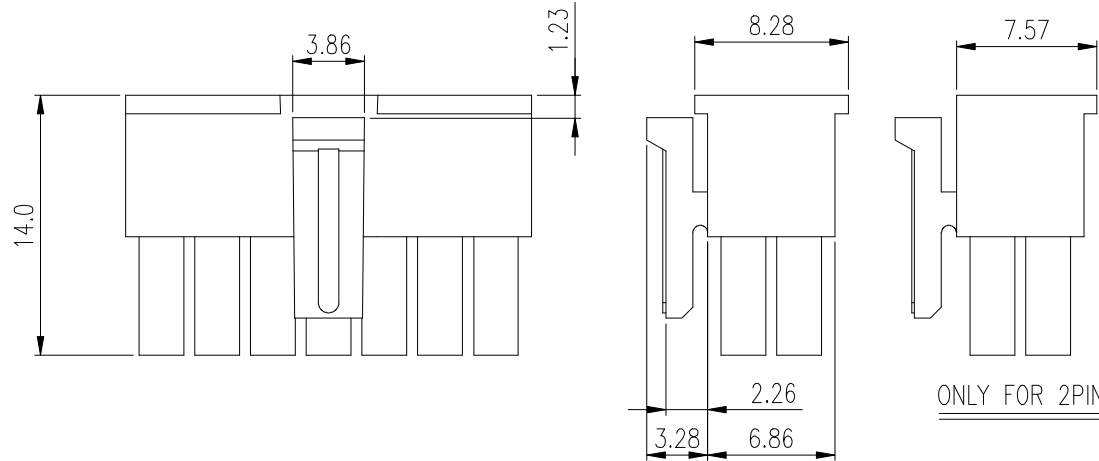
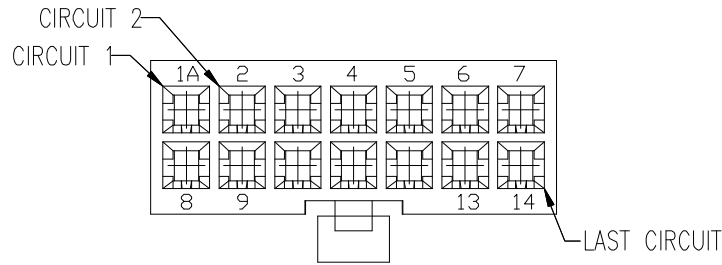

NOTES:

1. MATERIAL: NYLON 66, UL 94V-0, BLACK.
2. THIS HSG IS USED WITH FCI RECEPTACLE TERMINAL 10127718.
3. THIS RECEPTACLE MATES WITH FCI PLUG 10127717, 10127720 & 10127721.
4. PRODUCT SPECIFICATION: GS-12-1177.
5. PACKAGE SPECIFICATION: GS-14-2359.
6. PART NUMBER SCHEME:  
10127716- XX LF

POS. CODE:  
02: 2 POS.  
04: 4 POS.  
5  
24: 24 POS.

DIMENSIONAL & PART NO. TABLE:

PART NO.	POS	A	B
10127716-02LF	2	3.85	3.85
10127716-04LF	4	3.0	6.85
10127716-06LF	6	6.0	9.85
10127716-08LF	8	9.0	12.85
10127716-10LF	10	12.0	15.85
10127716-12LF	12	15.0	18.85
10127716-14LF	14	18.0	21.85
10127716-16LF	16	21.0	24.85
10127716-18LF	18	24.0	27.85
10127716-20LF	20	27.0	30.85
10127716-22LF	22	30.0	33.85
10127716-24LF	24	33.0	36.85

mat'l. code		surface		tolerance		projection		product family	
ltr		ecn no		dr		date		tolerances unless otherwise specified	
A		TAI		2013-10-21		angles		X.X ±0.3	
						line		X.XX ±0.2	
						X*±2°		scale	
		dr		KENNY TAI		2013-10-21		scale	
		enr		KENNY TAI		2013-10-21		FCI	
		chr		KENNY TAI		2013-10-21		dwg no	
		appd		PM ZHENG		2013-11-06		sheet 1 of 2	
sheet index		revision sheet		A 1		A 2		size	
								10127716	
								CUSTOMER Drawing	

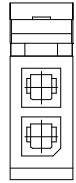

2 POS

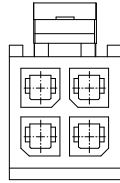

4 POS

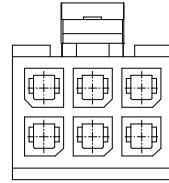

6 POS

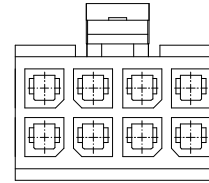

8 POS

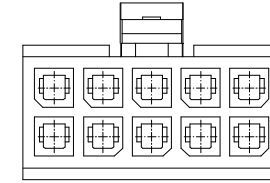

10 POS

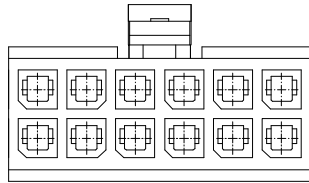

12 POS

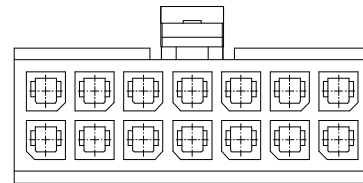

14 POS

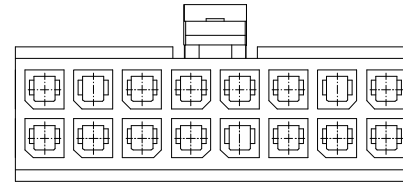

16 POS

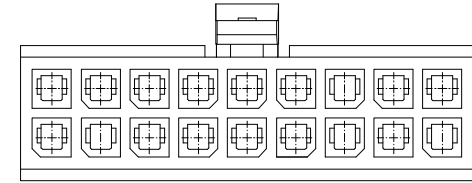

18 POS

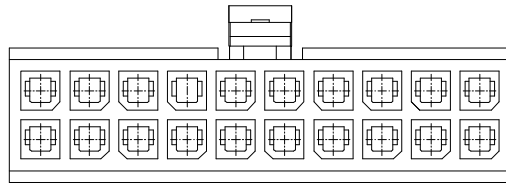

20 POS

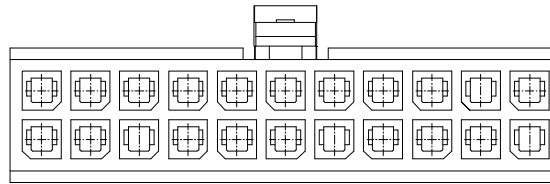

22 POS

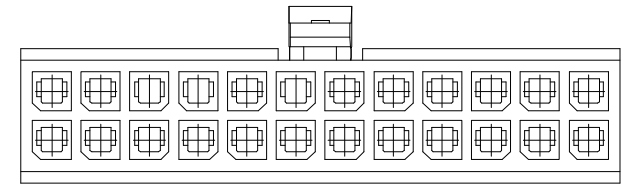

24 POS

mat'l. code		surface <input checked="" type="checkbox"/>		tolerance		projection		product family	
ltr		ecn no		dr		date		title	
								RECEPTACLE HSG, DUAL ROW, FOR 3mm PITCH WIRE CONNECTOR	
				angles		X.X ±0.3		scale	
						X.XX ±0.2		MM	
				X*±2°				scale	
				dr		KENNY TAI 2013-10-21		dwg no	
				enr		KENNY TAI 2013-10-21		sheet 2 of 2	
				chr		KENNY TAI 2013-10-21		size	
				appd		PM ZHENG 2013-11-06		A4	
sheet index		revision sheet		A		A		type	
				1		2		CUSTOMER Drawing	

