



Chipsmall Limited consists of a professional team with an average of over 10 year of expertise in the distribution of electronic components. Based in Hongkong, we have already established firm and mutual-benefit business relationships with customers from,Europe,America and south Asia,supplying obsolete and hard-to-find components to meet their specific needs.

With the principle of “Quality Parts,Customers Priority,Honest Operation,and Considerate Service”,our business mainly focus on the distribution of electronic components. Line cards we deal with include Microchip,ALPS,ROHM,Xilinx,Pulse,ON,Everlight and Freescale. Main products comprise IC,Modules,Potentiometer,IC Socket,Relay,Connector.Our parts cover such applications as commercial,industrial, and automotives areas.

We are looking forward to setting up business relationship with you and hope to provide you with the best service and solution. Let us make a better world for our industry!



Contact us

Tel: +86-755-8981 8866 Fax: +86-755-8427 6832

Email & Skype: info@chipsmall.com Web: www.chipsmall.com

Address: A1208, Overseas Decoration Building, #122 Zhenhua RD., Futian, Shenzhen, China



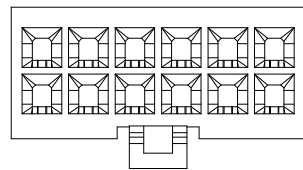
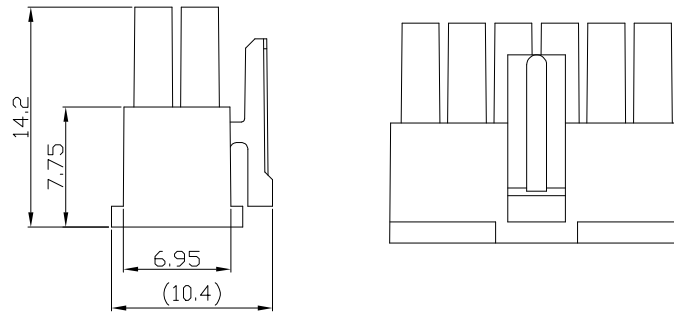
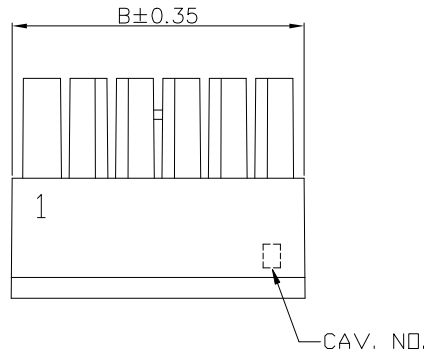
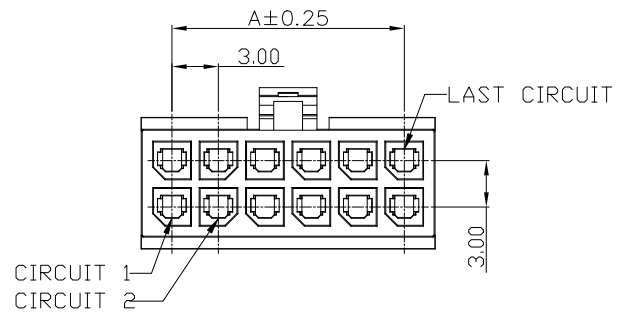

COLOR TABLE	
BLANK	BLACK
0	WHITE
1	BROWN
2	RED
3	ORANGE
4	YELLOW
5	GREEN
6	BLUE
7	PURPLE
8	GREY
9	DARK RED
C	CREAM

NOTES:

1. MATERIAL: HIGH TEMP. THERMOPLASTIC, UL 94V-0, BLACK.
2. THIS HSG IS USED WITH FCI RECEPTACLE TERMINAL 10132447.
3. THIS RECEPTACLE MATES WITH FCI PLUG 10132446, 10132449 & 10132450.
4. PRODUCT SPECIFICATION: GS-12-1291.
5. PACKAGE SPECIFICATION: GS-14-2419.
6. PART NUMBER SCHEME:
10132445- XX XLF

POS. CODE:
 02: 2 POS.
 04: 4 POS.
 5
 24: 24 POS.

DIMENSIONAL & PART NO. TABLE:

PART NO.	POS	A	B
10132445-02LF	2	3.85	
10132445-04LF	4	6.85	
10132445-06LF	6	6.0	9.85
10132445-08LF	8	9.0	12.85
10132445-10LF	10	12.0	15.85
10132445-12LF	12	15.0	18.85
10132445-14LF	14	18.0	21.85
10132445-16LF	16	21.0	24.85
10132445-18LF	18	24.0	27.85
10132445-20LF	20	27.0	30.85
10132445-22LF	22	30.0	33.85
10132445-24LF	24	33.0	36.85

mat'l. code		surface ISO 1302 ✓		tolerance ISO 406 ISO 1101		projection		product family	
A		TAI 2015-02-25		tolerances unless otherwise specified		mm		MINITEK PWR3.0	
B		ELX-N-28240 TONY 2017-10-24		angles linear		scale 1:1		title	
				0°±3'				MINITEK PWR3.0 REC. HSG HIGH CURRENT	
				dr KENNY TAI 2015-02-03		Amphenol FCI		dwg no	
				engr KENNY TAI 2015-02-03				sheet 1 of 3	
				chr KENNY TAI 2015-02-03				10132445	
				appd PM ZHENG 2015-02-25				size	
								A3	
sheet index		revision sheet		B B B				type Product Customer Drawing	
		1 2 3							

2 POS.

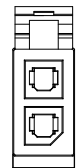

10 POS.

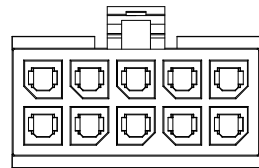

18 POS.

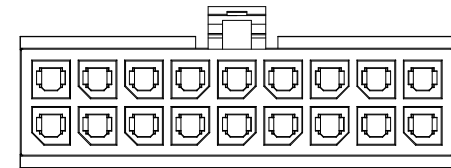

4 POS.

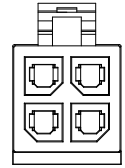

12 POS.

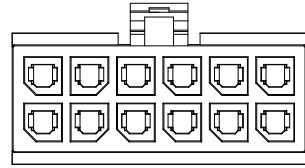

20 POS.

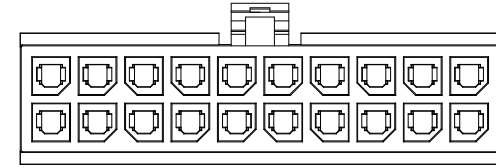

6 POS.

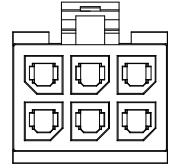

14 POS.

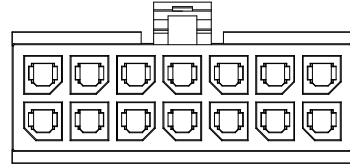

22 POS.

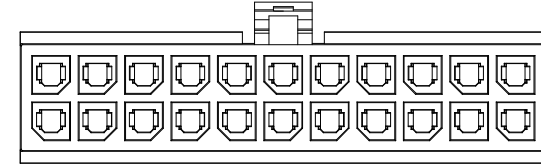

8 POS.

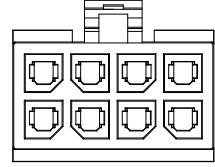

16 POS.

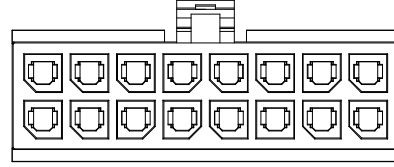

24 POS.

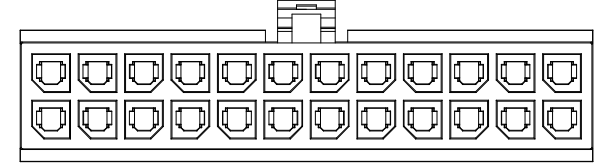

mat'l. code		surface		tolerance		projection		product family	
		ISO 1302 ✓		ISO 406 ISO 1101				MINITEK PWR3.0	
ltr		ecn no		dr		date		title	
								MINITEK PWR3.0 REC. HSG HIGH CURRENT	
								dwg no	
								sheet 2 of 3	
								size	
								A3	
								type	
								Product Customer Drawing	
sheet		revision		B		B			
index		sheet		1		2		3	

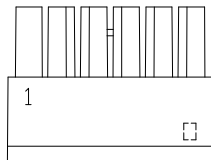

CONNECTOR

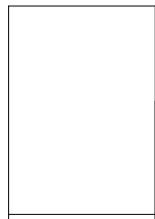

BAG

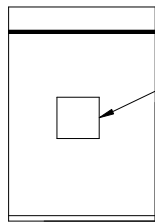

LABEL

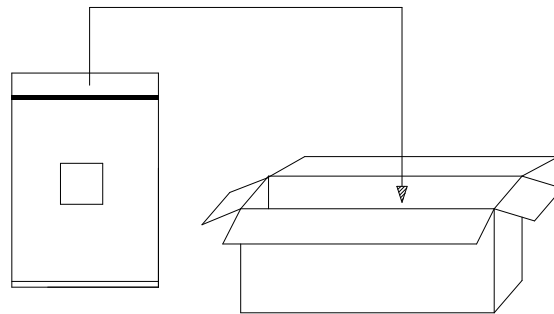

CARTON:450*370*250mm

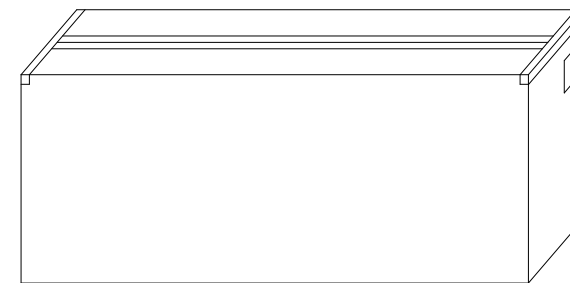

LABEL

PACKING MATERIAL		
PART NAME	PIN	DIM.(mm)
PE BAG	2	0.08*160*240
	4	0.08*180*260
	6~14	0.08*210*270
	16~22	0.08*240*310
	24	0.08*210*270

PACKING CAPACITY			
PIN	PCS/BAG	BAG/BC	PCS/BC
2~6	1,000	16	16000
8~10	1,000	12	12000
12~22	500	12	6000
24	200	12	2400

mat'l. code		surface	tolerance	projection	product family
		ISO 1302 ✓	ISO 406 ISO 1101		MINITEK PWR3.0
ltr	ecn no	dr	date	tolerances unless otherwise specified	title
				linear	MINITEK PWR3.0 REC. HSG HIGH CURRENT
				angles	mm
				0°±3'	scale 1:1
				dr	KENNY TAI 2015-02-03
				engr	KENNY TAI 2015-02-03
				chr	KENNY TAI 2015-02-03
				appd	PM ZHENG 2015-02-25
sheet index	revision sheet	B 1	B 2	B 3	Amphenol FCI
					dwg no 10132445 sheet 3 of 3 size A3
					type Product Customer Drawing