



Chipsmall Limited consists of a professional team with an average of over 10 year of expertise in the distribution of electronic components. Based in Hongkong, we have already established firm and mutual-benefit business relationships with customers from,Europe,America and south Asia,supplying obsolete and hard-to-find components to meet their specific needs.

With the principle of “Quality Parts,Customers Priority,Honest Operation,and Considerate Service”,our business mainly focus on the distribution of electronic components. Line cards we deal with include Microchip,ALPS,ROHM,Xilinx,Pulse,ON,Everlight and Freescale. Main products comprise IC,Modules,Potentiometer,IC Socket,Relay,Connector.Our parts cover such applications as commercial,industrial, and automotives areas.

We are looking forward to setting up business relationship with you and hope to provide you with the best service and solution. Let us make a better world for our industry!



Contact us

Tel: +86-755-8981 8866 Fax: +86-755-8427 6832

Email & Skype: info@chipsmall.com Web: www.chipsmall.com

Address: A1208, Overseas Decoration Building, #122 Zhenhua RD., Futian, Shenzhen, China



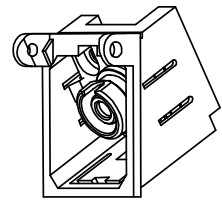
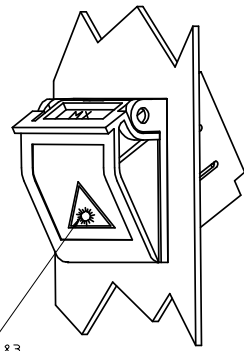
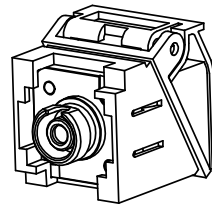
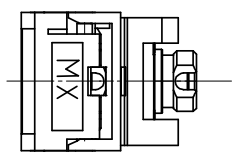
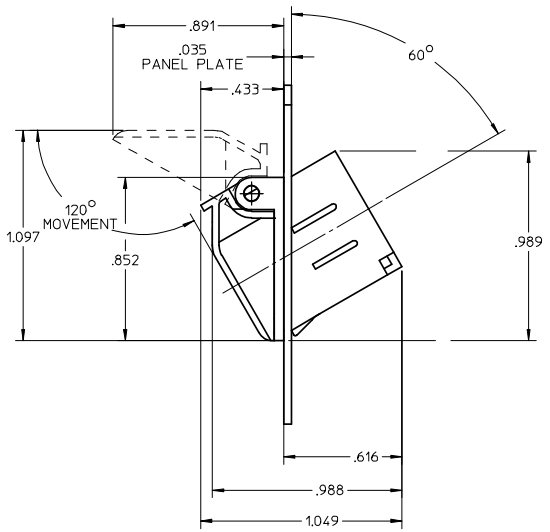

LABEL
SEE NOTES 2 & 3

DOOR REMOVED

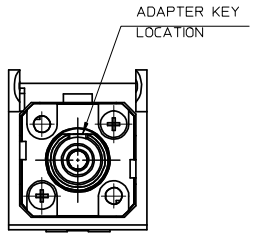

DOOR REMOVED

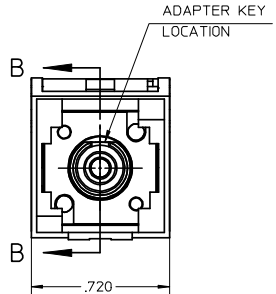
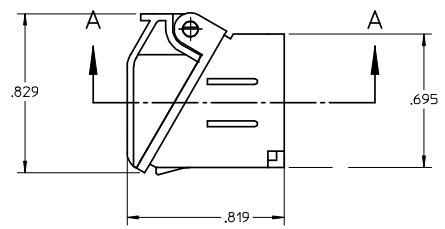

SECTION B-B

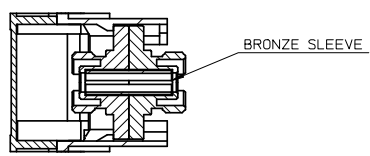

SECTION A-A

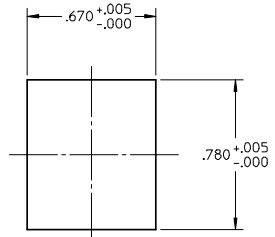

RECOMMENDED
MOUNTING HOLE
IN THE PANEL PLATE

- NOTES:
1. ALL DIMENSIONS ARE FOR REFERENCE ONLY.
 2. LABEL AND ADAPTER SHOULD BE PACKAGED TOGETHER IN A POLY BAG.
 3. LABEL TO BE INSTALLED ON THE DOOR BY USER.

ENTER DESCRIPTION EC NO: MF2008-0399 DRWN: SZEWCZYK 2008/03/31 CHKD: 2008/03/31 APPR: KATARZIENE 2008/03/31	QUALITY SYMBOLS 	GENERAL TOLERANCES (UNLESS SPECIFIED)		DIMENSION STYLE INCH ONLY	SCALE 2:1	DESIGN UNITS INCH	THIRD ANGLE PROJECTION	
		4 PLACES ± --- ± --- 3 PLACES ± --- ± --- 2 PLACES ± --- ± --- 1 PLACE ± --- ± ---	mm INCH INCH mm	DRAWN BY DATE PGIBLIN 2005/11/08	TITLE FC/FC SMPX BEZEL ADPT,PU KIT W/PUSH TAB (BLACK)			
		APPROVED BY DATE		MATERIAL NO. 1060043261			DOCUMENT NO. SD-106004-3261	SHEET NO. 1 OF 1
		DRAFT WHERE APPLICABLE MUST REMAIN WITHIN DIMENSIONS		MOLEX INCORPORATED THIS DRAWING CONTAINS INFORMATION THAT IS PROPRIETARY TO MOLEX INCORPORATED AND SHOULD NOT BE USED WITHOUT WRITTEN PERMISSION				