



Chipsmall Limited consists of a professional team with an average of over 10 year of expertise in the distribution of electronic components. Based in Hongkong, we have already established firm and mutual-benefit business relationships with customers from,Europe,America and south Asia,supplying obsolete and hard-to-find components to meet their specific needs.

With the principle of "Quality Parts,Customers Priority,Honest Operation,and Considerate Service",our business mainly focus on the distribution of electronic components. Line cards we deal with include Microchip,ALPS,ROHM,Xilinx,Pulse,ON,Everlight and Freescale. Main products comprise IC,Modules,Potentiometer,IC Socket,Relay,Connector.Our parts cover such applications as commercial,industrial, and automotives areas.

We are looking forward to setting up business relationship with you and hope to provide you with the best service and solution. Let us make a better world for our industry!



Contact us

Tel: +86-755-8981 8866 Fax: +86-755-8427 6832

Email & Skype: info@chipsmall.com Web: www.chipsmall.com

Address: A1208, Overseas Decoration Building, #122 Zhenhua RD., Futian, Shenzhen, China



DS203 USER'S MANUAL

Contents

1. Introduction	
Major Features	2
Safety	2
Operation conditions	2
General Inspection	3
Functional Inspection	3
Firmware Upgrade	3
2. Oscilloscope Operations	
Interfaces and Buttons	4
Screen Display	5
Fields in the Input Area	6
Fields in the Output Area	6
Fields in the Measurement Area	7
Parameter Menu	7
Disk Menu	9
3. Application Examples	
Example 1. Measure simple signals	10
Example 2. Acquire a single trace	10
Example 3. Measure with cursors	11
Example 4. Compare waveforms	12
Example 5. Save waveform images	13
4. Tips	15

1. Introduction to DSO203 Oscilloscope

DS203 is a pocket size 4-channel digital storage oscilloscope for common electronic engineering tasks. Its CPU is an ARM Cortex M3, STM32VCT6, with an AD9288-40 dual A/D converter sampling at 72 MHz, and a customer FPGA to manage the ADC and data buffering. A built-in 2MB USB disk enables you to store waveforms and to upgrade firmware. It also provides 4 application areas, convenient for users to load and upgrade at most 4 different application firmware. Schematics and source files are open-sourced to encourage improvements and innovations.

Major Features

This pocket-size oscilloscope DSO203 helps you test electronic devices, and measure relevant electronic signal. Its features include:

- Full color 3" TFT LCD display, 400x240 pixels.
- 8 MHz ADC bandwidth, 8-bit precision.
- 2 analog channels: (CH_A, CH_B) and 2 digital channels (CH_C, CH_D).
- Integrated Square/Sine/Triangle/Sawtooth signal generator.
- Calculation channels: [CH_A]+[CH_B], [CH_A]-[CH_B], Logic OR [CH_C]||[CH_D], Logic AND [CH_C]&[CH_D], REC_A, REC_B, REC_C, REC_D.
- Maximum sampling rate of a single analog channel, 72 MS/s.
- Maximum record length of any channel, 4096 points.
- Waveforms and upgrade firmware can be stored in built-in 2M USB disk.
- Rechargeable battery powered by USB connection.
- Comprehensive user interface through 6 buttons/switches and colored menu control system.
- 2 mcx 1X/10X oscilloscope probes.

Safety

To ensure your safety & avoid any damage to the device/connected products, please read the following precautions carefully. To avoid any possible dangers, please use this product according to the following rules.

- **Avoid fire and physical injury.**
- **Use supplied USB cord for power.**
- **Connect and disconnect properly.** Do not plug/unplug when the probe(s)/test lead(s) is connected to the voltage sources. Before you plug/unplug current probes, disconnect power to the circuit-under-test.
- **Observe all terminal ratings.** To avoid fire/electric shock, please observe ratings & symbols on the product. Please read the user's manual carefully to determine the ratings before connecting the device.
- **Do not operate in humid environment.**
- **Do not operate in inflammable/explosive environment.**
- **Keep the surface of the product clean and dry.**

Operation Conditions

- Temperature: Operating Condition: 0 to +50°C; Non-operating Condition: -20 to +60 °C.
- Humidity: Operating Condition: high temperature: 40 to 50 °C, 0 to 60% RH; Operating Condition: low temperature: 0 to 40 °C, 10 to 90%RH; Non-operating Condition: high temperature: 40 to 60 °C, 5 to 60% RH; Non-operating Condition: low temperature: 0 to 40 °C, 5 to 90% RH
- Electrical Ratings: Max transient voltage, ± 400 V peak; Measure voltage range, ± 15 V peak;

Max input voltage of logic probe, ± 15 V peak; Measurement frequency range, 8 MHz.

General Inspection

When you first receive a new DS203 oscilloscope, inspect it by following steps:

1. Inspect shipping damage. If the packaging carton or protection pad is seriously damaged, keep the package for returning.
2. Inspect the oscilloscope. Contact us for following problems: (1) surface of device is damaged; (2) device does not work; and (3) device doesn't pass performance test. If damage is resulted from shipping, please keep the container and inform the shipping company responsible for shipping this service.
3. Call RIGOL distributor to arrange for repair/change.

Functional Inspection

1. Take DSO203 out of the shipping box and remove plastic wrapping. Return the device if there are signs of damage.
2. Turn on the POWER switch. The homepage of the DSO203 will be displayed.
3. If DSO203 does not turn on, connect it to a computer through supplied USB cable to recharge the battery, until the red charging LED turns off.
4. Connect one probe to the WAVE_OUT channel, and another probe to the CH_A channel. Make sure that both probes are set at 1X setting. Turn on DSO203, and it will show the homepage, with a square wave at 20KHz, $V_{pp}=5V$.
5. Check whether the measured values are consistent with standard values. Check CH_B, CH_C and CH_D.

Firmware Upgrade

Connect the DSO203 to your PC with a mini USB cable. Hold down the Run  button while turning on DSO203. It is now in firmware upgrade mode, and a USB disk should appear on your PC. Copy the firmware files one at a time. After a file is copied, disconnect DSO203. When DSO203 reconnects, the file you copied will be updated.

The order that you upload the files is very important. Start by uploading the .hex files. Their order is not important. To upload the .BIN files, you need to first upload the corresponding .ADR file. This tells DSO203 where to put the binary file. Upload CFG_FPGA.ADR first, and then upload xxxxFPGA.BIN immediately after. If you make a mistake, delete all the files and start again.

When you're finished uploading all the firmware files, turn off DSO203 to complete the upgrading. When you boot up DSO203 again, your firmware should be updated. If you get an error message screen, try uploading the firmware again, carefully following the instructions above.

To upgrade the firmware, please follow these steps:





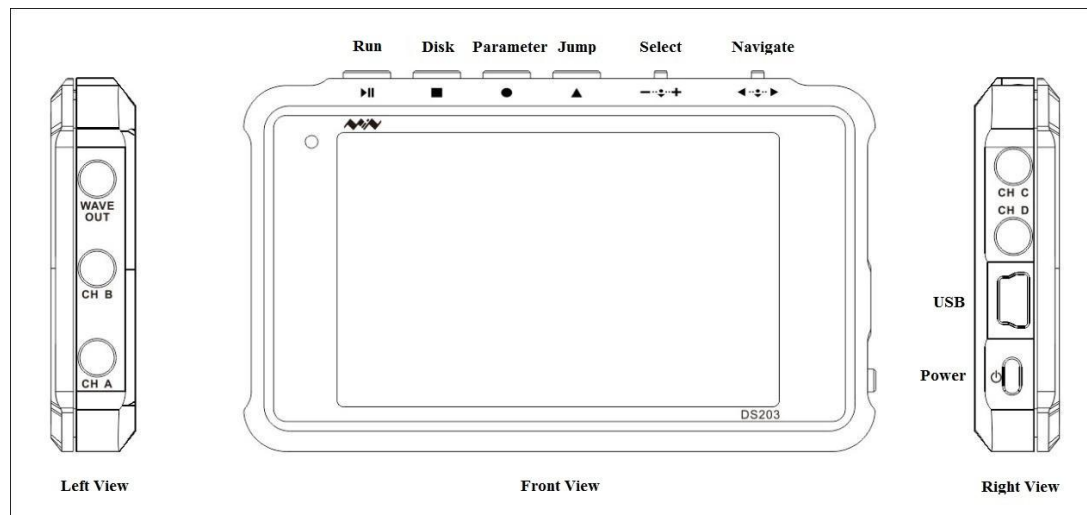

1. Open Web to access www.minidso.com, download the latest firmware of your oscilloscope to your PC.
2. Hold down the RUN/HOLD switch  of DS203 and simultaneously turn on POWER to enter DFU Firmware Upgrade Mode.
3. Connect DS203 to your PC through the supplied USB cable. A removable disk named "DFU V3_10_D" will appear on your PC. Copy the firmware to the root directory of this disk. Restart DS203 and the firmware is upgraded.

2. Operating DSO203 Oscilloscope

Interfaces and Buttons.

DSO203 is a pocket size Digital Storage Oscilloscope, measured about 4"x2-1/2"x1/2". Its front view and side views are shown in the following figure:









On the top edge, there are four buttons, as seen from left to right: Run , Disk , Parameter , Jump ; and then two rocker switches: Select , and Navigate .

On the left side, there are three sockets. From top to bottom, they are Wave Output (WAVE OUT), Analog Channel B Input (CH_B), and Analog Channel A Input (CH_A).

On the right side, from top to bottom, there are two sockets for Digital Channel C Input (CH_C), Digital Channel D Input (CH_D), a Mini USB port, and a Power Switch.

Functions of these buttons, switches and sockets are summarized in the following table:

Interface	Symbol	Function
Run		Button to run and stop DSO sampling
Disk		Button to save traces to built-in USB disk or restore traces from disk
Parameter		Button to display selected parameters
Jump		Button to jump among Input, Output, and Measurement Areas
Select		Rocker switch to scroll left or right to select a parameter. Press down to confirm selection.
Navigate		Rocker switch to scroll left or right to navigate to a selected field. Press down to confirm selection.
Wave Output	WAVE OUT	Socket for output waveforms
Channel A	CH_A	Socket for analog input channel A
Channel B	CH_B	Socket for analog input channel B
Channel C	CH_C	Socket for digital input channel C
Channel D	CH_D	Socket for digital input channel D
USB Port	---	Mini USB socket to connect to a PC
Power		Side switch to turn power on and off

Screen Display

DSO203 has a 3" full color TFT LCD display to show waveforms and all relevant information. It is a challenging task to place all the information on such a small display, and it is also difficult for the user to navigate through the maze of menus and functions with only 6 buttons.

When DSO203 is turned on, a very busy screen is flashed on the screen as shown below:

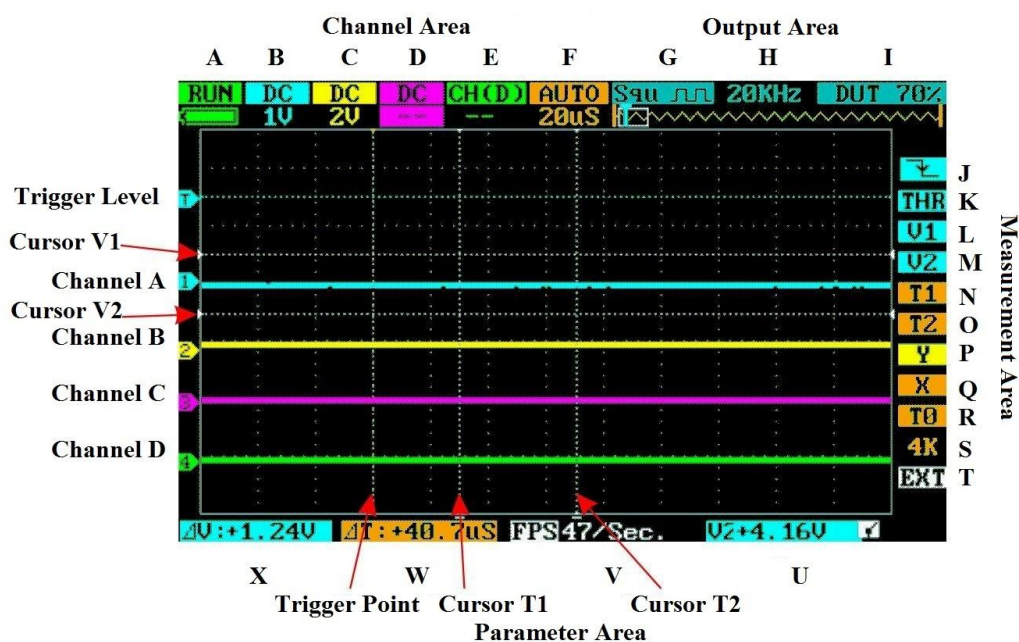





A large area in the middle of the DSO203 screen is dedicated to display 4 colored waveform traces: a blue trace for Channel A, a yellow trace for Channel B, a purple trace for Channel C and a green trace for Channel D. The color coding is very important and very convenient. There are many fields with alphanumeric information displayed in color. If a field is related to the four input channels, it has the corresponding color to give you a clue as to the attributes of this particular field.



The four heavy colored signal traces are displayed on a black background with very light grids in 5mm spacing. In addition, there are 6 cursors in single pixel dotted lines. Two horizontal cursors show voltages V1 and V2. One horizontal cursor shows the triggering level THR. Two vertical cursors show timing marks T1 and T2. A third vertical cursor shows the triggering point T0.

On the top edge of the display is an Input Area, divided into 6 fields from A to F, showing attributes of these 4 traces, and an Output Area from G to I, showing attributes of the output wave sent out of the output socket. On the right edge is the Measurement Area, divided into 11 fields from J to T, allowing parameters to be selected and to be modified. On the bottom is the Parameter Area, divided into 4 fields from U to W, showing values of parameters selected for displaying.

The rocker switch Navigate $\leftarrow \downarrow \rightarrow$ is used to navigate through these fields in the Input, Output and Measurement Area. The cursor is a currently selected field, flashing on and off to indicate that it is selected and ready for change. The rocker switch Select $\leftarrow \downarrow \rightarrow \oplus$ is then scrolled left or right to change value in the selected field.

Navigate  only moves the selected fields within one area. The Jump  button allows jumping from one area to another. Once jumped into an area, the Navigate switch  will only move selected Menu in the same area, until the Jump Button is pressed.

To enter the Output Area to change fields H and I, you must first move to Field G and then press the Select switch  to navigate among the G-I fields in the Output Area. Then scroll the Select rocker switch  left or right to change values.

The Fields B to F in the Input Area have upper and lower halves. Hold down the Select switch  for 2 seconds will switch between the upper and lower halves. Then scroll the Select rocker switch  left or right to change its value.

The lower part of the Output Area shows the current contents of the memory buffer. A rectangle shows the portion of the memory buffer which is currently displayed on the DSO screen. This rectangle can be moved using the T0 field in the Measurement Area.

Fields in the Input Area

Fields and their functions in the Input Area

Field	Name	Functions
A	RUN/HOLD	Running Mode: Run/Hold. Press Run button to change. Battery charge
B	AC/DC 50mV-10V	Channel A: AC Coupling/DC Coupling/Hide Voltage per grid, in 1-2-5 steps
C	AC/DC 50mV—10V	Channel B: AC Coupling/DC Coupling/Hide Voltage per grid, in 1-2-5 steps
D	DC	Channel C: DC Coupling/Hide
E	CH_(D)/(A+B)/(A-B)/(C&D)/(C D)/REC_A/R EC_B/ REC_C/REC_D	Channel D: Channel D/ (CH_A+ CH_B)/(CH_A-CH_B)/ (CH_A AND CH_B)/CH_A OR CH_B/Last CH_A Record/ Last CH_B Record/ Last CH_C Record/ Last CH_D Record
F	AUTO/NORM/SINGL/ NONE/SCAN 0.1uS—1S	Sync mode Auto: Refresh display, synchronize when triggered. Norm: Display synchronized waveform only when triggered. Single: Display triggered waveform and hold, blank before trigger None: Refresh unsynchronized waveform, ignoring triggering. Scan: Repeatedly sweep waveform from screen left to right. Sampling time, in 1-2-5 steps

Fields in the Output Area

Fields and their functions in the Output Area





Field	Name	Function
G	Squ/Sin/Tri/Saw	Output Waveform: Square/Sine/Triangle/Sawtooth
H	Frequency	Square wave: 10Hz—8MHz; Sin/Tri/Saw waves: 10Hz—20KHz <1MHz, in 1-2-5 steps; >1MHz, in 2-4-6-8 steps
I	DUT 50%—90%	Duty cycle

Navigate  only moves the selected menu between B and G. To move to Menus H and I, first





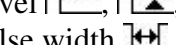
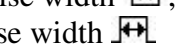
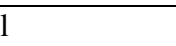
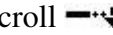
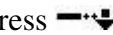
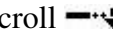

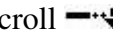
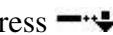
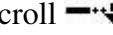
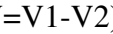
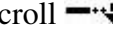
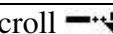
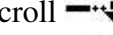
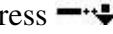
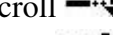
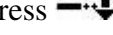
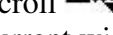
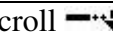
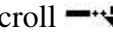
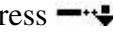

move to Menu G and then press the Select switch  to navigate among the G-I Menus.

Fields in the Measurement Area

Fields and their functions in the Measurement Area:

Field	Name	Function	Operating Instruction
J	Trigger	Trigger mode: Falling edge  , Rising edge  , Pulse and level  , Negative pulse width  , Positive pulse width 	Scroll  to choose trigger mode. Press  to choose channel (different colors).
K	THR	Trigger level	Scroll  to adjust trigger level U position shows trigger level. Press  to choose channel (CH_A/CH_B/CH_C/CH_D).
L	V1	Cursor V1: top limit of visible trigger level	Scroll  to select top limit of trigger level. Press  to choose channel (CH_A/CH_B/CH_C/CH_D).
M	V2	Cursor V2: bottom limit of visible trigger level	Scroll  to adjust bottom limit of trigger level (in X position shows V=V1-V2). Press  to choose channel (CH_A/CH_B/CH_C/CH_D).
N	T1	Time Marker T1	Scroll  to adjust time marker T1. Press  to hide time marker T1.
O	T2	Time Marker T2	Scroll  to adjust time marker T2 (in W position shows time marker T2). Press  to hide time marker T2.
P	Y	Horizontal Level of each channel	Scroll  to adjust horizontal level. Press  to choose channel (CH_A/CH_B/CH_C/CH_D).
Q	X	Choose the window to display waveforms	Scroll  to choose waveforms of different positions to display in current window.
R	T0	Select a frame in buffer to display	Scroll  to choose a frame.
S	4K	Memory depth	Scroll  to choose memory depth from 360 to 4K bytes.
T	EXT	Exit Measurement Area	Press  to exit Measurement Area.

There are 8 triggering modes in Field J:

Mode	Triggering Conditions
	Falling edge
	Rising edge
	Voltage higher than threshold
	Voltage lower than threshold
	Low level pulse width shorter than ΔT
	Low level pulse width longer than ΔT
	High level pulse width shorter than ΔT
	High level pulse width longer than ΔT

Parameter Menu

The following figure below shows a typical signal trace. Insert one probe into the WAVE OUT

socket, and another one into the CH_B socket. Make sure that the probe switches are set to 1X. Scroll Navigate $\leftarrow \downarrow \rightarrow$ to Menu G. Scroll $\leftarrow \downarrow \rightarrow$ to select a square wave output. Press $\leftarrow \downarrow \rightarrow$ to navigate to Menus H and I, and scroll $\leftarrow \downarrow \rightarrow$ to select 1KHz frequency, and 50% duty cycle.

Now, press \bullet button shortly to display current parameter list, as shown in this figure:

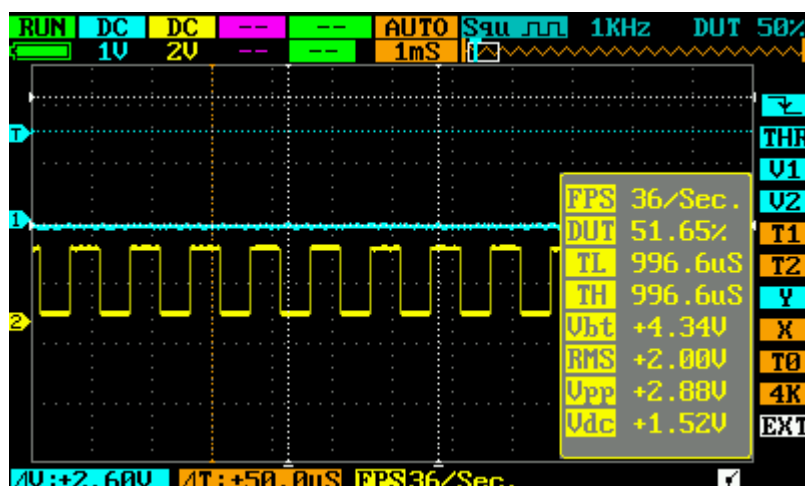

The Parameter List contains the following items and their current values:

Parameter	Function
FPS	Frames per second
DUT	Duty cycle
TL	Single cycle Low Level Time
TH	Single cycle High Level Time
Vbt	Battery voltage
RMS	Root-Mean-Square average of voltage
Vpp	Peak-to-Peak voltage
Vdc	Direct Current voltage
Max	Maximum voltage
Min	Minimum voltage
FRQ	Signal frequency
CIR	Signal cycle
EXT	Exit Parameter List

There are 12 parameters. Only 9 parameters can be displayed at a time. Short press \bullet button shows only the current 9 parameters. To see other parameters, hold down \bullet for 2 seconds and a narrower parameter list appears. Scroll $\leftarrow \downarrow \rightarrow$ to select a parameter you no longer need, and then press $\leftarrow \downarrow \rightarrow$ to choose a parameter you want to see. You can therefore select another set of 9 parameters to view. Make sure that EXT is selected. Scroll $\leftarrow \downarrow \rightarrow$ to EXT, and hold down $\leftarrow \downarrow \rightarrow$. The narrow parameter list will disappear. Next time you short press \bullet button, the parameter list you chose will appear.

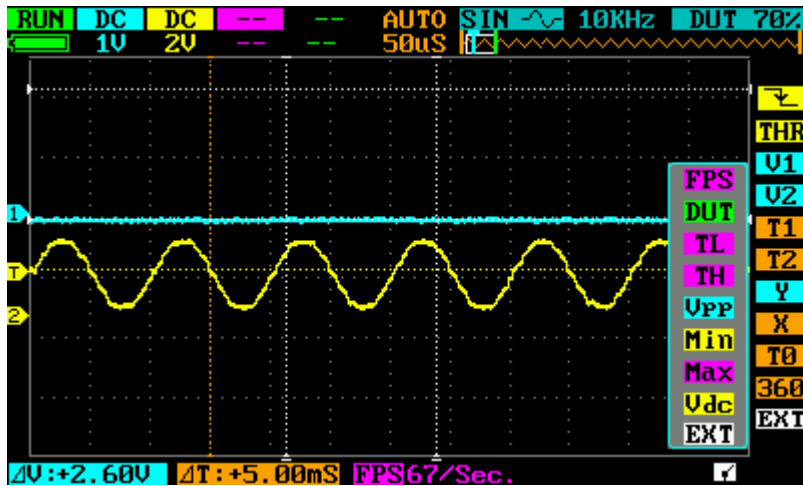

Press $\leftarrow \downarrow \rightarrow$ or choose EXT to exit.

Disk Menu

Press \blacksquare button to access the Disk Menu. Press it again to exit. Detailed functions are listed below:

Menu Item	Function	Operating Instruction
Save Param	Save current parameter settings	Press $\leftarrow \downarrow \rightarrow$ to confirm.
Save Dat	Save dat file to USB disk	Scroll $\leftarrow \downarrow \rightarrow$ to choose file. Press $\leftarrow \downarrow \rightarrow$ to confirm.
Save Buf	Save buf file (sample data in buffering area) to USB disk	Scroll $\leftarrow \downarrow \rightarrow$ to choose file. Press $\leftarrow \downarrow \rightarrow$ to confirm.
Save Bmp	Save bmp file (waveform image) to USB disk.	Scroll $\leftarrow \downarrow \rightarrow$ to choose file. Press $\leftarrow \downarrow \rightarrow$ to confirm.
Save Csv	Save csv file (export sampling data of buffering area) to USB disk	Scroll $\leftarrow \downarrow \rightarrow$ to choose file. Press $\leftarrow \downarrow \rightarrow$ to confirm.
Load Dat	Load dat file	Scroll $\leftarrow \downarrow \rightarrow$ to choose file. Press $\leftarrow \downarrow \rightarrow$ to confirm.
Load Buf	Load buf file	Scroll $\leftarrow \downarrow \rightarrow$ to choose file. Press $\leftarrow \downarrow \rightarrow$ to confirm.
BackLight	Adjust backlight brightness	Scroll $\leftarrow \downarrow \rightarrow$ to adjust backlight brightness. Press $\leftarrow \downarrow \rightarrow$ confirm.
Buzzer	Adjust buzzer volume	Scroll $\leftarrow \downarrow \rightarrow$ to adjust buzzer volume. Press $\leftarrow \downarrow \rightarrow$ to confirm.
Standby	Choose screensaver	Press $\leftarrow \downarrow \rightarrow$ to confirm.
Calibrate	Calibrate DSO203 (make sure CH_A is grounded)	Press \blacksquare to calibrate. Press $\leftarrow \downarrow \rightarrow$ to confirm

3. Examples

Example One: Measure simple signals

It is very easy to observe unknown signals in a circuit with DSO203. You can see the signal traces, and measure the frequency and peak-to-peak values of the signal.

In this simple example, following these steps:

1. Insert a probe into the WAVE OUT socket on your DSO203..
2. Insert a probe into CH_B analog input socket. Connect these two probes.
3. Set output waveform to square wave in G field, 20 KHz in Hfield, and 50% duty cycle in I field.
4. Select DC coupling for CH_B in upper C field, and select a 2V voltage level in lower C field.
5. Select AUTO display mode in upper F field, adjust the sampling time to 20uS in lower F field. Make sure that the signal trace is displayed clearly.
6. Select a proper trigger mode in J field. Here, $\overline{\text{LF}}$. Make sure the cursor is yellow.
7. Adjust trigger level THR in K field to display a stable trace. THR must be yellow also.
8. Press Parameter \bullet button to see a parameter list. Observe signal parameters, e.g.:Vpp (peak-to-peak voltage), RMS (average value of voltage), FRQ (frequency) and so forth.

You should see the following screen display:

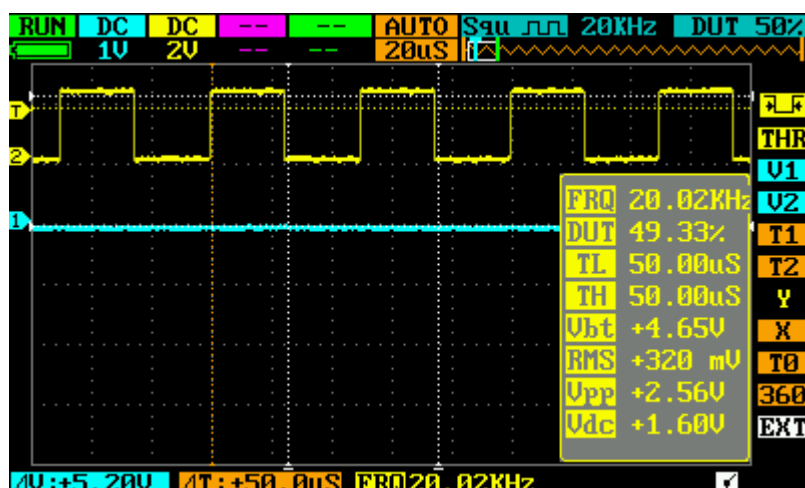

Example Two: Acquire a Single Trace

It's the most important feature of a digital storage oscilloscope to acquire non-periodic signals like pulses and spikes. To acquire a single signal trace, you need a priori knowledge of it to set the proper trigger level and trigger edge. For example, if the pulse is a TTL logic signal, trigger level should be set as 2V, trigger edge as rising edge. If the signal is not stable, you should observe it in a AUTO display mode to find the proper trigger level and trigger edge.

Operation procedure is as following:

1. Connect a probe from CH_B to a test point in your circuit.
2. Select single trace display mode, SINGL (F upper).
3. Select DC coupling for CH_B (C upper).
4. Select rising edge trigger $\overline{\text{LF}}$ (J).
5. Adjust horizontal time level (F lower) and voltage scale (C lower) to proper ranges.
6. Adjust trigger level in THR (K).
7. Press ▶|| , and wait for properly trigger signal to appear. If a signal reaches preset trigger level, a

signal trace will be displayed.

This procedure can catch occasional events very easily, such as a sudden spike of high amplitude. Set the trigger level a little bit higher than normal signal level, press **▶||**, and wait for the spike. DSO203 will automatically trigger and store the waveforms before and after the triggering event. It's shown in the figure below. You can observe the waveforms before and after the triggering event.

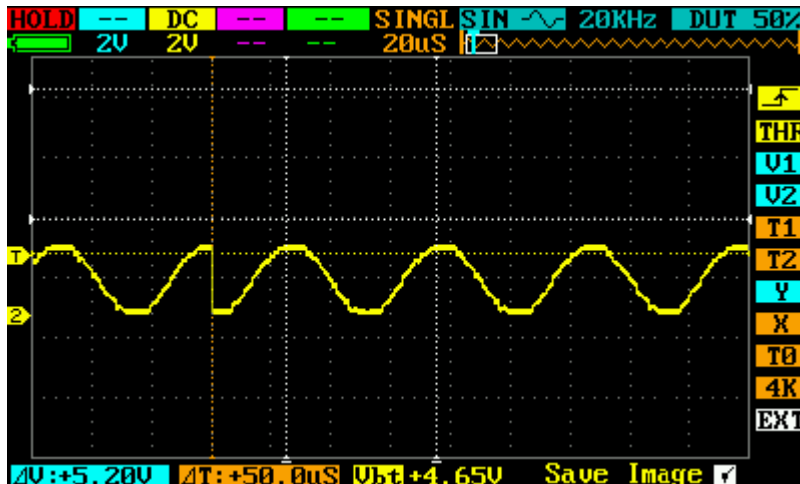

Example Three: Measurements with Cursors

There are several measuring cursors in DSO203. They are displayed as narrow dotted horizontal and vertical lines across the display screen. They are used to measure the time and voltage in the signal traces.

The following figure shows a typical analog signal trace. You can do two exercises with this trace.

Measure the cycle time of the 3rd waveform from the signal trace.

Follow these steps:

1. Navigate to T1 in N field. Change its color to yellow.
2. Scroll **←↓→+**, move cursor T1 to the 3rd peak of the trace.
3. Navigate to T2 in O field. Change its color to yellow.
4. Scroll **←↓→+**, move cursor T2 to the 4th peak of the trace.
5. Read $\Delta T=14.0uS$, in the W field of the Parameter Area.

Measure the peak-to-peak voltage of the signal trace.

Follow these steps:

1. Navigate to V1 in L field. Change its color to yellow.
2. Scroll **←↓→+**, move cursor V1 to the top of the trace.
3. Navigate to V2 in O field. Change its color to yellow.
4. Scroll **←↓→+**, move cursor V2 to the bottom of the trace.
5. Read $\Delta V=168mV$ in the X field of the Parameter Area.

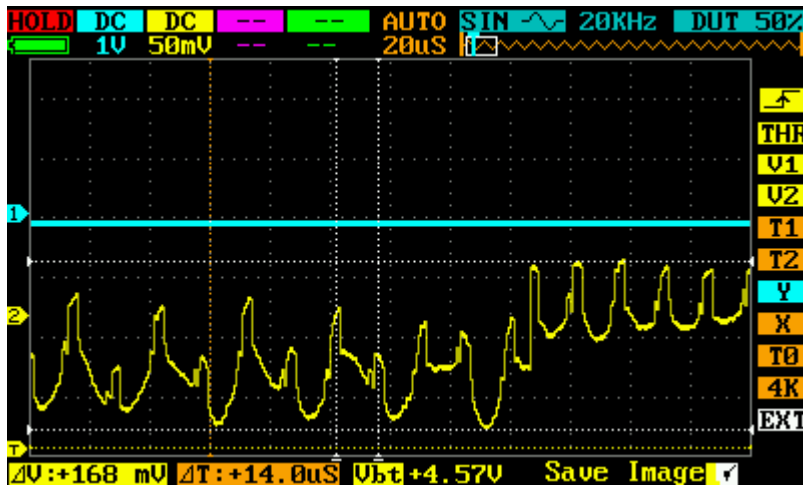

Example Four: Comparison of Waveforms

REC_A/ REC_B/ REC_C/ REC_D function in E field can be used to compare a standard signal with an unknown signal.

Follow these steps:

1. Input a standard signal to CH_A. Press **■**, and choose Save Dat 01 to save waveform, as shown in Figure 4.1:
2. Input an unknown signal to CH_A. In E field choose REC_A. Press **■**, and choose Load Dat, as shown in Figure 4.2:
3. Navigate to Y in P field. Adjust horizontal level, to compare waveforms, as shown in Figure 4.3:

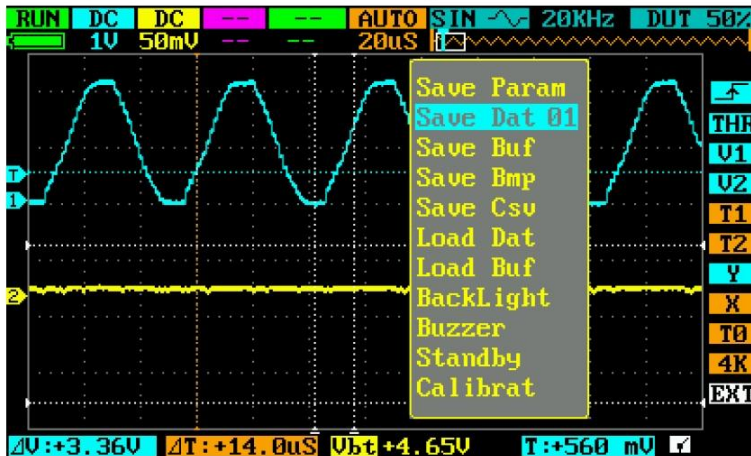

Figure 4.1

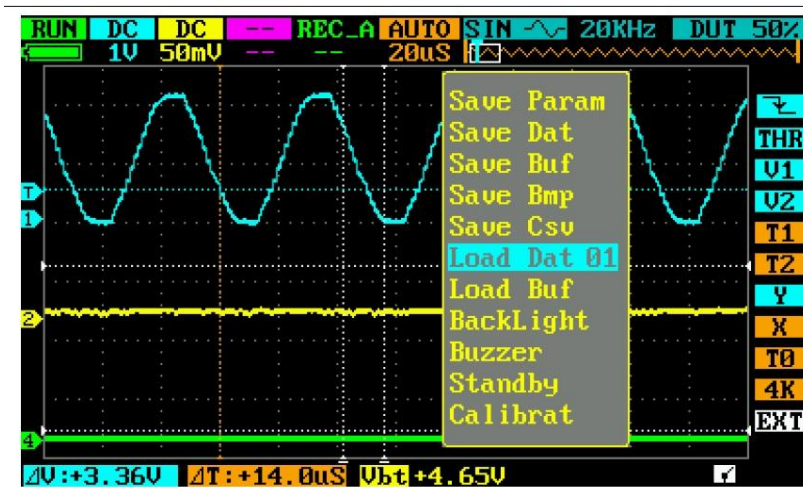

Figure 4.2

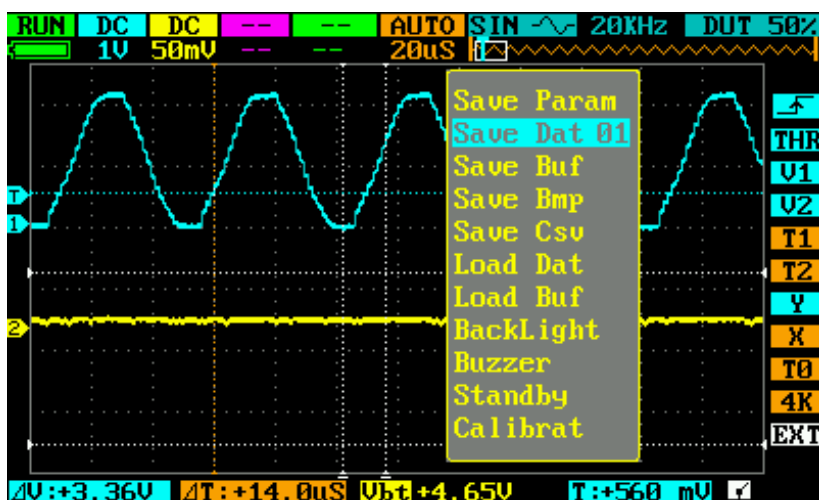

Figure 4.3

Example Five: Save waveform images

Sometimes waveform images need to be archived and analyzed on PC platform.

Follow these steps:

1. Acquire a signal trace.
2. Press **■**, and choose Save Bmp 01.
3. Scroll **←↓↑+** to choose the correct file number, and then press **←↓↑+** to confirm.

The file (named IMAG001.BMP) will be saved to built-in USB disk; as shown in following figure. To analyze waveform, copy the image file to your PC.

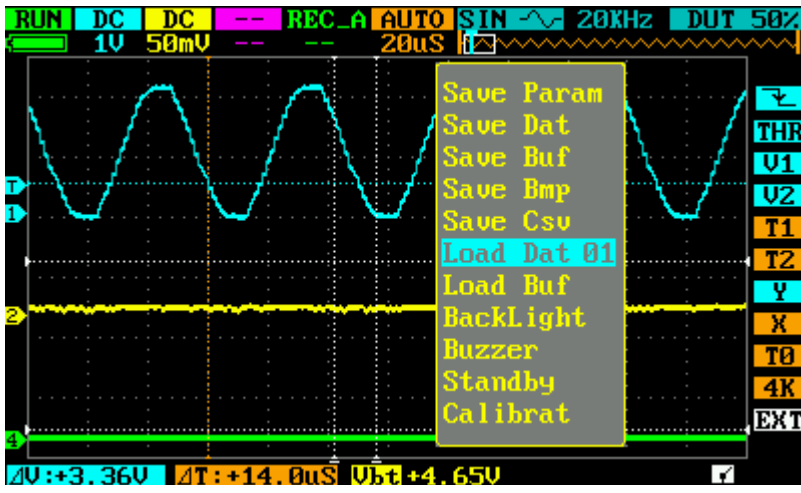

4. Operation Tips

1. To increase scan speed when measuring high frequency signals, lower buffer depth in S field. A single frame of trace has 360 points. Adjust the X value in Q field to observe the buffered waveforms in the memory.
2. After connecting an input signal, choose AC coupling in the input field to observe noise and ripple in the waveform.
3. Use cursor V1 and V2 to measure voltage difference.
4. Use cursor T1 and T2 to measure time difference.

Editor's Notes

When the new millennial was upon us, people in the Silicon Valley Forth Interest Group looked at the possibilities of producing a low cost, high performance digital storage oscilloscope. A project was started to build a prototype, but failed miserably. Before 2010, we did not have low power, high speed ADC to push the sampling rate about 1 MHz. We didn't have low-cost good color LCD's for displaying waveforms. Microcontrollers didn't have enough RAM and ROM to support large application programs.

Then Seeed Studio brought out the DSO Nano Oscilloscope. Still a bit slow, but quite usable. DSO is just getting better all the time, and now we have DSO203, sampling at 72 MHz. It is the pocket oscilloscope we dreamed about 10 years ago. It is reality.

Thanks to those hard working souls in China to bring us this marvelous instrument. The complaints I heard was mostly about the user manual. It's very small characters are hard to read. It's Chinglish is difficult to understand. So, I took it on myself to edit the text to make it easier to read. However, I had the fame of writing in Tenglish, and the manual still have rooms for improvements. Your critiques, comments, and suggestions are welcome.

Dr. Chen-Hanson Ting
156 14th Avenue
San Mateo, CA 94402 USA
002-1-650-571-7639
ting@offete.com.