



Chipsmall Limited consists of a professional team with an average of over 10 year of expertise in the distribution of electronic components. Based in Hongkong, we have already established firm and mutual-benefit business relationships with customers from,Europe,America and south Asia,supplying obsolete and hard-to-find components to meet their specific needs.

With the principle of “Quality Parts,Customers Priority,Honest Operation,and Considerate Service”,our business mainly focus on the distribution of electronic components. Line cards we deal with include Microchip,ALPS,ROHM,Xilinx,Pulse,ON,Everlight and Freescale. Main products comprise IC,Modules,Potentiometer,IC Socket,Relay,Connector.Our parts cover such applications as commercial,industrial, and automotives areas.

We are looking forward to setting up business relationship with you and hope to provide you with the best service and solution. Let us make a better world for our industry!



## Contact us

Tel: +86-755-8981 8866 Fax: +86-755-8427 6832

Email & Skype: info@chipsmall.com Web: www.chipsmall.com

Address: A1208, Overseas Decoration Building, #122 Zhenhua RD., Futian, Shenzhen, China



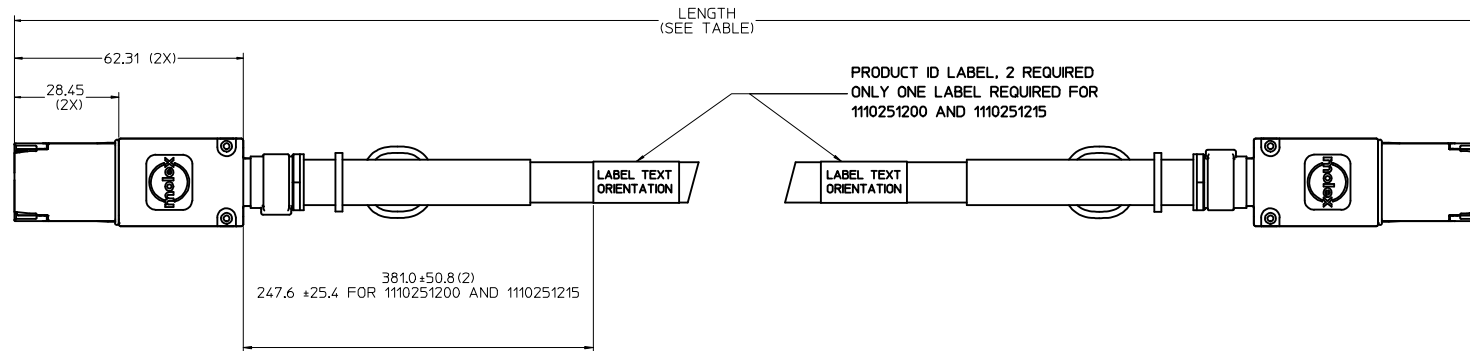
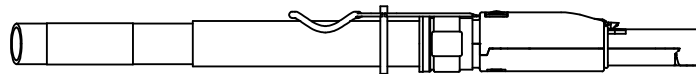
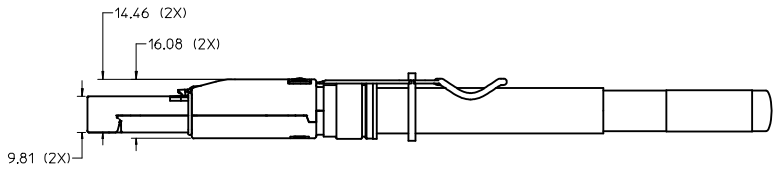
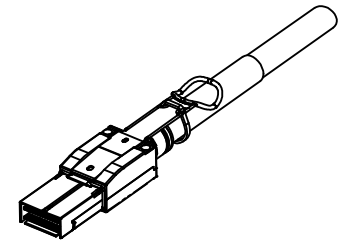
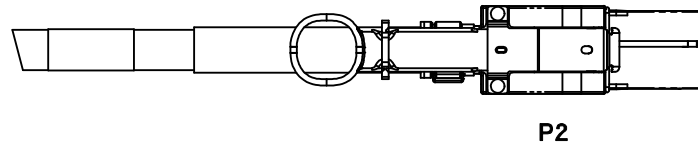
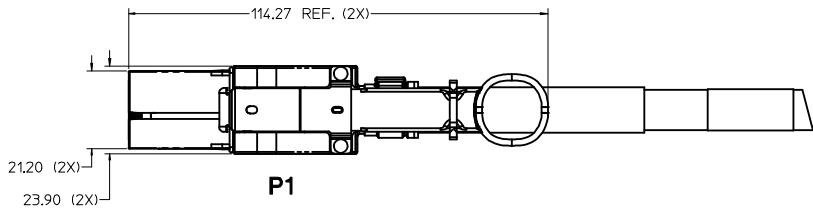

MOLEX P/N	LENGTH (M)	LENGTH TOL (mm)	AWG
1110251200	0.5M	±0.05M	30
1110251201	1.0M	±0.05M	30
1110251202	2.0M	±0.05M	30
1110251203	3.0M	±0.05M	28
1110251204	4.0M	±0.05M	26
1110251205	5.0M	±0.08M*	26
1110251206	6.0M	±0.08M*	26
1110251207	7.0M	±0.10M*	26
1110251208	8.0M	±0.10M*	26
1110251209	9.0M	±0.10M*	26
1110251210	10.0M	±0.15M*	26
1110251213	1.2M	±0.05M	30
1110251214	1.5M	±0.05M	30
1110251215	0.6M	±0.05M	30
1110251230	3.5M	±0.05M	26

\* THIS LENGTH WILL NOT MEET THE IBTA SPECIFICATION FOR INSERTION LOSS.

NOTES:

- MATERIALS  
HOUSINGS: ZINC DIE CAST  
CONTACTS: Au FLASH OVER Ni PLATING  
PULL: NYLON
- CHARACTERISTIC DIFFERENTIAL IMPEDANCE: 100 OHMS
- CABLE ASSEMBLIES MEET UL94-V0 PER FILE E72548 VOL. 1
- CABLE JACKETS ARE CL2 RATED
- ASSEMBLIES COMPLY WITH IBTA CXP INTERFACE SPECIFICATION EXCEPT AS NOTED.
- MATING CONNECTOR: 76105-0584
- ROHS COMPLIANT, NO EXEMPTIONS.

SEE REVISION TABLE IEC NO: CPG2015-0399 DRAWN BY: CHYKORAGTEL CHECKED BY: APPR:ARABURN DATE: 2014/07/15 DATE: 2014/08/04	QUALITY SYMBOLS	GENERAL TOLERANCES (UNLESS SPECIFIED)	DIMENSION STYLE	SCALE	DESIGN UNITS	THIRD ANGLE PROJECTION	
	▽=0	mm INCH	MM ONLY	1.5:1	METRIC	☉	
	▽=0	4 PLACES ±--- ±--- 3 PLACES ±--- ±--- 2 PLACES ±0.13 ±--- 1 PLACE ±0.25 ±--- 0 PLACE ±--- ±---	DRAWN BY: KWEBER CHECKED BY: DDOYE APPROVED BY: DDOYE DATE: 2008/05/20 DATE: 2008/05/20 DATE: 2010/10/26	TITLE	84CKT PASSIVE CABLE ASSEMBLY QDR INFINIBAND		
	▽=0	ANGULAR ±1/2° DRAFT WHERE APPLICABLE MUST REMAIN WITHIN DIMENSIONS	MATERIAL NO. SEE P/N TABLE SIZE D	DOCUMENT NO. SD-111025-120	SHEET NO. 1 OF 3		

THIS DRAWING CONTAINS INFORMATION THAT IS PROPRIETARY TO MOLEX INCORPORATED AND SHOULD NOT BE USED WITHOUT WRITTEN PERMISSION

WIRING CHART

P1				P2				P1				P2			
PIN	F	SIGNAL	TYPE	PIN	F	SIGNAL		PIN	F	SIGNAL	TYPE	PIN	F	SIGNAL	
A1	L	GND	C   C	C1	L	GND		C1	L	GND	C   C	A1	L	GND	
A2	S	Tx1p	----->	C2	S	Rx1p		C2	S	Rx1p	<-----	A2	S	Tx1p	
A3	S	Tx1n	----->	C3	S	Rx1n		C3	S	Rx1n	<-----	A3	S	Tx1n	
A4	L	GND	C   C	C4	L	GND		C4	L	GND	C   C	A4	L	GND	
A5	S	Tx3p	----->	C5	S	Rx3p		C5	S	Rx3p	<-----	A5	S	Tx3p	
A6	S	Tx3n	----->	C6	S	Rx3n		C6	S	Rx3n	<-----	A6	S	Tx3n	
A7	L	GND	C   C	C7	L	GND		C7	L	GND	C   C	A7	L	GND	
A8	S	Tx5p	----->	C8	S	Rx5p		C8	S	Rx5p	<-----	A8	S	Tx5p	
A9	S	Tx5n	----->	C9	S	Rx5n		C9	S	Rx5n	<-----	A9	S	Tx5n	
A10	L	GND	C   C	C10	L	GND		C10	L	GND	C   C	A10	L	GND	
A11	S	Tx7p	----->	C11	S	Rx7p		C11	S	Rx7p	<-----	A11	S	Tx7p	
A12	S	Tx7n	----->	C12	S	Rx7n		C12	S	Rx7n	<-----	A12	S	Tx7n	
A13	L	GND	C   C	C13	L	GND		C13	L	GND	C   C	A13	L	GND	
A14	S	Tx9p	----->	C14	S	Rx9p		C14	S	Rx9p	<-----	A14	S	Tx9p	
A15	S	Tx9n	----->	C15	S	Rx9n		C15	S	Rx9n	<-----	A15	S	Tx9n	
A16	L	GND	C   C	C16	L	GND		C16	L	GND	C   C	A16	L	GND	
A17	S	Tx11p	----->	C17	S	Rx11p		C17	S	Rx11p	<-----	A17	S	Tx11p	
A18	S	Tx11n	----->	C18	S	Rx11n		C18	S	Rx11n	<-----	A18	S	Tx11n	
A19	L	GND	C   C	C19	L	GND		C19	L	GND	C   C	A19	L	GND	
A20	S	SCL	█ █ █ █	C20	S	PRSNT		C20	S	PRSNT	█ █ █ █	A20	S	SCL	
A21	S	SDA	█ █ █ █	C21	S	Int_L/Reset_L		C21	S	Int_L/Reset_L	█ █ █ █	A21	S	SDA	
B1	L	GND	C   C	D1	L	GND		D1	L	GND	C   C	B1	L	GND	
B2	S	Tx0p	----->	D2	S	Rx0p		D2	S	Rx0p	<-----	B2	S	Tx0p	
B3	S	Tx0n	----->	D3	S	Rx0n		D3	S	Rx0n	<-----	B3	S	Tx0n	
B4	L	GND	C   C	D4	L	GND		D4	L	GND	C   C	B4	L	GND	
B5	S	Tx2p	----->	D5	S	Rx2p		D5	S	Rx2p	<-----	B5	S	Tx2p	
B6	S	Tx2n	----->	D6	S	Rx2n		D6	S	Rx2n	<-----	B6	S	Tx2n	
B7	L	GND	C   C	D7	L	GND		D7	L	GND	C   C	B7	L	GND	
B8	S	Tx4p	----->	D8	S	Rx4p		D8	S	Rx4p	<-----	B8	S	Tx4p	
B9	S	Tx4n	----->	D9	S	Rx4n		D9	S	Rx4n	<-----	B9	S	Tx4n	
B10	L	GND	C   C	D10	L	GND		D10	L	GND	C   C	B10	L	GND	
B11	S	Tx6p	----->	D11	S	Rx6p		D11	S	Rx6p	<-----	B11	S	Tx6p	
B12	S	Tx6n	----->	D12	S	Rx6n		D12	S	Rx6n	<-----	B12	S	Tx6n	
B13	L	GND	C   C	D13	L	GND		D13	L	GND	C   C	B13	L	GND	
B14	S	Tx8p	----->	D14	S	Rx8p		D14	S	Rx8p	<-----	B14	S	Tx8p	
B15	S	Tx8n	----->	D15	S	Rx8n		D15	S	Rx8n	<-----	B15	S	Tx8n	
B16	L	GND	C   C	D16	L	GND		D16	L	GND	C   C	B16	L	GND	
B17	S	Tx10p	----->	D17	S	Rx10p		D17	S	Rx10p	<-----	B17	S	Tx10p	
B18	S	Tx10n	----->	D18	S	Rx10n		D18	S	Rx10n	<-----	B18	S	Tx10n	
B19	L	GND	C   C	D19	L	GND		D19	L	GND	C   C	B19	L	GND	
B20	M	VCC3.3-Tx	█ █ █ █	D20	M	VCC3.3-Rx		D20	M	VCC3.3-Rx	█ █ █ █	B20	M	VCC3.3-Tx	
B21	M	VCC12-Tx	█ █ █ █	D21	M	VCC12-Rx		D21	M	VCC12-Rx	█ █ █ █	B21	M	VCC12-Tx	

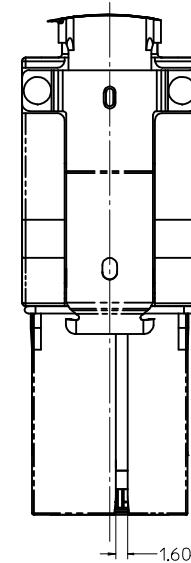

POLARIZATION FOR IBTA

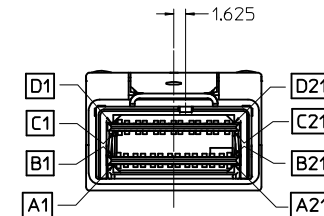

PIN LOCATIONS

FINGER CONTACT MATING (F):

- L = FIRST MATE (LONG FINGERS)
- M = SECOND MATE (MIDDLE FINGERS)
- S = LAST MATE (SHORT FINGERS)

CONNECTION TYPE:

- C = COMMON GROUND
- > = TRANSMIT TO RECEIVE ON HIGH SPEED PAIRS
- █ = CONNECTION TO A CIRCUIT ON THE PADDLE CARD

SEE REVISION TABLE IEC NO: CPG2015-0399 DRAWN BY: CHYKORAGET DATE: 2014/07/15 APPROVED BY: APPR-ARABURN DATE: 2014/08/04	QUALITY SYMBOLS	GENERAL TOLERANCES (UNLESS SPECIFIED)	DIMENSION STYLE	SCALE	DESIGN UNITS	THIRD ANGLE PROJECTION
	▽=0	mm INCH	MM ONLY	3:1	METRIC	☉
	▽=0	4 PLACES ±0.13	DRAWN BY: KWEBER	DATE: 2008/05/20	TITLE: 84CKT PASSIVE CABLE ASSEMBLY QDR INFINIBAND	
	▽=0	1 PLACE ±0.25	CHECKED BY: DDOYE	DATE: 2008/05/20	APPROVED BY: DDOYE	DATE: 2010/10/26
	ANGULAR ±1/2°	DRAFT WHERE APPLICABLE MUST REMAIN WITHIN DIMENSIONS	SEE P/N TABLE	MATERIAL NO. SD-111025-120	DOCUMENT NO.	SHEET NO. 2 OF 3
THIS DRAWING CONTAINS INFORMATION THAT IS PROPRIETARY TO MOLEX INCORPORATED AND SHOULD NOT BE USED WITHOUT WRITTEN PERMISSION						

# CABLE LABEL

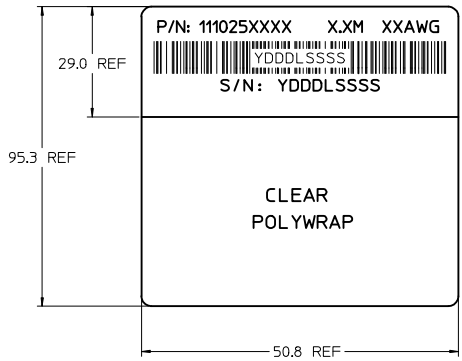

P/N: SEE P/N TABLE  
 X.XM: CABLE LENGTH (AS SHOWN FROM P/N TABLE)  
 XXAWG: CABLE GAUGE (SEE P/N TABLE)

S/N: YDDLSSSS  
 Y = YEAR, LAST DIGIT OF YEAR  
 DDD = DAY OF THE YEAR  
 L = LOCATION CODE  
 (1=USA, 2=MEXICO, 3=CHINA)  
 SSSS = SERIAL NUMBER (0001-9999)

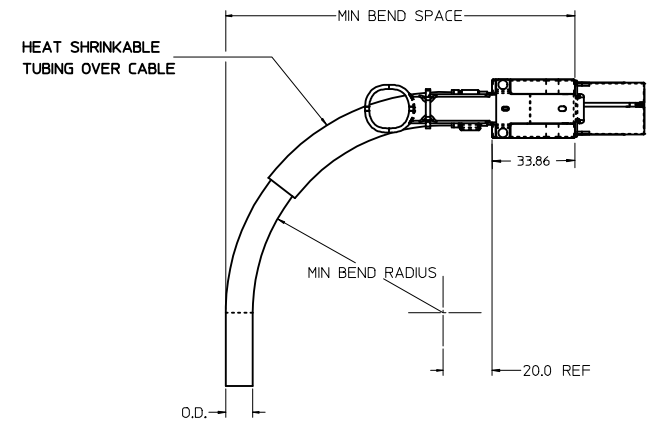

CABLE AWG	O.D.	MINIMUM BEND RADIUS (mm)	MINIMUM BEND SPACE (mm)
30	9.78	69	133
28	11.05	79	143
26	13.21	96	160

<b>SEE REVISION TABLE</b> IEC NO: CPG2015-0399 DRAWN BY: DRWNEEDINA CHECKED BY: CHYORAGYEI APPROVED BY: APPRABATURN	2013/09/18 2014/07/15 2014/08/04	QUALITY SYMBOLS ▽=0 ▽=0 ▽=0	GENERAL TOLERANCES (UNLESS SPECIFIED) mm INCH 4 PLACES ±.005 ±.0005 3 PLACES ±.01 ±.0005 2 PLACES ±.03 ±.0005 1 PLACE ±.025 ±.0005 0 PLACE ±.05 ±.0005 ANGULAR ±1/2° DRAFT WHERE APPLICABLE MUST REMAIN WITHIN DIMENSIONS	DIMENSION STYLE MM ONLY DRAWN BY: KWEBER CHECKED BY: DDOYE APPROVED BY: DDOYE DATE: 2008/05/20 DATE: 2008/05/20 DATE: 2010/10/26	SCALE 1:1 DESIGN UNITS METRIC THIRD ANGLE PROJECTION	TITLE 84CKT PASSIVE CABLE ASSEMBLY QDR INFINIBAND <b>molex</b> MATERIAL NO. SD-111025-120 DOCUMENT NO. SD-111025-120	SHEET NO. 3 OF 3
	2014/07/15 2014/08/04						
	DATE: 2010/10/26						
	DATE: 2010/10/26						

THIS DRAWING CONTAINS INFORMATION THAT IS PROPRIETARY TO MOLEX INCORPORATED AND SHOULD NOT BE USED WITHOUT WRITTEN PERMISSION