



Chipsmall Limited consists of a professional team with an average of over 10 year of expertise in the distribution of electronic components. Based in Hongkong, we have already established firm and mutual-benefit business relationships with customers from,Europe,America and south Asia,supplying obsolete and hard-to-find components to meet their specific needs.

With the principle of “Quality Parts,Customers Priority,Honest Operation,and Considerate Service”,our business mainly focus on the distribution of electronic components. Line cards we deal with include Microchip,ALPS,ROHM,Xilinx,Pulse,ON,Everlight and Freescale. Main products comprise IC,Modules,Potentiometer,IC Socket,Relay,Connector.Our parts cover such applications as commercial,industrial, and automotives areas.

We are looking forward to setting up business relationship with you and hope to provide you with the best service and solution. Let us make a better world for our industry!



Contact us

Tel: +86-755-8981 8866 Fax: +86-755-8427 6832

Email & Skype: info@chipsmall.com Web: www.chipsmall.com

Address: A1208, Overseas Decoration Building, #122 Zhenhua RD., Futian, Shenzhen, China



1 2 3 4 5 6

A

B

C

D

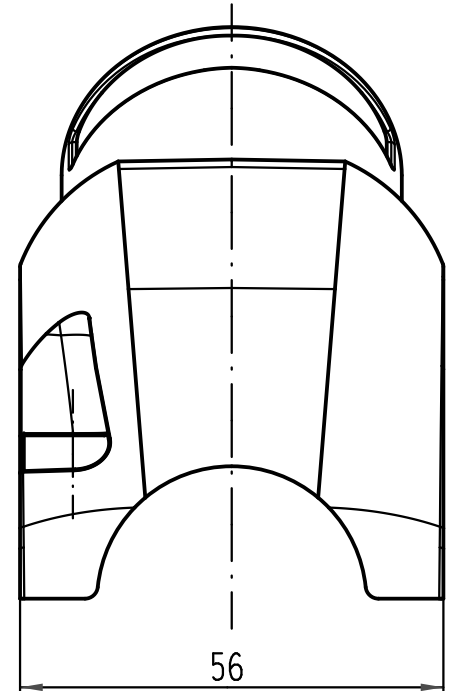
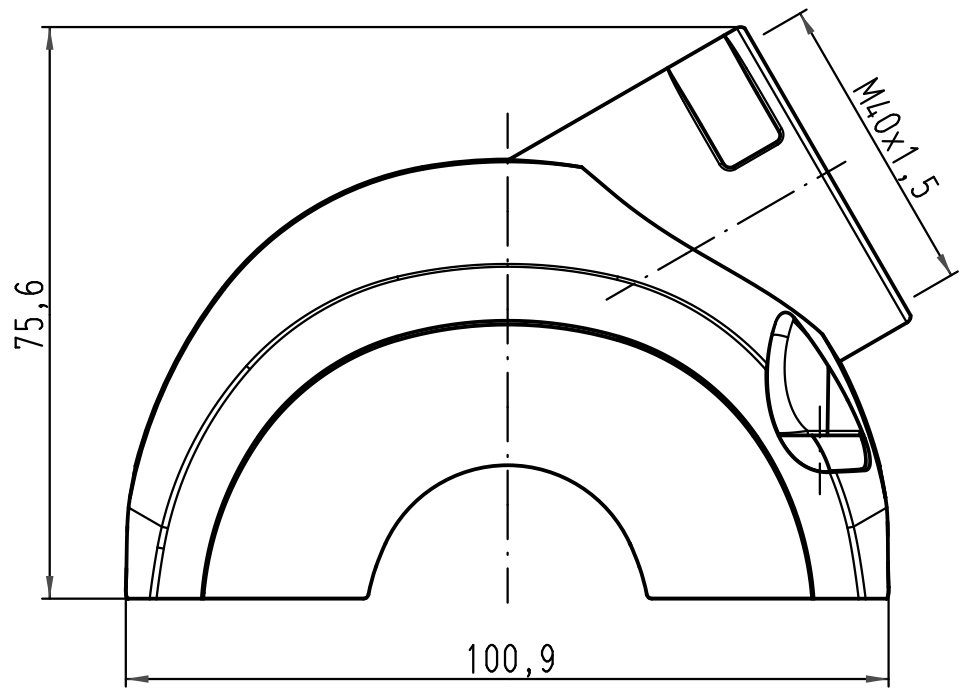

Lieferumfang: Haube mit M4 Schrauben, Scheiben und Dichtungen zur Befestigung am Trägergehäuse
 range of delivery: shell with M4 screws, washers and seals to mount on carrier hood

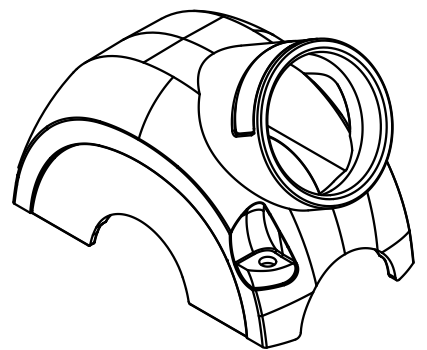

		All Dimensions in mm Original Size DIN A 4		Techn. Character.		Nicht tolerierte Maß/Free size tolerances		
				Dat.	Name	Maßstab/Scale 1:1	Han-Yellock 60- Haube-M40 seitlich shell-M40 side entry	
				Detail.	30.04.10 Ho			
				Insp.	SP			
				Stand.				
A				HARTING Electric GmbH & Co. KG D-32339 Espelkamp			TB 11 12 600 1503	
Mod.	Dat.	Name						Sub.
							Blatt/ page	