



Chipsmall Limited consists of a professional team with an average of over 10 year of expertise in the distribution of electronic components. Based in Hongkong, we have already established firm and mutual-benefit business relationships with customers from,Europe,America and south Asia,supplying obsolete and hard-to-find components to meet their specific needs.

With the principle of “Quality Parts,Customers Priority,Honest Operation,and Considerate Service”,our business mainly focus on the distribution of electronic components. Line cards we deal with include Microchip,ALPS,ROHM,Xilinx,Pulse,ON,Everlight and Freescale. Main products comprise IC,Modules,Potentiometer,IC Socket,Relay,Connector.Our parts cover such applications as commercial,industrial, and automotives areas.

We are looking forward to setting up business relationship with you and hope to provide you with the best service and solution. Let us make a better world for our industry!



## Contact us

Tel: +86-755-8981 8866 Fax: +86-755-8427 6832

Email & Skype: info@chipsmall.com Web: www.chipsmall.com

Address: A1208, Overseas Decoration Building, #122 Zhenhua RD., Futian, Shenzhen, China



MATERIAL NO.	ENGINEERING NO.	LENGTH	POLES
1206140007	LW03001K05M020	78.7 (2M)	3
1206140008	LW04001K05M020	78.7 (2M)	4

NOTICE: THIS PART IS CSA AND FACTORY MUTUAL APPROVED  
NO CHANGES CAN BE MADE TO THE ASSEMBLY, COMPONENTS  
OR SUPPLIER WITHOUT PRIOR APPROVAL FROM CSA AND  
FACTORY MUTUAL.

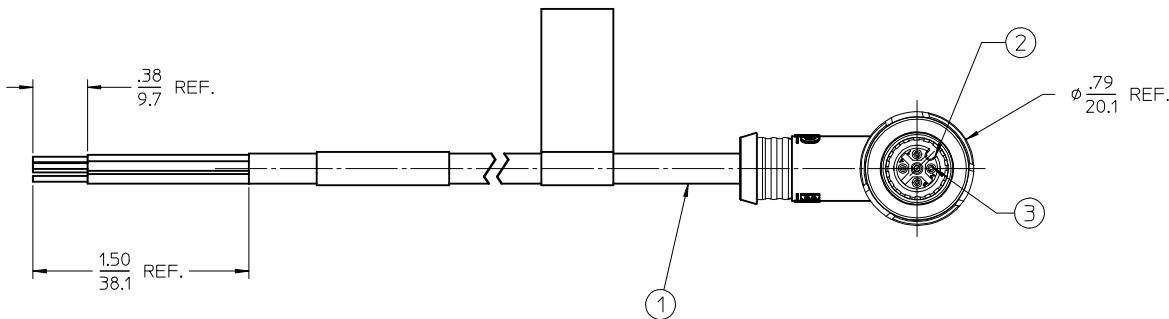
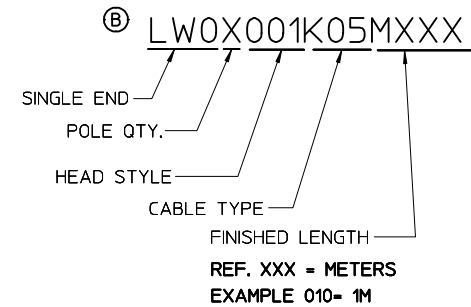
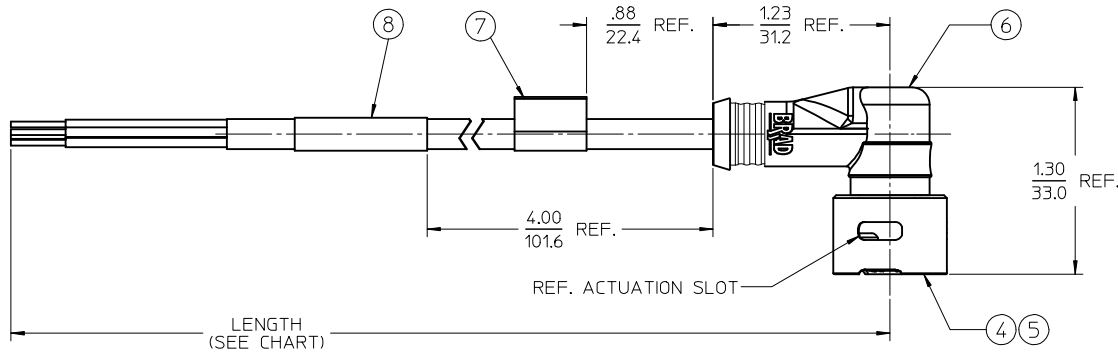
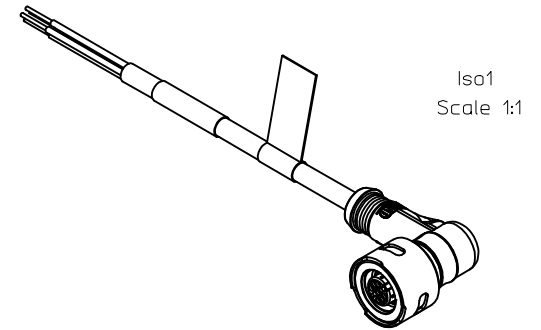

- NOTES:
1. MATERIAL: SEE TABLE
  2. FINISHES: SEE TABLE
  3. PRODUCT SPECIFICATIONS: PS-120614-001
  4. CONTROL DOC: ES-120614-001
  5. 3 & 4 POLE ELECTRICAL SPECIFICATIONS:  
VOLTAGE RATING: 125V  
CURRENT RATING: 4 AMPS
  6. 5 POLE ELECTRICAL SPECIFICATIONS:  
VOLTAGE RATING: 32V  
CURRENT RATING: 4 AMPS

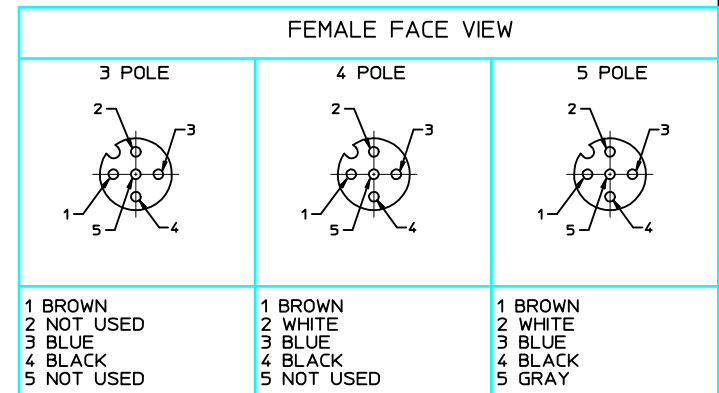

8	1	WRAP LABEL	PLASTIC FILM	BLACK/YELLOW
7	1	FLAG LABEL (WARNING)	POLYESTER	BLACK/ORANGE
6	1	OVERMOLD	TPE	YELLOW
5	1	OUTER SLEEVE	ST. STEEL	PASSIVATED
4	1	INNER SLEEVE	ST. STEEL	PASSIVATED
3	XX	CONTACT	Cu ALLOY	GOLD PLATED
2	1	INSERT	PUR	BLACK
1	1	CABLE, #22 AWG ITC/PLTC	TPE	YELLOW
ITEM	QTY.	DESCRIPTION	MATERIAL	FINISH

REV	DESCRIPTION
B	ADDED P/N LEGEND

QUALITY SYMBOLS	
▽=0	
▽=0	

GENERAL TOLERANCES (UNLESS SPECIFIED)	
4 PLACES ±	---
3 PLACES ±	---
2 PLACES ±	±.01
1 PLACE ±	±.03
ANGULAR ± 2°	

DIMENSION STYLE		SCALE	DESIGN UNITS	THIRD ANGLE PROJECTION
IN/MM		1.5:1	INCH	☉
DRAWN BY	DATE	TITLE		
RSTONE	2011/11/18	ULTRA-LOCK ZONE 2		
CHECKED BY	DATE	FEMALE 90 DEGREE		
L. HARTMANN	2012/01/27	K05, 22 AWG, TPE		
APPROVED BY	DATE	MOLEX INCORPORATED		
JFMURPHY	2012/04/18	SD-120614-008		
MATERIAL NO.	DOCUMENT NO.	SHEET NO.		
SEE CHART		1 OF 1		
THIS DRAWING CONTAINS INFORMATION THAT IS PROPRIETARY TO MOLEX INCORPORATED AND SHOULD NOT BE USED WITHOUT WRITTEN PERMISSION				

DRAWING NO.	DESCRIPTION	FINISHED GOOD REV. LEVEL
LWR000A18	MIC U-LOCK ZONE 2 RECEPT ASSY, FEM. 1/2 NPT, 22 AWG	C
LWR006A18	MIC U-LOCK ZONE 2 RECEPT ASSY, MALE 1/2 NPT, 22 AWG	B
LWRA00A18	MIC U-LOCK ZONE 2 RECEPT ASSY, FEM. 1/4 NPT, 22 AWG	C
LWRA06A18	MIC U-LOCK ZONE 2 RECEPT ASSY, MALE 1/4 NPT, 22 AWG	B
LWR000A16	MIC U-LOCK ZONE 2 RECEPT ASSY, FEM. 1/2 NPT, 18 AWG	B
LWR006A16	MIC U-LOCK ZONE 2 RECEPT ASSY, MALE 1/2 NPT, 18 AWG	B
LWXXXXXC02XXXX	U-LOCK ZONE 2 C02 CORD ASSY, 18AWG SJ00W, DC COLOR	C
LWXXXXXK03XXXX	U-LOCK ZONE 2 K03 CORD ASSY, 18AWG TPE, DC COLOR	C
LWXXXXXK05XXXX	U-LOCK ZONE 2 K05 CORD ASSY, 22AWG TPE, DC COLOR	C
SD-120614-999	CONTROL DOC FOR ULTRA-LOCK ZONE 2	D

PRELIMINARY EC NO: IPG2016-0500 DRAWN: RSTONE 2016/03/07 CHKD: WAI LEUNG 2016/05/20 APPR: JFMURPHY 2016/05/20	QUALITY SYMBOLS	GENERAL TOLERANCES (UNLESS SPECIFIED)		DIMENSION STYLE IN/MM		SCALE 1:1	DESIGN UNITS INCH	THIRD ANGLE PROJECTION	
	▽=0	4 PLACES	± ---	± ---	DRAWN BY	DATE	TITLE SCHEDULE DRAWING FOR ULTRA LOCK ZONE 2		
	∇=0	3 PLACES	± ---	± ---	CHECKED BY	DATE			
		2 PLACES	± ---	± ---	WAI LEUNG		APPROVED BY DATE JFMURPHY 2016/05/20 MATERIAL NO. - DOCUMENT NO. SD-120614-998 SHEET NO. 1 OF 1		
		1 PLACE	± ---	± ---					
	0 PLACE	± ---	± ---						
		ANGULAR ± ---°		SIZE B		THIS DRAWING CONTAINS INFORMATION THAT IS PROPRIETARY TO MOLEX INCORPORATED AND SHOULD NOT BE USED WITHOUT WRITTEN PERMISSION			
		DRAFT WHERE APPLICABLE MUST REMAIN WITHIN DIMENSIONS							

CLASS 1, DIVISION 2, GROUP A, B, C, OR D  
HAZARDOUS LOCATION

NON-HAZARDOUS LOCATION

CLASS 1, DIVISION 2, GROUP A, B, C, OR D  
HAZARDOUS LOCATION

NON-HAZARDOUS LOCATION

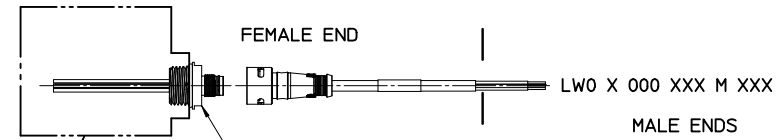

LWR X 006 A18 CXXX  
(MALE 1/2" NPT)  
LWR X A06 A18 CXXX  
(MALE 1/4" NPT)

LW0 X 000 XXX M XXX

MALE ENDS

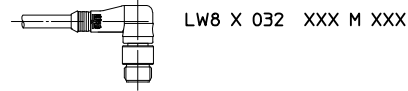

LW8 X 032 XXX M XXX

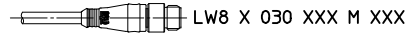

LW8 X 030 XXX M XXX

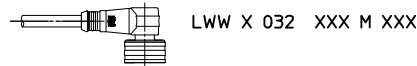

LWW X 032 XXX M XXX



LWW X 030 XXX M XXX

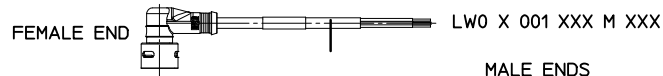

MALE ENDS

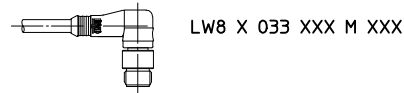

LW8 X 033 XXX M XXX

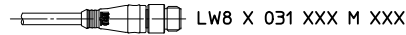

LW8 X 031 XXX M XXX

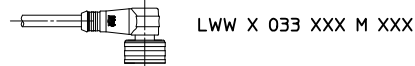

LWW X 033 XXX M XXX

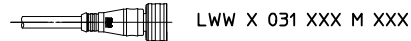

LWW X 031 XXX M XXX

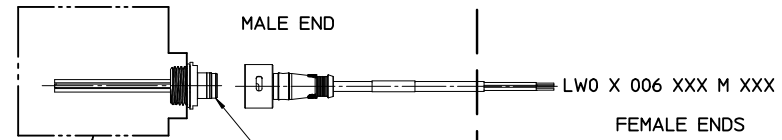

LWR X 000 A18 CXXX  
(FEMALE 1/2" NPT)  
LWR X A00 A18 CXXX  
(FEMALE 1/4" NPT)

LW0 X 006 XXX M XXX

FEMALE ENDS

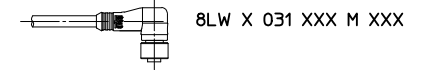

8LW X 031 XXX M XXX

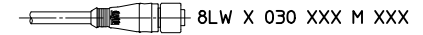

8LW X 030 XXX M XXX

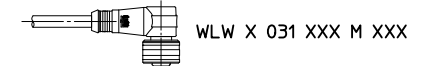

WLW X 031 XXX M XXX



WLW X 030 XXX M XXX

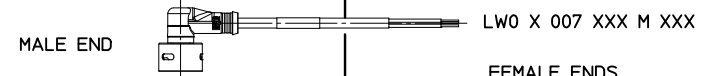

FEMALE ENDS

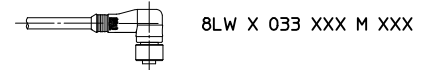

8LW X 033 XXX M XXX

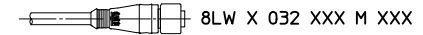

8LW X 032 XXX M XXX

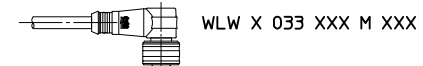

WLW X 033 XXX M XXX



WLW X 032 XXX M XXX

NOTICE: THIS PART IS CSA AND FACTORY MUTUAL APPROVED  
NO CHANGES CAN BE MADE TO THE ASSEMBLY, COMPONENTS  
OR SUPPLIER WITHOUT PRIOR APPROVAL FROM CSA AND  
FACTORY MUTUAL.

- NOTES:
1. THE INSTALLATION MUST BE IN ACCORDANCE WITH THE NATIONAL ELECTRICAL CODE (NEC), ANSI/NFPA 70. SPECIFIC REQUIREMENTS FOR THE INSTALLATION OF ITC RATED CABLE MAY BE FOUND IN ARTICLE 501.4(B)(1)(5) AND ARTICLE 727.4
  2. THE MOLDED CONSTRUCTION OF THE CORDSET AND GAS/VAPORTIGHT CONTINUOUS SHEATH OF THE CABLE MEET THE REQUIREMENTS OF THE NEC, ARTICLE 501-5(E)(2) FOR CABLE SEALS IN CLASS 1, DIVISION 2
  3. FIELD DEVICE APPROVAL FOR CLASS 1, DIV. 2 OR CLASS 1, ZONE2 INSTALLATIONS
  4. ATEX cert no: ATEX FM15ATEX0048X IECEx FMG 15.0012X

REF. SEE SHEET 3 FOR CONFIGURATION INFORMATION

THIS DRAWING SUPERSEDES ES-120614-001 REV-B

<p>ADDED NOTE 4</p> <p>EC NO: IPG2016-0500</p> <p>2015/10/16</p> <p>DRWR:RSTONE</p> <p>CHKD:WAI LEUNG</p> <p>2016/05/20</p> <p>APPR:JFMURPHY</p> <p>2016/05/20</p>	<p>DESCRIPTION</p>	<p>QUALITY SYMBOLS</p> <p> = 0</p> <p> = 0</p>	GENERAL TOLERANCES (UNLESS SPECIFIED)		DIMENSION STYLE		SCALE	DESIGN UNITS	THIRD ANGLE PROJECTION		
					IN/MM		1:1	INCH		TITLE	
					DRAWN BY DATE		CHECKED BY DATE			APPROVED BY DATE	
					RSTONE 2012/05/18		K JOZWIK 2012/05/22			JFMURPHY 2012/08/27	
		ANGULAR ±---°		MATERIAL NO.		DOCUMENT NO.		SHEET NO.			
		DRAFT WHERE APPLICABLE MUST REMAIN WITHIN DIMENSIONS		1206149999		SD-120614-999		1 OF 3			
				THIS DRAWING CONTAINS INFORMATION THAT IS PROPRIETARY TO MOLEX INCORPORATED AND SHOULD NOT BE USED WITHOUT WRITTEN PERMISSION							

CLASS 1, DIVISION 2, GROUP A, B, C, OR D  
HAZARDOUS LOCATION

HAZARDOUS LOCATION

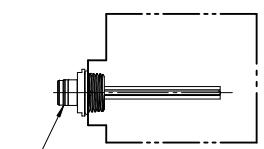
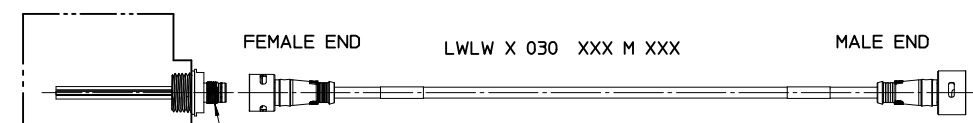

LWR X 006 A18 CXXX  
(MALE 1/2" NPT)  
LWR X A06 A18 CXXX  
(MALE 1/4" NPT)

LWR X 000 A18 CXXX  
(FEMALE 1/2" NPT)  
LWR X A00 A18 CXXX  
(FEMALE 1/4" NPT)

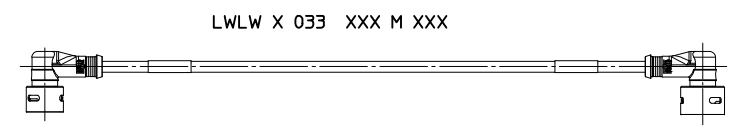
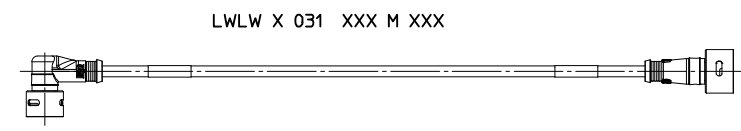
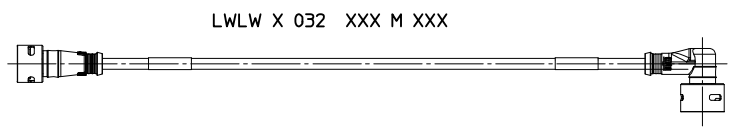

- REF:
1. SEE SHEET 1 FOR NOTES
  2. SEE SHEET 3 FOR CONFIGURATION INFORMATION

NOTICE: THIS PART IS CSA AND FACTORY MUTUAL APPROVED  
NO CHANGES CAN BE MADE TO THE ASSEMBLY, COMPONENTS  
OR SUPPLIER WITHOUT PRIOR APPROVAL FROM CSA AND  
FACTORY MUTUAL.

SEE SHEET 1 EC NO: JFG2016-0500 DRAWNRSTONE 2015/10/16 CHKD:WAI LEUNG 2016/05/20 APPR:JFMURPHY 2016/05/20	QUALITY SYMBOLS ▽=0 ▽=0	GENERAL TOLERANCES (UNLESS SPECIFIED)		DIMENSION STYLE IN/MM	SCALE 1:1	DESIGN UNITS INCH	THIRD ANGLE PROJECTION
		4 PLACES ± --- ± --- 3 PLACES ± --- ± --- 2 PLACES ± --- ± --- 1 PLACE ± --- ± ---	mm INCH ± --- ± --- ± --- ± --- ± --- ± --- ± --- ± ---	DRAWN BY RSTONE	DATE 2012/05/18	TITLE CONTROL DOC FOR ULTRA-LOCK ZONE 2	
REV D	DESCRIPTION	DRAFT WHERE APPLICABLE MUST REMAIN WITHIN DIMENSIONS		APPROVED BY JFMURPHY	DATE 2012/08/27	MOLEX INCORPORATED	
		MATERIAL NO. 1206149999	DOCUMENT NO. SD-120614-999	SHEET NO. 2 OF 3		THIS DRAWING CONTAINS INFORMATION THAT IS PROPRIETARY TO MOLEX INCORPORATED AND SHOULD NOT BE USED WITHOUT WRITTEN PERMISSION	

M12/MICROCHANGE ULTRA-LOCK CORD CONNECTORS AND CORD SETS

LWO 3 000 C02 M 020 8  
 I II III IV V VI VII

I: CONNECTOR TYPE

LWO= ULTRA-LOCK ZONE 2 MALE OR FEMALE SINGLE END CORDSET  
 LWW= ULTRA-LOCK ZONE 2 FEMALE TO STANDARD ULTRA-LOCK MALE DOUBLE ENDED CORDSET  
 WLW= ULTRA-LOCK ZONE 2 MALE TO STANDARD ULTRA-LOCK FEMALE DOUBLE ENDED CORDSET  
 LW8= ULTRA-LOCK ZONE 2 FEMALE TO STANDARD M12 MALE DOUBLE ENDED CORDSET  
 8LW= ULTRA-LOCK ZONE 2 MALE TO STANDARD M12 FEMALE DOUBLE ENDED CORDSET  
 LWLW= ULTRA-LOCK ZONE 2 FEMALE TO ULTRA-LOCK ZONE 2 MALE DOUBLE ENDED CORDSET

II: NUMBER OF POLES: 3= 3 PIN, 4= 4 PIN, 5 = 5 PIN

III: CONFIGURATION

SINGLE ENDED:  
 000= STRAIGHT FEMALE CONNECTOR  
 001= FEMALE 90°  
 006= STRAIGHT MALE, EXTERNAL THREAD  
 007= MALE 90°

DOUBLE ENDED:

030= STRAIGHT FEMALE CONNECTOR TO STRAIGHT MALE CONNECTOR  
 031= FEMALE 90° TO MALE STRAIGHT  
 032= FEMALE STRAIGHT TO MALE 90°  
 033= FEMALE 90° TO MALE 90°

IV: CABLE TYPE

C02= SJ00W YELLOW, 18 AWG, DC CODE  
 K03= PLTC/ITC, 18 AWG, TPE JACKET  
 K05= PLTC/ITC, 22 AWG, TPE JACKET

V: UNIT OF MEASURE

F= FEET  
 M= METERS

VI: CABLE LENGTH (MAY BE ANY 3 DIGIT NUMBER FROM 001-100)

1ST DIGIT= 10 X LENGTH  
 2ND DIGIT= 1 X LENGTH  
 3RD DIGIT= .1 X LENGTH

VII: COUPLING NUT MATERIAL

ULTRA-LOCK ZONE 2 END(S) ARE STAINLESS STEEL

M12 OR ULTRA-LOCK:

NONE = STANDARD MATERIAL (NICKEL PLATED BRASS)  
 8= STAINLESS STEEL

**NOTICE: THIS PART IS CSA AND FACTORY MUTUAL APPROVED  
 NO CHANGES CAN BE MADE TO THE ASSEMBLY, COMPONENTS  
 OR SUPPLIER WITHOUT PRIOR APPROVAL FROM CSA AND  
 FACTORY MUTUAL.**

M12/MICROCHANGE ULTRA-LOCK OUTLETS

LWR 3 A00 A18 M 020 8  
 I II III IV V VI VII

I: CONNECTOR TYPE

LWR= LOCKING INLETS AND OUTLETS

II: NUMBER OF POLES 3=3 PIN, 4= 4 PIN, & 5= 5 PIN

III: CONFIGURATION

SINGLE ENDED:  
 A00= FEMALE STRAIGHT (INT.THEAD) 1/4-18 NPT  
 A06= MALE STRAIGHT (EXT.THEAD) 1/4-18 NPT  
 000= FEMALE STRAIGHT (INT.THEAD) 1/2-14 NPT  
 006= MALE STRAIGHT (EXT.THEAD) 1/2-14 NPT

IV: WIRE TYPE

A18= 22 AWG, PVC, DC COLOR CODE, UL TYPE 1061  
 A16= 18 AWG, PVC, DC COLOR CODE, UL TYPE 1569  
 000= PCB PINS  
 000= PCB PINS

V: UNIT OF MEASURE

A= INCHES  
 F= FEET  
 C= CENTIMETERS  
 M= METERS

VI: WIRE LENGTH (MAY BE ANY 3 DIGIT NUMBER FROM 001-100)

1ST DIGIT= 10 X LENGTH  
 2ND DIGIT= 1 X LENGTH  
 3RD DIGIT= .1 X LENGTH

VII: SHELL MATERIAL

M12 OR ULTRA-LOCK:  
 NONE = STANDARD MATERIAL (COPPER ZINC ALLOY)  
 3= NICKEL PLATED BRASS  
 8= STAINLESS STEEL

SEE SHEET 1 EC NO: IFC2016-0500 D/DRINKSTONE 2015/10/16 CHKD:WAI LEUNG 2016/05/20 APPR: JFURPHY 2016/05/20	QUALITY SYMBOLS	GENERAL TOLERANCES (UNLESS SPECIFIED)	DIMENSION STYLE	SCALE	DESIGN UNITS	THIRD ANGLE PROJECTION
	▽=0 ▽=0	mm	IN/MM	1:1	INCH	CONTROL DOC FOR ULTRA-LOCK ZONE 2
		INCH				
	DESCRIPTION	4 PLACES ±--- ±--- 3 PLACES ±--- ±--- 2 PLACES ±--- ±--- 1 PLACE ±--- ±--- ANGULAR ±---°	DRAWN BY DATE RSTONE 2012/05/18 CHECKED BY DATE K JOZWIK 2012/05/22 APPROVED BY DATE JFMURPHY 2012/08/27	TITLE	MOLEX INCORPORATED MATERIAL NO. 1206149999 DOCUMENT NO. SD-120614-999 SHEET NO. 3 OF 3	
REV	DRAFT WHERE APPLICABLE MUST REMAIN WITHIN DIMENSIONS	THIS DRAWING CONTAINS INFORMATION THAT IS PROPRIETARY TO MOLEX INCORPORATED AND SHOULD NOT BE USED WITHOUT WRITTEN PERMISSION				