



Chipsmall Limited consists of a professional team with an average of over 10 year of expertise in the distribution of electronic components. Based in Hongkong, we have already established firm and mutual-benefit business relationships with customers from,Europe,America and south Asia,supplying obsolete and hard-to-find components to meet their specific needs.

With the principle of “Quality Parts,Customers Priority,Honest Operation,and Considerate Service”,our business mainly focus on the distribution of electronic components. Line cards we deal with include Microchip,ALPS,ROHM,Xilinx,Pulse,ON,Everlight and Freescale. Main products comprise IC,Modules,Potentiometer,IC Socket,Relay,Connector.Our parts cover such applications as commercial,industrial, and automotives areas.

We are looking forward to setting up business relationship with you and hope to provide you with the best service and solution. Let us make a better world for our industry!



Contact us

Tel: +86-755-8981 8866 Fax: +86-755-8427 6832

Email & Skype: info@chipsmall.com Web: www.chipsmall.com

Address: A1208, Overseas Decoration Building, #122 Zhenhua RD., Futian, Shenzhen, China



Printmount Switch Short Stroke 12.7 mm



See below:

[Approvals and Compliances](#)

Description

- Switches are possible with different heights
- High-quality gold and silver contacts
- Solder terminals

Unique Selling Proposition

- Reliable tactile feedback on input
- Simple assembly
- Long life time

Weblinks

[html-datasheet](#), [General Product Information](#), [CAD-Drawings](#), [Product News](#), [Detailed request for product](#)

Technical Data

Electrical Data

Contact Material Silver

Switching Voltage	max. 48 VDC
Switching Current	max. 125 mA
Rated Switching Capacity	2.4 W
Lifetime	> 1 million actuations at Rated Switching Capacity
Contact Resistance	< 50 mΩ
	< 50 mΩ after lifetime
Insulation Resistance	> 100 MΩ
Duration of Bounce	typ. 0.1 ms

Contact Material Gold

Switching Voltage	max. 24 VDC
Switching Current	max. 50 mA
Rated Switching Capacity	0.48 W
Lifetime	> 1 million actuations at Rated Switching Capacity
Contact Resistance	< 50 mΩ
	< 50 mΩ after lifetime
Insulation Resistance	> 100 MΩ
Duration of Bounce	typ. 0.1 ms

Mechanical Data

Actuating Force	2.5 ± 0.5 N
Actuating Travel	0.45 ± 0.1 mm
End Stop Strength	> 50 N
Lifetime	> 1 million actuations

Climatical Data

Operating Temperature	-25 °C to 85 °C
Storage Temperature	-25 °C to 85 °C
IP-Protection	IP 40

Other Data

Contact Material	Ag / Au
------------------	---------

Soldering Data

Solderability	235 °C / 2 sec (IEC 60068-2-20 Test Ta Method 1)
Resistance to Soldering Heat	260 °C / 5 sec (IEC 60068-2-20 Test Tb Method 1A)

Material

Sealing membrane IP 67	VMQ
Contact Material Gold	CuZn37 3µm Ni 2 µm Au
Contact Material Silver	CuZn37 2,5 µm Au passivated
Socket	Thermoplastic (PES)
Actuator	Thermoplastic (PC)

Approvals and Compliances

Detailed information on product approvals, code requirements, usage instructions and detailed test conditions can be looked up in [Details about Approvals](#)



Application standards

Application standards where the product can be used

Organization	Design	Standard	Description
	Designed for applications acc.	IEC/UL 60950	IEC 60950-1 includes the basic requirements for the safety of information technology equipment.

Compliances

The product complies with following Guide Lines

Identification	Details	Initiator	Description
	RoHS	SCHURTER AG	EU Directive RoHS 2011/65/EU
	China RoHS	SCHURTER AG	The law SJ / T 11363-2006 (China RoHS) has been in force since 1 March 2007. It is similar to the EU directive RoHS.
	REACH	SCHURTER AG	On 1 June 2007, Regulation (EC) No 1907/2006 on the Registration, Evaluation, Authorization and Restriction of Chemicals 1 (abbreviated as "REACH") entered into force.

Dimension [mm]

Short actuator

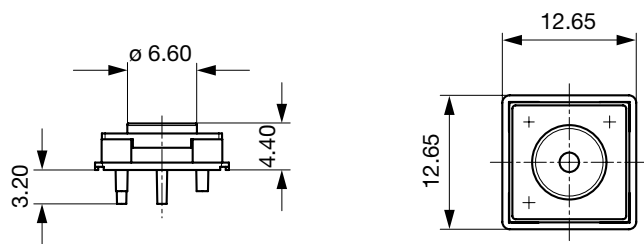

Long actuator

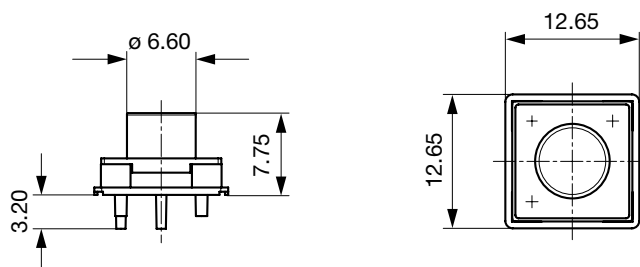

Height variable actuator

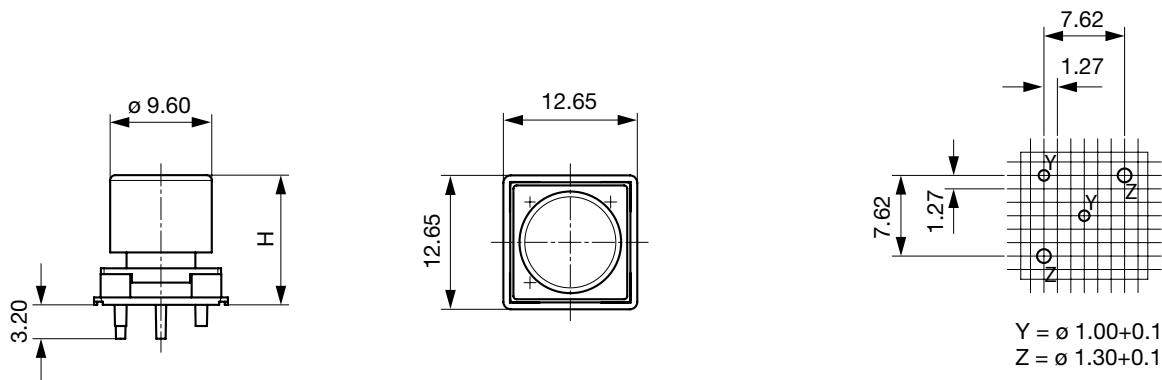

Drilling diagram

Diagrams

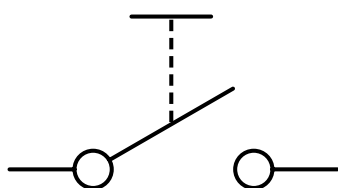

All Variants

Kontakte	Type	Overall height / Color	Overall height ¹⁾ / Color	Bestellnummer
Au	Long actuator	-	-	1241.1022
Au	Height variable	10.75 mm / blue	-	1241.1032.4
Ag	Short actuator	-	-	1241.1052
Ag	Long actuator	-	-	1241.1072
Ag	Height variable	8.50 mm / yellow	-	1241.1082.1
Ag	Height variable	-	14.50 mm / yellow + black	1241.1082.11
Ag	Height variable	9.25 mm / orange	-	1241.1082.2
Ag	Height variable	10.00 mm / red	-	1241.1082.3
Ag	Height variable	10.75 mm / blue	-	1241.1082.4
Ag	Height variable	-	16.75 mm / blue + black	1241.1082.41
Ag	Height variable	11.50 mm / green	-	1241.1082.5
Ag	Height variable	13.75 mm / white	-	1241.1082.8

¹⁾ Starting with 14.50 mm the heights are achieved with an additional (second) cap of black color

 Most Popular.

Availability for all products can be searched real-time: <https://www.schurter.com/en/Stock-Check/Stock-Check-SCHURTER>

Packaging unit 100 pcs