



Chipsmall Limited consists of a professional team with an average of over 10 year of expertise in the distribution of electronic components. Based in Hongkong, we have already established firm and mutual-benefit business relationships with customers from,Europe,America and south Asia,supplying obsolete and hard-to-find components to meet their specific needs.

With the principle of “Quality Parts,Customers Priority,Honest Operation,and Considerate Service”,our business mainly focus on the distribution of electronic components. Line cards we deal with include Microchip,ALPS,ROHM,Xilinx,Pulse,ON,Everlight and Freescale. Main products comprise IC,Modules,Potentiometer,IC Socket,Relay,Connector.Our parts cover such applications as commercial,industrial, and automotives areas.

We are looking forward to setting up business relationship with you and hope to provide you with the best service and solution. Let us make a better world for our industry!



## Contact us

Tel: +86-755-8981 8866 Fax: +86-755-8427 6832

Email & Skype: info@chipsmall.com Web: www.chipsmall.com

Address: A1208, Overseas Decoration Building, #122 Zhenhua RD., Futian, Shenzhen, China



Eveready 1250

**D**  
**SUPER HEAVY DUTY**



**Industry Standard Dimensions**

mm (inches)

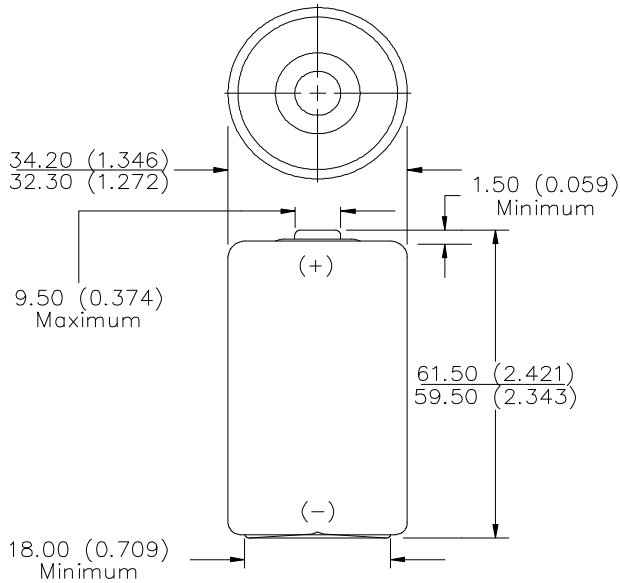

**Chemical System:** Zinc-Manganese Dioxide (Zn/MnO<sub>2</sub>)  
(No Added Mercury or Cadmium)

**Designation:** ANSI-13D, IEC-R20

**Battery Voltage:** 1.5 Volts

**Operating Temp:** -18°C to 55°C (0°F to 130°F)

**Average Weight:** 89.0 grams (3.1 oz.)

**Volume:** 53 cubic centimeters (3.2 cubic inch)

**Average Capacity:** 8,000 mAh to 0.8 volts  
(Rated at 25 mA continuous at 21°C)

**Cell:** One No. 50 (size "D")

**Jacket:** Metal

**TYPICAL PERCENT SERVICE**  
3.9 ohm - 4 hours/ day to 0.75 volts

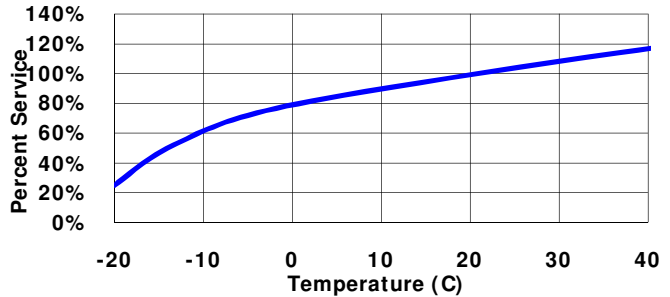

**CONSTANT RESISTANCE PERFORMANCE**  
Typical Service

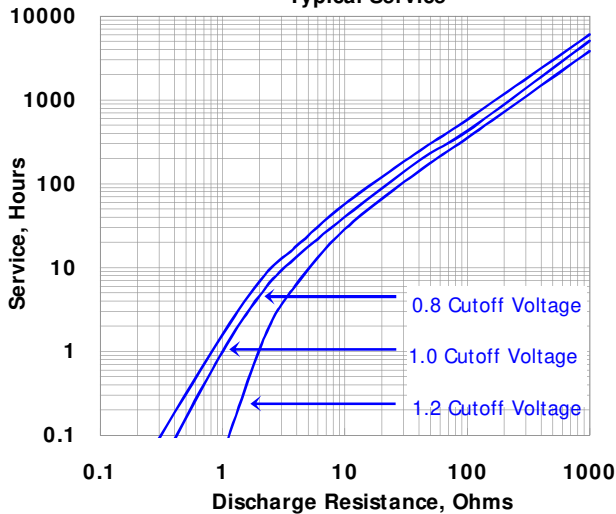

**CONSTANT CURRENT DISCHARGE**  
Typical Service

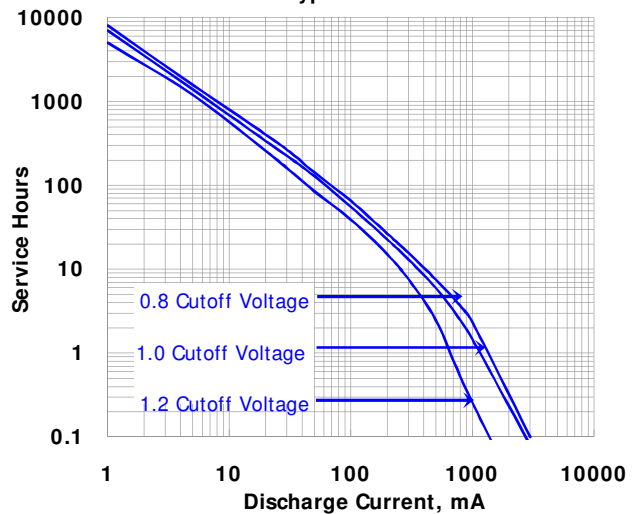

**Important Notice**

This data sheet contains information specific to batteries manufactured at the time of its publication.

**Contents herein do not constitute a warranty.**

Copyright © Eveready Battery Co. - All rights reserved

# Eveready 1250

## Industry Standard Tests (21° C)

**RADIO**  
10 ohm - 4 hours/ day

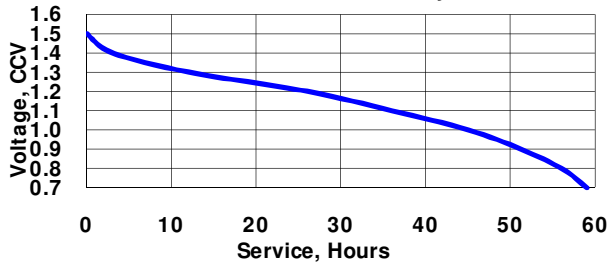

**PORTABLE STEREO**  
3.9 ohm - 1 hr/ day

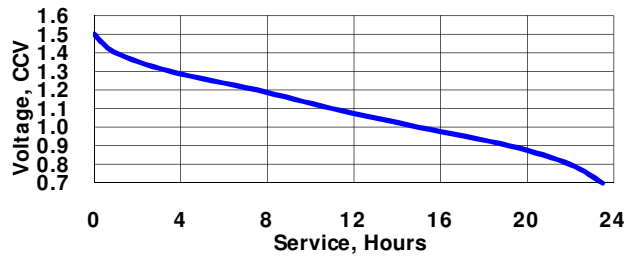

**TOY**  
2.2 ohm - 1 hr/ day

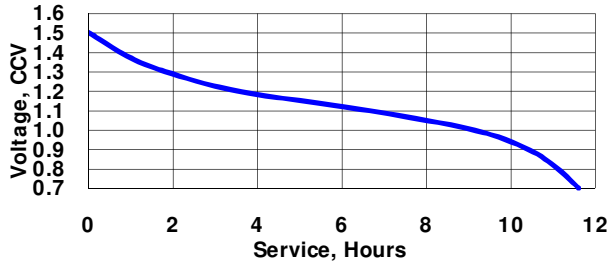

**PORTABLE LIGHT**  
2.2 ohms - 4 min/ hour 8 hours/ day

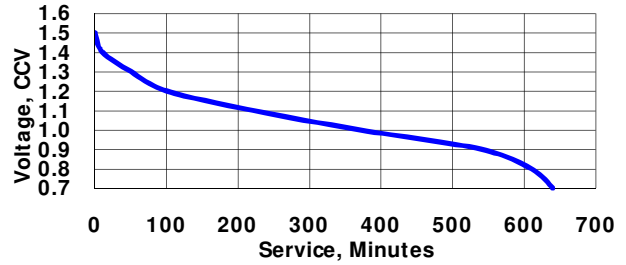

### Important Notice

This data sheet contains information specific to batteries manufactured at the time of its publication.

**Contents herein do not constitute a warranty.**

Copyright © Eveready Battery Co. - All rights reserved