



Chipsmall Limited consists of a professional team with an average of over 10 year of expertise in the distribution of electronic components. Based in Hongkong, we have already established firm and mutual-benefit business relationships with customers from,Europe,America and south Asia,supplying obsolete and hard-to-find components to meet their specific needs.

With the principle of "Quality Parts,Customers Priority,Honest Operation,and Considerate Service",our business mainly focus on the distribution of electronic components. Line cards we deal with include Microchip,ALPS,ROHM,Xilinx,Pulse,ON,Everlight and Freescale. Main products comprise IC,Modules,Potentiometer,IC Socket,Relay,Connector.Our parts cover such applications as commercial,industrial, and automotives areas.

We are looking forward to setting up business relationship with you and hope to provide you with the best service and solution. Let us make a better world for our industry!



## Contact us

Tel: +86-755-8981 8866 Fax: +86-755-8427 6832

Email & Skype: info@chipsmall.com Web: www.chipsmall.com

Address: A1208, Overseas Decoration Building, #122 Zhenhua RD., Futian, Shenzhen, China





Website: [www.displaytech.com.hk](http://www.displaytech.com.hk)

# **LCD Module**

## **Product Specification**

**Product: 128240C-RGB Series LCD Module (240 x 128 DOTS)**

## **PRODUCT SPECIFICATIONS**

- GENERAL SPECIFICATION
- ABSOLUTE MAXIMUM RATINGS
- ELECTRICAL CHARACTERISTICS
- ELECTRO-OPTICAL CHARACTERISTICS
- BLOCK DIAGRAM
- MECHANICAL DRAWING
- BACKLIGHT DRAWING
- BACKLIGHT SPECIFICATION
- QUALITY GUARANTEE
- PRECAUTIONS FOR USING LCD MODULES
- USING LCD MODULES
- REVISION RECORD

**Contents in this document are subject to change without notice. No part of this document may be reproduced or transmitted in any form or by any means, electronic or mechanical, for any purpose, without the express written permission of Displaytech Ltd.**

**2 October 2008.**

■ GENERAL SPECIFICATION

| Item                    | Contents                  |
|-------------------------|---------------------------|
| Display Format          | 240 x 128 DOTS            |
| Dot Size (W x H)        | 0.22 x 0.22               |
| View Area (W x H)       | 70.0 mm x 35.0mm          |
| Module Size (W x H x T) | 77.4 mm x 52.4mm x 9.3 mm |
| LCD Type                | FSTN                      |
| Polarizer Mode          | Transflective             |
| View Angle              | 6 / 12 O'clock            |
| Backlight               | LED                       |
| Backlight Driver Type   | External Power            |
| Backlight Color         | RGB                       |
| Controller & LCD Driver | ST7529-G                  |
| Driving Method          | 1/144 Duty, 1/12 Bias     |

■ ABSOLUTE MAXIMUM RATINGS (Ta=25°C VSS=0V)

| ITEM                             | SYMBOL   | MIN. | TYP. | MAX.    | UNIT |
|----------------------------------|----------|------|------|---------|------|
| Power Supply for Logic           | VDD-VSS  | -0.5 | ---  | 4.0     | V    |
| Power Supply for LCD             | VLCD-VSS | -0.5 | ---  | 20.0    | V    |
| Input Voltage                    | VIN      | -0.5 | ---  | VDD+0.5 | V    |
| Supply Voltage for LED Backlight | VLED     | ---  | 3.2  | ---     | V    |
| Normal Operating Temperature     | Top      | 0    | ---  | 50      | °C   |
| Normal Storage Temperature       | Tst      | -10  | ---  | 60      | °C   |
| Wide Operating Temperature       | Top      | -20  | ---  | 70      | °C   |
| Wide Storage Temperature         | Tst      | -30  | ---  | 80      | °C   |

■ ELECTRICAL CHARACTERISTICS (Ta=25°C, VDD=3.0V+/-5%)

| ITEM                       | SYMBOL  | CONDITION | MIN.   | TYP. | MAX.   | UNIT |
|----------------------------|---------|-----------|--------|------|--------|------|
| Power Supply for LCM       | VDD-VSS | ---       | 2.85   | 3.0  | 3.15   | Volt |
| Input Voltage              | VIL     | L level   | Vss    | ---  | 0.3VDD | Volt |
|                            | VIH     | H level   | 0.7VDD | ---  | VDD    | Volt |
| LCD Module Driving Voltage | VO-VSS  | ---       | ---    | ---  | ---    | Volt |
|                            |         | 25°C      | ---    | 14.5 | ---    |      |
|                            |         | ---       | ---    | ---  | ---    |      |
| Supply Current for LCM     | IDD     | VDD=3.0V  | ---    | 2.0  | ---    | mA   |
|                            | Ie      | ---       | ---    | ---  | ---    |      |
|                            | ILED    | VLED=3.2V | ---    | 80   | ---    |      |

REMARK:

- When the loading of LCD panel is heavier, the performance of booster will not be in a good working condition. The user may set the BOOSTER EFFICIENCY level to be higher and only a little bit more current needed.

**ELECTRO-OPTICAL CHARACTERISTICS**

| NO | Item                          | Symbol | Measuring Condition         | STD.Value |     |       |     | Unit | Remark         |
|----|-------------------------------|--------|-----------------------------|-----------|-----|-------|-----|------|----------------|
|    |                               |        |                             | °C        | Min | Typ   | Max |      |                |
| 1  | Recommended Operating Voltage | VLCD   | $\gamma = 0$<br>$\Phi = 0$  | 25        | 14  | 14.5  | 15  | V    | Note1<br>Note2 |
| 2  | Operating Voltage             | Vth    | $\gamma = 0$<br>$\Phi = 0$  | 0         | --- | ---   | --- |      |                |
|    |                               |        |                             | 25        | --- | 1.869 | --- |      |                |
|    |                               | Vsat   | $\gamma = 0$<br>$\Phi = 0$  | 0         | --- | ---   | --- |      |                |
|    |                               |        |                             | 25        | --- | 2.116 | --- |      |                |
| 3  | Response time                 | Tr     | $\gamma = 0$<br>$\Phi = 10$ | 0         | --- | ---   | --- |      |                |
|    |                               |        |                             | 25        | --- | 240   | --- |      |                |
|    |                               | Tf     | $\gamma = 0$<br>$\Phi = 10$ | 0         | --- | ---   | --- |      |                |
|    |                               |        |                             | 25        | --- | 200   | --- |      |                |
| 4  | Viewing Angle (Cr□2)          | -      | $\Phi = 0^\circ$            | 25        | --- | 40    | --- | Deg  | Note1          |
|    |                               | -      | $\Phi = 180^\circ$          | 25        | --- | 35    | --- |      |                |
|    |                               | -      | $\Phi = 90^\circ$           | 25        | --- | 30    | --- |      |                |
|    |                               | -      | $\Phi = 270^\circ$          | 25        | --- | 30    | --- |      |                |
| 5  | Current Consumption           | ILCD   | Hz=64                       | 25        | --- | 18    | --- | uA   | Note3          |

**NOTE 1: DEFINITION OF VIEWING ANGLE AND DIRECTION**

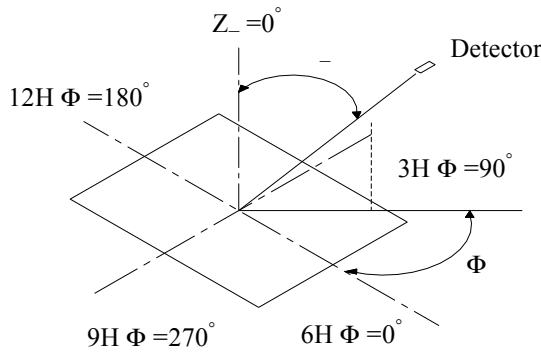

**NOTE 2: THERSHOLD VOLTAGE AND SATURATION VOLTAGE**

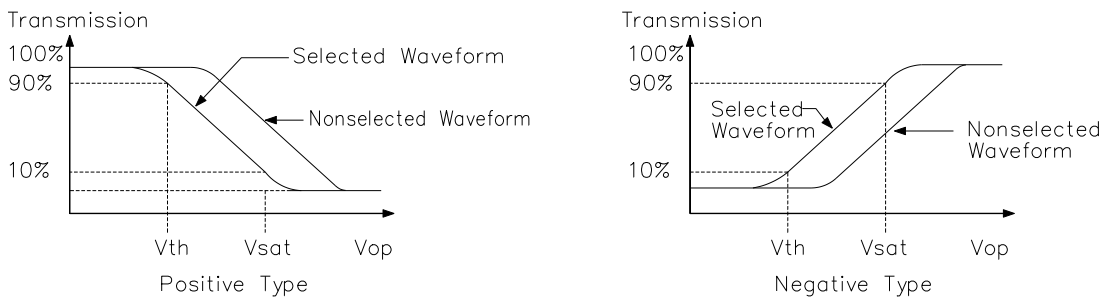

**Vth:** The voltage Vop which the transmission rate of segment is 90%(positive) or 10%(negative) of saturated value on conditions of the selected waveform. (non-selected waveform is opposition)

**Vsat:** The voltage Vop which the transmission rate of segment is 10%(positive) or 10%(negative) of saturated value on conditions of the selected waveform. (non-selected waveform is opposition)

**NOTE 3: CURRENT CONSUMPTION ( $I_{LCD}$ )**

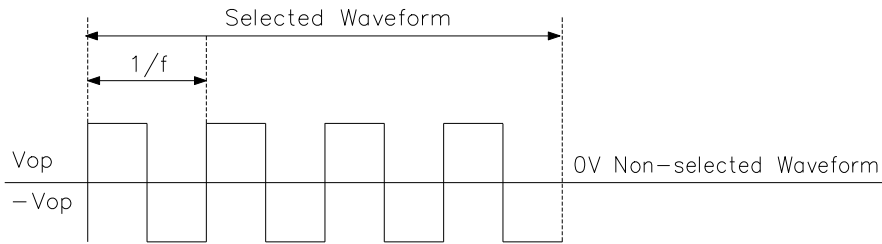

**Conditions:**

- 1. Driving waveform: static waveform.
- 2. Voltage applied to all segments

**NOTE 4: RESPONSE TIME ( $T_r$ ,  $T_f$ )**

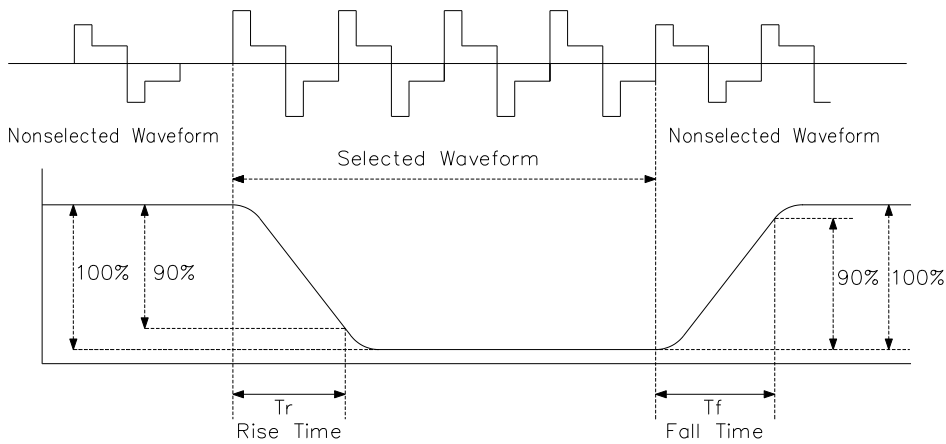

**NOTE 5: CONTRAST RATIO (CR)**

5.1 POSITIVE TYPE:

$$\text{CONTRAST RATIO} = \frac{\text{BRIGHTNESS AT VOP (NON-SELECTED)}}{\text{BRIGHTNESS AT VOP (SELECTED)}}$$

5.2 NEGATIVE TYPE:

$$\text{CONTRAST RATIO} = \frac{\text{BRIGHTNESS AT VOP (SELECTED)}}{\text{BRIGHTNESS AT VOP (NON-SELECTED)}}$$

**NOTE 6: CAPACITANCE (C)**

Measuring Methode Of Capacitance



**Conditions:**

Voltage applied to all segments.

■ BLOCK DIAGRAM

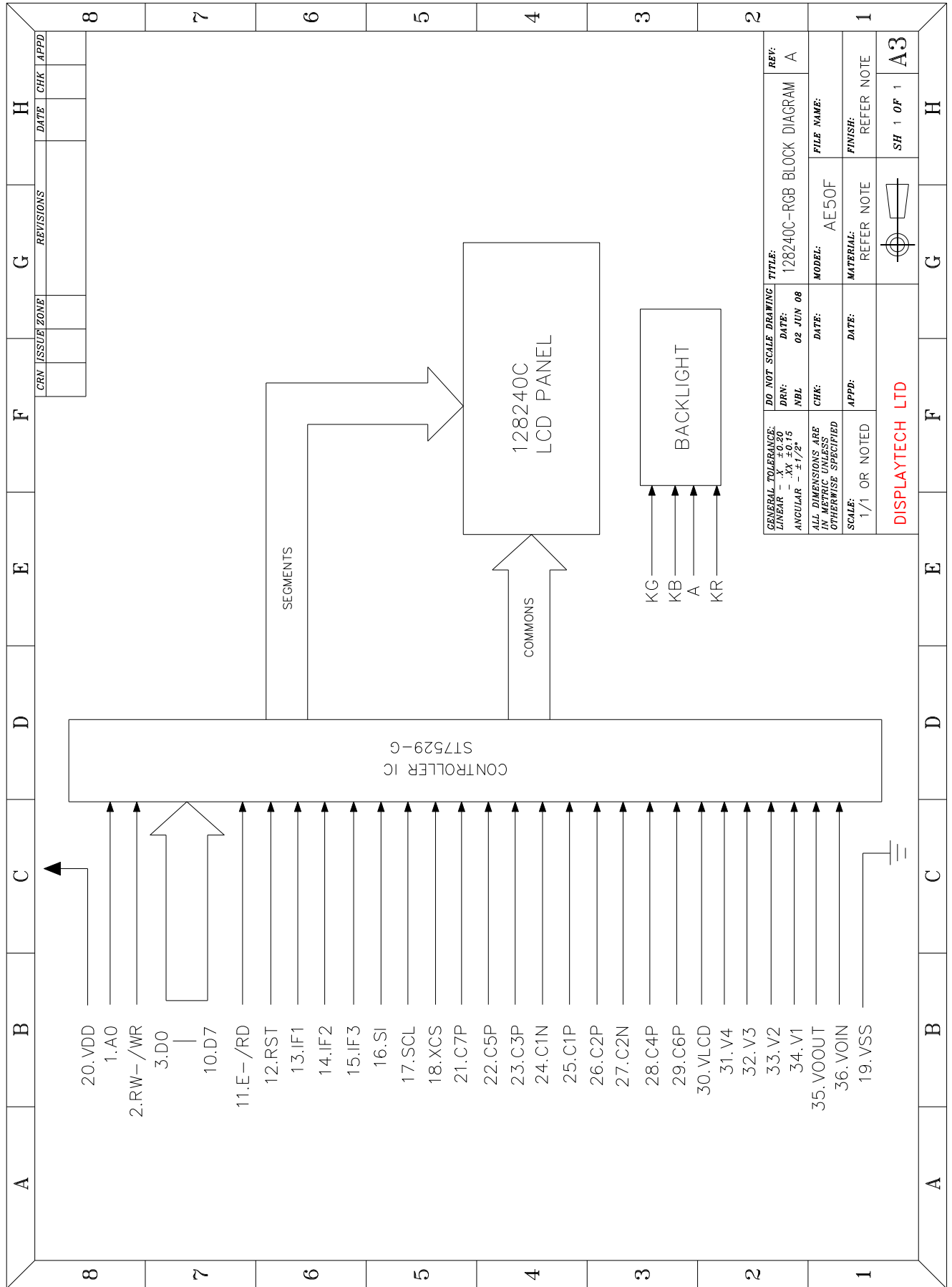

|   |  |                             |                           |  |                              |                  |  |
|---|--|-----------------------------|---------------------------|--|------------------------------|------------------|--|
| <b>GENERAL TOLERANCE:</b><br>LINEAR - $\pm 0.15$<br>ANGULAR - $\pm 1/2^\circ$ |  | <b>DO NOT SCALE DRAWING</b> |                           | <b>TITLE:</b><br>128240C-RGB BLOCK DIAGRAM |                              | <b>REV:</b><br>A |  |
| <b>ALL DIMENSIONS ARE UNLESS OTHERWISE SPECIFIED</b>                          |  | <b>DRN:</b><br>NBL          | <b>DATE:</b><br>02 JUN 08 | <b>MODEL:</b><br>AE50F                     | <b>FILE NAME:</b>            |                  |  |
| <b>SCALE:</b><br>1/1 OR NOTED   |  | <b>CHK:</b>                 | <b>DATE:</b>              | <b>MATERIAL:</b><br>REFER NOTE             | <b>FINISH:</b><br>REFER NOTE |                  |  |
| <b>DISPLAYTECH LTD</b>  |  |                             |                           |  |                              | <b>SH 1 OF 1</b> |  |

### MECHANICAL DRAWING

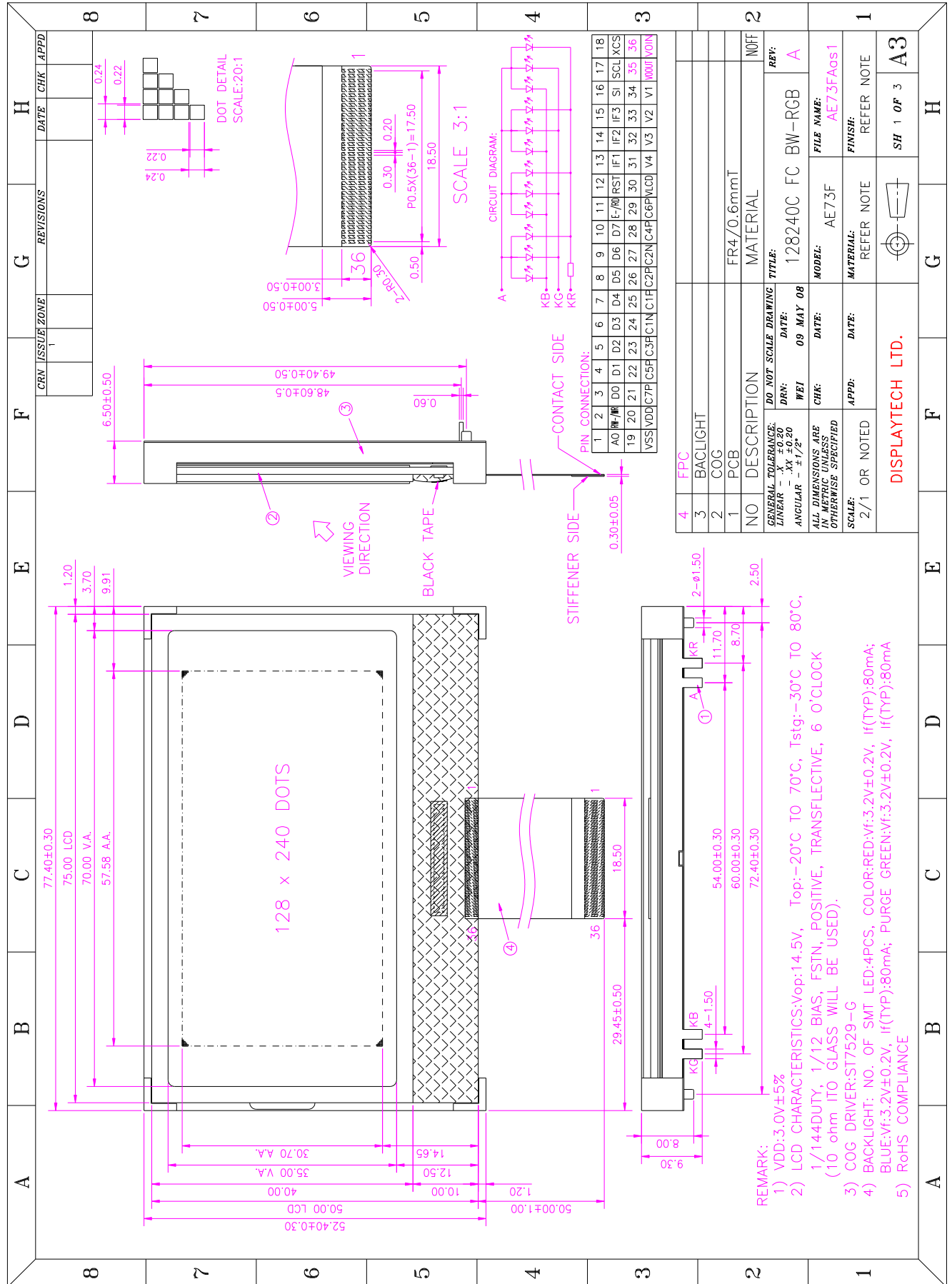



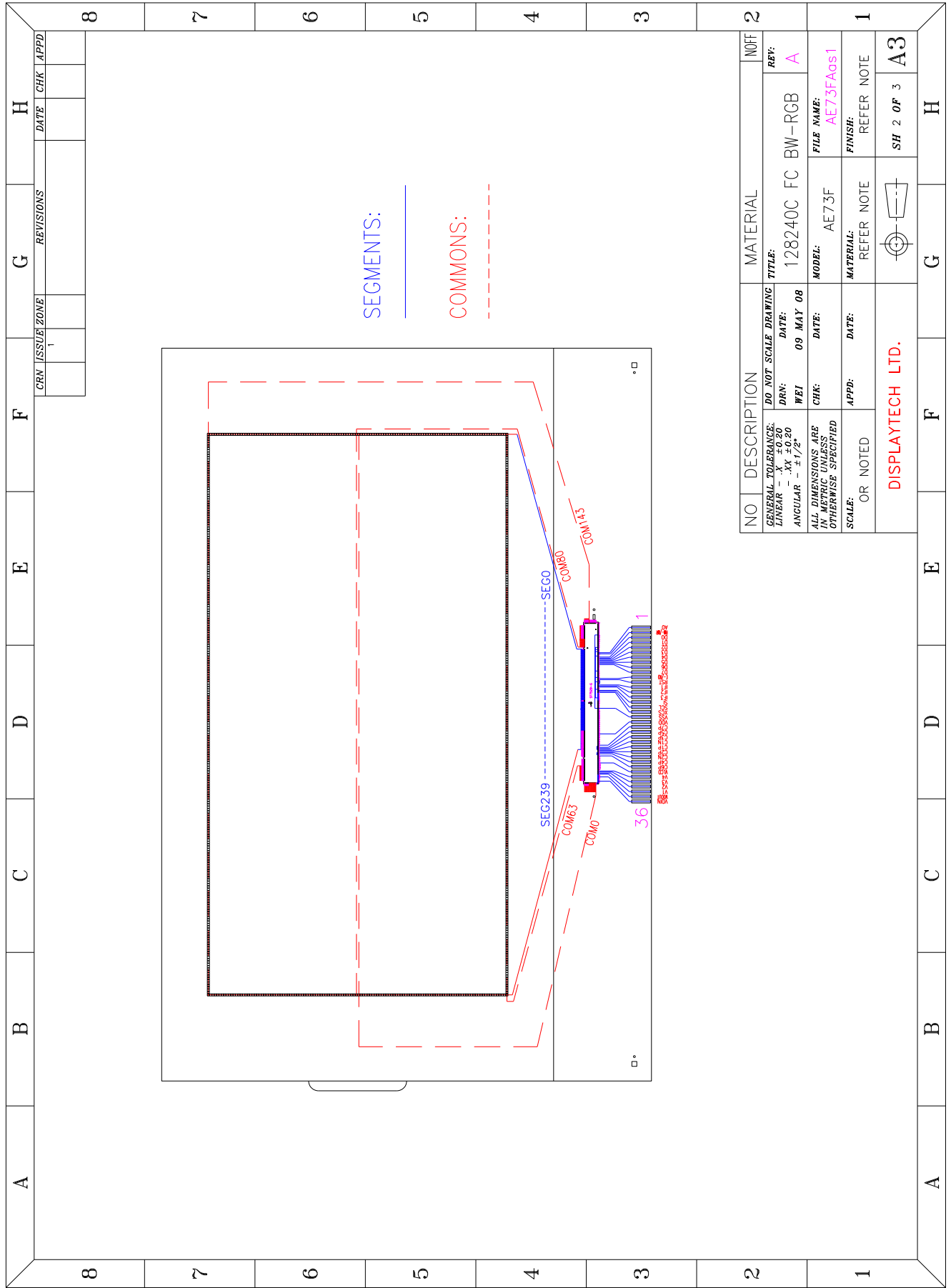

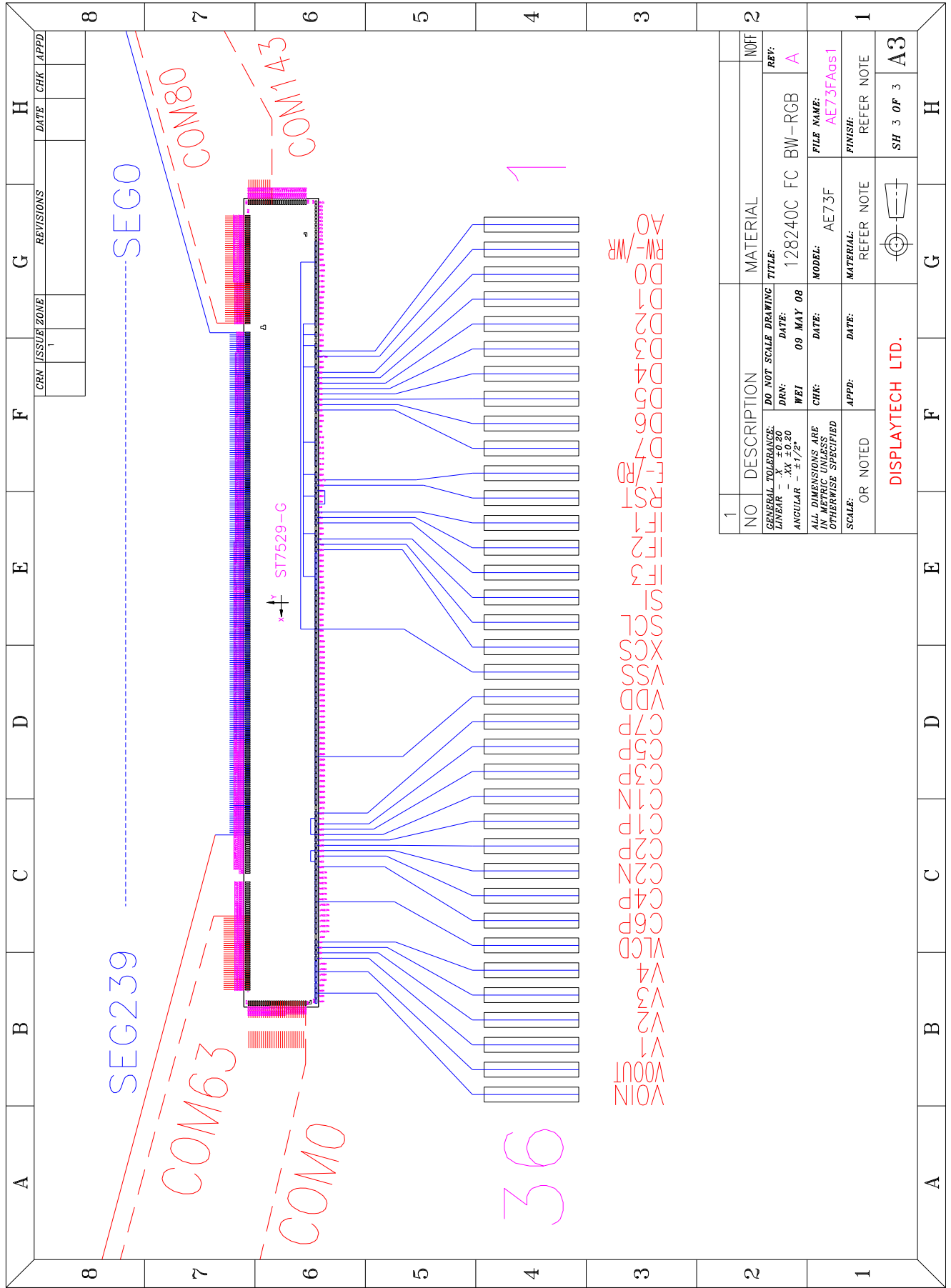

|   |  |   |                      |                      |
|---|--|---|----------------------|----------------------|
| 1 | NO   | DESCRIPTION   | MATERIAL             | NOFF                 |
| 2 | GENERAL TOLERANCE:<br>LINEAR - $\pm 0.20$<br>ANGULAR - $\pm 1/2^\circ$ | DO NOT SCALE DRAWING<br>DATE: 09 MAY 08<br>DRN: WEI<br>CHK: APPD: | 128240C FC BW-RGB    | REV: A               |
| 3 | ALL DIMENSIONS ARE UNLESS OTHERWISE SPECIFIED                          | SCALE: OR NOTED   | MODEL: AE73F         | FILE NAME: AE73FAos1 |
| 4 |  |   | MATERIAL: REFER NOTE | FINISH: REFER NOTE   |
| 5 |  |   |                      | SH 3 OF 3            |
| 6 |  |   |                      | A3                   |
| 7 |  |   |                      |                      |
| 8 |  |   |                      |                      |

DISPLAYTECH LTD.

■ BACKLIGHT DRAWING

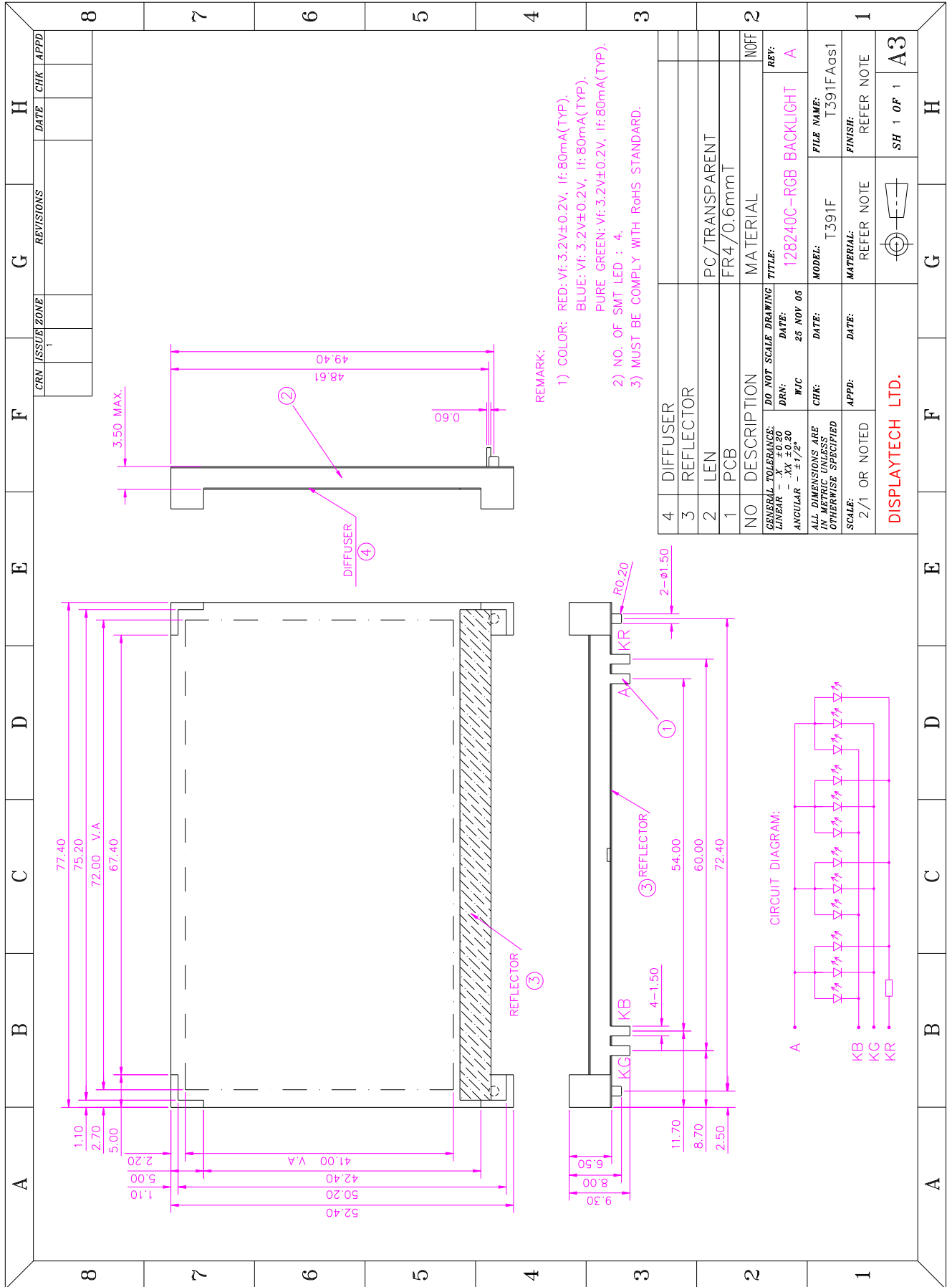

REMARK:

- COLOR: RED: Vf: 3.2V±0.2V, If: 80mA(TYP).  
 BLUE: Vf: 3.2V±0.2V, If: 80mA(TYP).  
 PURE GREEN: Vf: 3.2V±0.2V, If: 80mA(TYP).
- NO. OF SMT LED : 4.
- MUST BE COMPLY WITH RoHS STANDARD.

|  |             |                      |
|--|-------------|----------------------|
| 4                                      | DIFFUSER    |                      |
| 3                                      | REFLECTOR   |                      |
| 2                                      | LEN         | PC/TRANSPARENT       |
| 1                                      | PCB         | FR4/0.6mm T          |
| NO                                     | DESCRIPTION | MATERIAL             |
| GENERAL TOLERANCE:                     |             | DO NOT SCALE DRAWING |
| LINEAR - XX ±0.20                      |             | DRW: 25 NOV 05       |
| ANGULAR - ±1/2°                        |             | DATE: 25 NOV 05      |
| ALL DIMENSIONS ARE OTHERWISE SPECIFIED |             | CHK: T391F           |
| SCALE: 2/1 OR NOTED                    |             | APPR: REFER NOTE     |
| DISPLAYTECH LTD.                       |             | FILE NAME: T391FAos1 |
|  |             | FINISH: REFER NOTE   |
|  |             | SH 1 OP 1 A3         |

■ BACKLIGHT SPECIFICATION

◆ MECHANICAL SPECIFICATIONS

| ITEM                     | NOMINAL DIMENSIONS  | UNIT |
|--------------------------|---------------------|------|
| OUTLINE SIZE (LxWxH)     | 77.40 x 52.40x 9.30 | mm   |
| VIEWING AREA (LxW)       | 72.00 x 41.00       | mm   |
| CONTACT PIN PITCH/LENGTH | NIL                 | mm   |
| NO.OF LED SMT            | 4                   | ---  |

◆ ELECTRICAL/OPTICAL CHARACTERISTICS (Ta=25°C, If=80mA typ.)

| MODE                            | PARAMETER            |                      |                      | UNIT              |
|---------------------------------|----------------------|----------------------|----------------------|-------------------|
|                                 | RED                  | PURE GREEN           | BLUE                 |                   |
| COLOR                           |                      |                      |                      | ---               |
| CHROMATICITY COORDINATE         | X=0.6933<br>Y=0.3000 | X=0.1964<br>Y=0.7334 | X=0.1415<br>Y=0.0619 | ---               |
| AVERAGE LUMINOUS INTENSITY (IV) | MIN: 40<br>TYP: 50   | MIN: 80<br>TYP: 90   | MIN: 20<br>TYP: 30   | cd/m <sup>2</sup> |
| FORWARD VOLTAGE (Vf)            | 3.2 typ              | 3.2 typ              | 3.2 typ              | V                 |

◆ ABSOLUTE MAXIMUM RATING

| ITEM                  | VALUE         |            |      | UNIT |
|-----------------------|---------------|------------|------|------|
|                       | RED           | PURE GREEN | BLUE |      |
| COLOR                 |               |            |      | ---  |
| FORWARD CURRENT       | 120mA         |            |      | If   |
| REVERSE VOLTAGE       | 5V            |            |      | Vr   |
| POWER DISSIPATION     | 384mW         |            |      | Pd   |
| OPERATING TEMPERATURE | -20°C TO 70°C |            |      | Top  |
| STORAGE TEMPERATURE   | -30°C TO 80°C |            |      | Tstg |

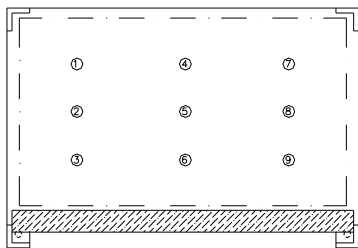

TESTING POINTS

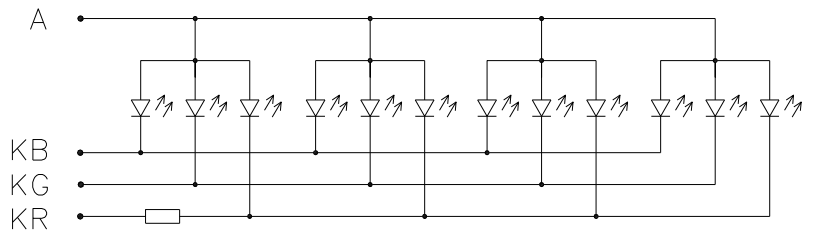

CIRCUIT DIAGRAM

REMARK:

1. AVERAGE LUMINOUS INTENSITY IS THE AVERAGE VALUE OF THE NINE INDICATED POINTS AS SHOWN.
2. MEASUREMENT INSTRUMENT: BM-7, APERTURE: 10mm.

## ■ QUALITY GUARANTEE

◆ **PURPOSE:** It is to define the inspection standard of LCD modules

### ◆ **PRODUCT STANDARD**

#### 1) INSPECTION AND TEST

- FUNCTION TEST
- APPEARANCE INSPECTION
- PACKING SPECIFICATION

#### 2) INSPECTION CONDITION

- Put under the lamp (20w×2) at a distance 100mm from the LCD Modules.
- Tilt upright 45 degree by the front (back) to inspect LCD appearance.

#### 3) AQL INSPECTION LEVEL

- SAMPLING METHOD : MIL-STD-105D
- SAMPLING PLAN : SINGLE
- MAJOR DEFECT : 0.65% (MAJOR)
- MINOR DEFECT : 2.5% (MINOR)
- GENERAL LEVEL : II/NORMAL

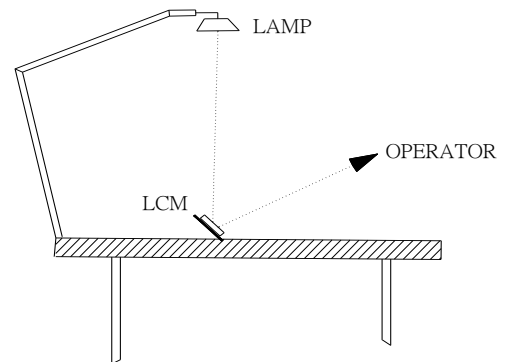

### ◆ **DISPLAY AREA DEFINITION:**

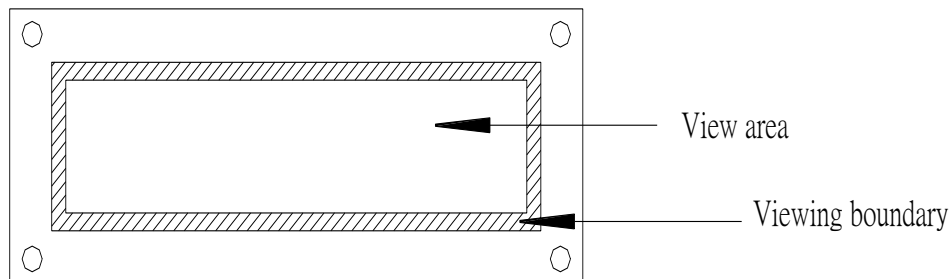

◆ INSPECTION STANDARD

1) FUNCTIONAL TEST STANDARD

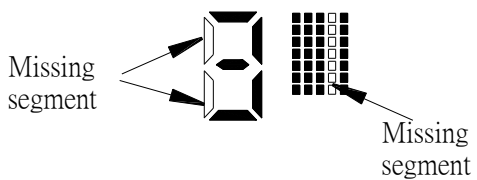
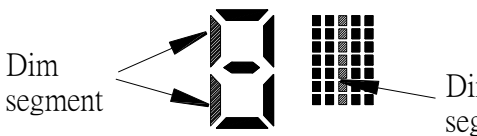
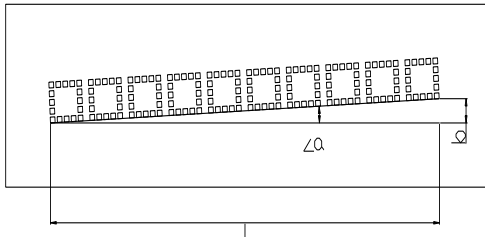
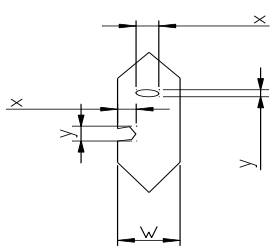
| Item    | Inspection Standard Description  |   | Standard                        | Defect type |        |  |
|---------|--|---|---------------------------------|-------------|--------|--|
| 1       | LCD has no display   |   | Reject                          | MAJ         |        |  |
| 2       | LCM display do not change  |   | Reject                          | MAJ         |        |  |
| 3       | Display wrong pattern  |   | Reject                          | MAJ         |        |  |
| 4       | Display segment open   |   | Reject                          | MAJ         |        |  |
| 5       | Display dim segment  |   | Reject                          | MAJ         |        |  |
| 6       | Wrong LCD viewing direction  |   | Reject                          | MAJ         |        |  |
| 7       | Dim Display  |   | See sample                      | MAJ         |        |  |
| 8       | LCD color variation  |   | See sample                      | MAJ         |        |  |
| 9       | Pattern parallelism<br> | Acceptable range  |                                 |             |        |  |
|         |  | L   | <a                              | b           |        |  |
|         |  | ≧ 20mm  | 0.43°                           | ≧ 0.15mm    |        |  |
|         |  | ≧ 30mm  | 0.38°                           | ≧ 0.2mm     |        |  |
|         |  | ≧ 40mm  | 0.43°                           | ≧ 0.3mm     |        |  |
|         |  | ≧ 50mm  | 0.40°                           | ≧ 0.35mm    |        |  |
|         |  | ≧ 60mm  | 0.43°                           | ≧ 0.45mm    |        |  |
|         |  | ≧ 70mm  | 0.41°                           | ≧ 0.50mm    |        |  |
|         |  | ≧ 80mm  | 0.43°                           | ≧ 0.60mm    |        |  |
|         |  | ≧ 90mm  | 0.41°                           | ≧ 0.65mm    |        |  |
| ≧ 100mm | 0.43°  | ≧ 0.75mm  |                                 |             |        |  |
| Accept  |  |   |                                 |             |        |  |
| 10      | LCD display Pin hole   |  | Standard                        |             |        |  |
|         |  |   | $\varnothing = \frac{x + y}{2}$ | QTY         |        |  |
|         |  |   | $\varnothing \leq 0.25$         | 1           | Accept |  |
|         |  |   | $\varnothing > 0.25$            | 1           | Accept |  |
|         |  |   | $\varnothing < \frac{1}{4} W$   | 1           | Accept |  |
|         |  | $\varnothing > \frac{1}{4} W$   | 1                               | Reject      | MIN    |  |

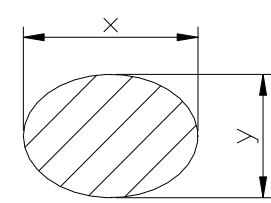

| Item | Inspection Standard Description             | Standard  | Defect type                                |     |        |     |
|------|---|---|--|-----|--------|-----|
| 11   | LCD display<br>Broken segment(dots)         | Draw  |  |     |        |     |
|      |   | Standard  |  |     |        |     |
|      |   | X   | y  | QTY |        |     |
|      |   | $\geq \frac{1}{4}b$   | $\geq \frac{1}{4}a$                        | 1   | Reject | MIN |
|      |   | $(X \text{ or } y) \geq 0.2\text{mm}$   |  | 1   | Reject | MIN |
| 12   | LCD display<br>Black spot or<br>White spot  |  |  |     |        |     |
|      |   |   | $\frac{x+y}{2}$                            | QTY |        |     |
|      |   |   | $\emptyset < 0.10$                         |     | Accept |     |
|      |   |   | $0.1 < \emptyset \leq 0.20$                | 2   | Accept |     |
|      |   |   | $0.20 \leq \emptyset < 0.25$               | 1   | Accept |     |
| 13   | LCD display excess black line or white line | Black line/white line(Lxw)mm  | QTY  |     |        |     |
|      |   |   | $(L \leq 1.0) \times (W \leq 0.025)$       | 2   | Accept |     |
|      |   |   | $(1.0 < L \leq 1.5) \times (W \leq 0.025)$ | 1   | Accept |     |
|      |   |   | $(L > 1.5) \times (W \leq 0.025)$          | 0   | Reject | MIN |
|      |   |   | $(L > 2) \times (W > 0.025)$               | 0   | Reject | MAJ |
| 14   | Backlight not function                      |   | Reject                                     | MAJ |        |     |
| 15   | LED not function or dim                     |   | Reject                                     | MIN |        |     |
| 16   | Backlight defect (dirt, scratch)            |   | Reject                                     | MIN |        |     |

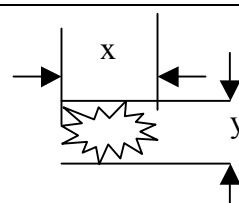
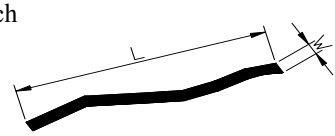
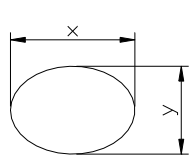
2) COSMETIC INSPECTION STANDARD

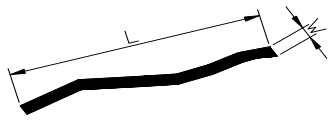
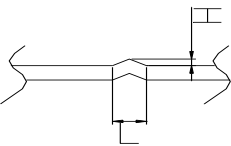
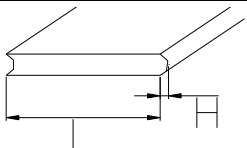
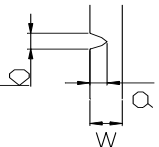
| Item     | Standard description of inspection | Standard  | Defect type                    |                |        |        |     |
|----------|------------------------------------|---|--------------------------------|----------------|--------|--------|-----|
| <b>1</b> | <b>LCD inspection item</b>         |   |                                |                |        |        |     |
| 1.1      | LCD color variation                | See sample  | MIN                            |                |        |        |     |
| 1.2      | LCD broken                         | Reject  | MAJ                            |                |        |        |     |
| 1.3      | Wrong polarizer of LCD             | Reject  | MAJ                            |                |        |        |     |
| 1.4      | Spot on LCD surface                | Reject  | MAJ                            |                |        |        |     |
| 1.5      | Scratch on LCD                     |  | Scratch = $\emptyset$          | QTY            |        |        |     |
|          |                                    |   | $\emptyset < 0.1$              | Except         | Accept |        |     |
|          |                                    |   | $0.1 \leq \emptyset \leq 0.15$ | 2              | Accept |        |     |
|          |                                    |   | $0.15 < \emptyset \leq 0.25$   | 1              | Accept |        |     |
|          |                                    |   | $\emptyset > 0.25$             | 1              | Reject | MIN    |     |
| 1.6      | LCD scratch                        |  | Scratch = L                    | scratch = W    | QTY    |        |     |
|          |                                    |   |                                | $W \leq 0.015$ |        | Accept |     |
|          |                                    |   | $< 0.5$                        | $W \leq 0.02$  | 2      | Accept |     |
|          |                                    |   | $< 1.0$                        | $W \leq 0.03$  | 1      | Accept |     |
|          |                                    |   | $\geq 1.0$                     | $W \geq 0.03$  | 1      | Reject | MIN |
| 1.7      | White or black spot on LCD         |  |                                | QTY            |        |        |     |
|          |                                    |   | $\emptyset < 0.1$              |                | Accept |        |     |
|          |                                    |   | $0.1 \leq \emptyset < 0.2$     | 2              | Accept |        |     |
|          |                                    |   | $0.2 \leq \emptyset \leq 0.25$ | 1              | Accept |        |     |
|          |                                    |   | $\emptyset > 0.25$             | 1              | Reject | MIN    |     |
|          | Bevy point                         | -   | Reject                         | MIN            |        |        |     |

| Item                | Standard description of inspection   |                                   |                              | Standard                 | Defect type |     |
|---------------------|--|-----------------------------------|------------------------------|--------------------------|-------------|-----|
| 1.8                 | Black line in LCD<br>                 | (L)                               | (W)                          | QTY                      |             |     |
|                     |  | $L \leq 1.0$                      | $W \leq 0.025$               | 2                        | Accept      |     |
|                     |  | $1.0 < L \leq 1.5$                | $W \leq 0.025$               | 1                        | Accept      |     |
|                     |  | $1.5 < L$                         | $W > 0.025$                  | 1                        | Reject      | MIN |
| 1.9                 | Round air bubble   | Size                              | QTY                          |                          |             |     |
|                     |  | $\varnothing < 0.15$              | 2                            | Accept                   |             |     |
|                     |  | $0.15 \leq \varnothing \leq 0.25$ | 1                            | Accept                   |             |     |
|                     |  | $\varnothing > 0.25$              | 0                            | Reject                   | MIN         |     |
| 1.10                | Line defect  | (L)                               | (W)                          | QTY                      |             |     |
|                     |  | $L < 0.5$                         | $W < 0.02$                   | 2                        | Accept      |     |
|                     |  | $L < 1.0$                         | $W < 0.03$                   | 1                        | Accept      |     |
|                     |  | $L \geq 1.0$                      | $W \geq 0.3$                 | 0                        | Reject      | MIN |
| 1.11                | Finger print   |                                   |                              | Reject                   | MIN         |     |
| <b>2</b>            | <b>PCB/COB specification</b>   |                                   |                              |                          |             |     |
| 2.1                 | PCB deformity<br>                     | L                                 | H                            |                          |             |     |
|                     |  | $\leq 6.0\text{mm}$               | $\leq 1.5\text{mm}$          | Accept                   |             |     |
|                     |  | $> 6.0\text{mm}$                  | $\leq 1.5\text{mm}$          | Reject                   | MIN         |     |
|                     |  | $< 6.0\text{mm}$                  | $> 1.5\text{mm}$             | Reject                   | MIN         |     |
|                     |  | $> 6.0\text{mm}$                  | $> 1.5\text{mm}$             | Reject                   | MIN         |     |
| 2.2                 | Deformity at PCB edge, damage circuit.   |                                   |                              | Reject                   | MAJ         |     |
| 2.3                 | Convex at PCB edge<br>               | L                                 | H                            |                          |             |     |
|                     |  | $\leq 6.0\text{mm}$               | $\leq 1.5\text{mm}$          | Accept                   |             |     |
|                     |  | $> 6.0\text{mm}$                  | $\leq 1.5\text{mm}$          | Reject                   | MIN         |     |
|                     |  | $< 6.0\text{mm}$                  | $> 1.5\text{mm}$             | Reject                   | MIN         |     |
|                     |  | $> 6.0\text{mm}$                  | $> 1.5\text{mm}$             | Reject                   | MIN         |     |
| 2.4                 | Damage excess 2x2mm at the PCB corner  |                                   |                              | Reject                   | MIN         |     |
| 2.5                 | Scratch on PCB surface   |                                   |                              | See sample               | MIN         |     |
| 2.6                 | Scratch on PCB coat/leakage coat on PCB surface  |                                   |                              | Reject                   | MAJ         |     |
| 2.7                 | Open circuit   |                                   |                              | Reject                   | MAJ         |     |
| 2.8                 | PCB PTH open   |                                   |                              | Reject                   | MAJ         |     |
| 2.9                 | Repair PCB PTH   |                                   | $QTY \leq 2\text{PCS}$       | Accept                   |             |     |
|                     |  |                                   | $QTY \geq 3\text{PCS}$       | Reject                   | MAJ         |     |
| 2.10                | Color different from one side to another side.   |                                   |                              | Reject                   | MIN         |     |
| 2.11                | Repaired solder mask area  |                                   | $\leq 30\text{mm}^2$         | Accept                   |             |     |
|                     |  |                                   | $\geq 30\text{mm}^2$         | Reject                   | MIN         |     |
| 2.12                | Scratch circuit, damage Circuit<br> |                                   | $a \leq 1/2w$ or $b < w$     | Accept                   |             |     |
|                     |  |                                   | $a > 1/2w$ or $b > w$        | Reject                   |             |     |
| <b>3</b>            | <b>Bezel specification</b>   |                                   |                              |                          |             |     |
| 3.1                 | Wrong Materials  |                                   |                              |                          | MAJ         |     |
| 3.2                 | Incorrect dimension  |                                   |                              |                          | MAJ         |     |
| 3.3                 | Bezel broken   |                                   |                              |                          | MAJ         |     |
| 3.4                 | Rust on Bezel  |                                   |                              |                          | MAJ         |     |
| 3.5                 | Hole or dirty on oil Paint surface   | Top surface                       | Size                         | $\text{cm}^2/\text{per}$ |             |     |
|                     |  |                                   | $\varnothing \leq 0.3$       | 2                        | Accept      |     |
|                     |  |                                   | $0.3 < \varnothing \leq 0.5$ | 1                        | Accept      |     |
|                     |  | $\varnothing > 0.5$               | 0                            | Reject                   | MIN         |     |
|                     |  | Side                              | $\varnothing \leq 0.5$       | 2                        | Accept      |     |
|                     |  |                                   | $0.5 < \varnothing \leq 0.8$ | 1                        | Accept      |     |
| $\varnothing > 0.8$ | 0  |                                   | Reject                       | MIN                      |             |     |

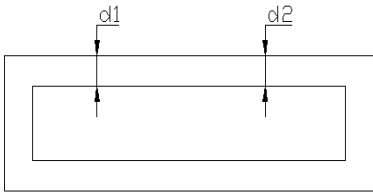
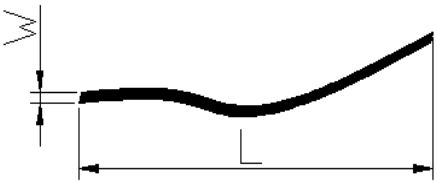
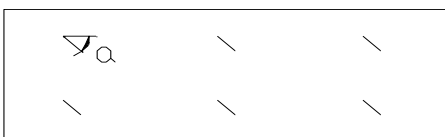
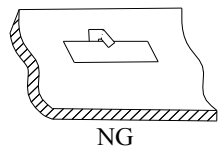
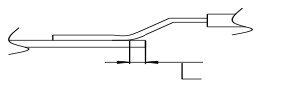

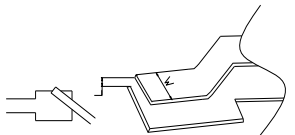
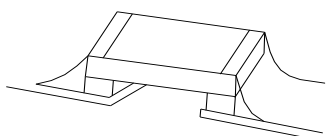
| Item       | Standard description of inspection  |   | Standard  | Defect type   |             |            |  |
|------------|---|---|---|---------------|-------------|------------|--|
| 3.6        | Bezel bow or twist  | $h \leq 0.01$ mm/mm   | Accept  |               |             |            |  |
|            |   | $h > 0.01$ mm/mm  | Reject  | MIN           |             |            |  |
| 3.7        |  | $d1 - d2 \leq \text{tolerance}$   | Accept  |               |             |            |  |
|            |   | $d1 - d2 > \text{tolerance}$  | Reject  | MIN           |             |            |  |
| 3.8        | Scratch on bezel  |          | Face  |               | Accept QTY  | See Sample |  |
|            |   |   | L   | W             | Not defined |            |  |
|            |   |   | -   | $W \leq 0.15$ |             |            |  |
|            |   |   | $L \leq 3$  | $W \leq 0.20$ | 2           |            |  |
|            |   |   | $L \leq 2$  | $W \leq 0.3$  | 2           |            |  |
|            |   |   | -   | $W > 0.3$     |             |            |  |
|            |   |   | side  |               | Accept QTY  |            |  |
|            |   |   | L   | W             |             |            |  |
| -          | $W \leq 0.2$  | except  |   | See Sample    |             |            |  |
| $L \leq 3$ | $W \leq 0.25$   | 2   |   |               |             |            |  |
| $L \leq 2$ | $W \leq 0.3$  | 2   |   |               |             |            |  |
|            |   |   |   |               |             |            |  |
| 3.9        | Twist angle $\alpha = 45^\circ \pm 5^\circ$                                       |       |   | Accept        |             |            |  |
| 3.10       | Void gap between bezel and PCB  |   | Reject  | MIN           |             |            |  |
| 3.11       | Bezel clip incorrectly  | <br>NG | Reject  | MIN           |             |            |  |
| <b>4</b>   | <b>Solder specification</b>   |   |   |               |             |            |  |
| 4.1        | Wrong component   |   | Reject  | MAJ           |             |            |  |
| 4.2        | Broken component  |   | Reject  | MAJ           |             |            |  |
| 4.3        | Mis-alignment   |        | Component legs extend beyond the pad and<br>Legs $>$ pad distance(w) on solder area $> W^2$ | Accept        |             |            |  |
|            |   |        | Component legs extend beyond the pad and<br>Legs $>$ pad distance(w) on solder area $< W^2$ | Reject        | MIN         |            |  |
|            | Component Offset  |        | Solder legs offset distance $L <$ solder legs<br>$1/4W$                                     | Accept        |             |            |  |
|            |   |   | Solder legs offset $L > 1/4W$   | Reject        | MIN         |            |  |
| 4.4        | Component assembly defect   |       | Reject  | MIN           |             |            |  |
| 4.5        | CHIP components hoist $\leq 0.5$ mm   |   | Accept  |               |             |            |  |
| 4.6        | CHIP components hoist $> 0.5$ mm  |   | Reject  | MIN           |             |            |  |

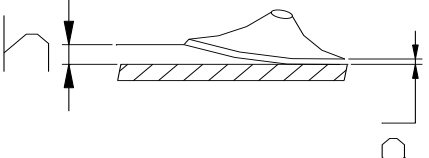
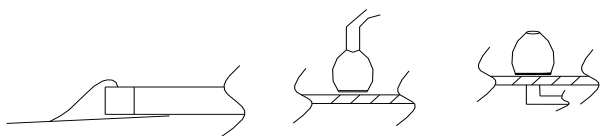
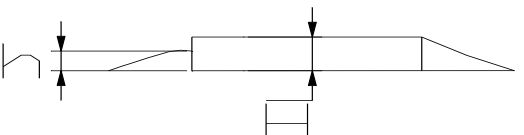
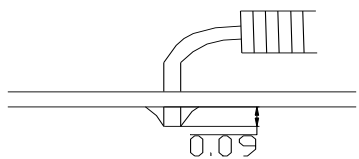
| Item     | Standard description of inspection  | Standard              | Defect type |
|----------|---|-----------------------|-------------|
| 4.7      | Components hoist  | $h \leq 2.0\text{mm}$ | Accept      |
|          |   | $h > 2.0\text{mm}$    | Reject MIN  |
| 4.8      | Switch (socket) hoist   | $h \leq 0.5\text{mm}$ | Accept      |
|          |   | $h > 0.5\text{mm}$    | Reject MIN  |
| 4.9      | Components cold solder or incomplete solder   | Reject                | MAJ         |
| 4.10     | Solder PAD tilt up, but height (h) less than Solder PAD thickness (a)<br> | Accept                |             |
| 4.11     | Excess solder above components<br>  | Reject                | Min         |
| 4.12     | Insufficient solder below components height or less than diameter<br>    | Reject                | MIN         |
| 4.13     | Solder area less than soldering PAD Area by 2/3   | Reject                | MIN         |
| 4.14     | Trimmed pin length beyond 0.09inch (2.3mm)<br>                          | Reject                | Min         |
| <b>5</b> | <b>Packing specification</b>  |                       |             |
| 5.1      | Wrong carton mark.  | Reject                | MAJ         |
| 5.2      | Carton mark problem   | Reject                | MIN         |
| 5.3      | Carton damage extend than 150mm   | Reject                | MAJ         |
| 5.4      | Carton damage, scratch more 50mm, less 150mm.   | Reject                | MIN         |

## ■ PRECAUTIONS FOR USING LCD MODULES

### ◆ HANDLING PRECAUTIONS

1. This device is susceptible to Electro-Static Discharge (ESD) damage. Observe Anti-Static precautions.
2. The display panel is made of glass. Do not subject it to a mechanical shock by dropping it or impact.
3. If the display panel is damaged and the liquid crystal substance leaks out, be sure not to get any in your mouth. If the substance contacts your skin or clothes, wash it off using soap and water.
4. Do not apply excessive force to the display surface or the adjoining areas since this may cause the color tone to vary.
5. The polarizer covering the display surface of the LCD module is soft and easily scratched. Handle this polarizer carefully.
6. If the display surface becomes contaminated, breathe on the surface and gently wipe it with a soft dry cloth. If it is heavily contaminated, moisten cloth with one of the following solvents:
  - Isopropyl alcohol
  - Ethyl alcohol
7. Solvents other than those above-mentioned may damage the polarizer. Especially, do not use the following.
  - Water
  - Ketone
  - Aromatic solvents
8. Exercise care to minimize corrosion of the electrode. Corrosion of the electrodes is accelerated by water droplets, moisture condensation or a current flow in a high-humidity environment.
9. Install the LCD Module by using the mounting holes. When mounting the LCD module make sure it is free of twisting, warping and distortion. In particular, do not forcibly pull or bend the I/O cable or the backlight cable.
10. Do not attempt to disassemble or process the LCD module.
11. NC terminal should be open. Do not connect anything.
12. If the logic circuit power is off, do not apply the input signals.
13. To prevent destruction of the elements by static electricity, be careful to maintain an optimum work environment.
  - Be sure to ground the body when handling the LCD modules.
  - Tools required for assembling, such as soldering irons, must be properly grounded.
  - To reduce the amount of static electricity generated, do not conduct assembling and other work under dry conditions.
  - The LCD module is coated with a film to protect the display surface. Exercise care when peeling off this protective film since static electricity may be generated.

### ◆ POWER SUPPLY PRECAUTIONS:

1. Identify and, at all times, observe absolute maximum ratings for both logic and LC drivers. Note that there is some variance between models.
2. Prevent the application of reverse polarity to VDD and VSS, however briefly.
3. Use a clean power source free from transients. Power-up conditions are occasionally “jolting” and may exceed the maximum ratings of the modules.
4. The VDD power of the module should also supply the power to all devices that may access the display. Don’t allow the data bus to be driven when the logic supply to the module is turned off.

### ◆ OPERATING PRECAUTIONS:

1. DO NOT plug or unplug the module when the system is powered up.
2. Minimize the cable length between the module and the host MPU.
3. For models with EL backlights, do not disable the backlight by interrupting the HV line. Unload inverters produce voltage extremes that may arc within a cable or at the display.
4. Operate the module within the limits of the modules temperature specifications.

### ◆ MECHANICAL/ENVIRONMENTAL PRECAUTIONS:

1. Improper soldering is the major cause of module difficulty. Use of flux cleaner is not recommended as they may seep under the elastomeric connection and cause display failure.
2. Mount the module so that it is free from torque and mechanical stress.
3. Surface of the LCD panel should not be touched or scratched. The display front surface is an easily scratched, plastic polarizer. Avoid contact and clean only when necessary with soft, absorbent cotton dampened with petroleum benzene.
4. Always employ anti-static procedure while handling the module.
5. Prevent moisture build-up upon the module and observe the environmental constraints for storage temperature and humidity.
6. Do not store in direct sunlight
7. If leakage of the liquid crystal material should occur, avoid contact with this material, particularly ingestion. If the body or clothing becomes contaminated by the liquid crystal material, wash thoroughly with water and soap

### ◆ Storage Precautions

When storing the LCD modules, avoid exposure to direct sunlight or to the light of fluorescent lamps. Keep the modules in bags (avoid high temperature / high humidity and low temperatures below 0°C). Whenever possible, the LCD modules should be stored in the same conditions in which they were shipped from our company.

### ◆ Others

Liquid crystals solidify under low temperature (below the storage temperature range) leading to defective orientation or the generation of air bubbles (black or white). Air bubbles may also be generated if the module is subject to a low temperature.

If the LCD modules have been operating for a long time showing the same display patterns, the display patterns may remain on the screen as ghost images and a slight contrast irregularity may also appear. A normal operating status can be regained by suspending use for some time. It should be noted that this phenomenon does not adversely affect performance reliability.

To minimize the performance degradation of the LCD modules resulting from destruction caused by static electricity etc., exercise care to avoid holding the following sections when handling the modules.

- Exposed area of the printed circuit board.
- Terminal electrode sections.

## ■ USING LCD MODULES

### ◆ Liquid Crystal Display Modules

LCD is composed of glass and polarizer. Pay attention to the following items when handling.

1. Please keep the temperature within specified range for use and storage. Polarization degradation, bubble generation or polarizer peel-off may occur with high temperature and high humidity.
2. Do not touch, push or rub the exposed polarizers with anything harder than an HB pencil lead (glass, tweezers, etc.).
3. N-hexane is recommended for cleaning the adhesives used to attach front/rear polarizers and reflectors made of organic substances that will be damaged by chemicals such as acetone, toluene, ethanol and isopropylalcohol.
4. When the display surface becomes dusty, wipe gently with absorbent cotton or other soft material like chamois soaked in petroleum benzin. Do not scrub hard to avoid damaging the display surface.
5. Wipe off saliva or water drops immediately, contact with water over a long period of time may cause deformation or color fading.
6. Avoid contacting oil and fats.
7. Condensation on the surface and contact with terminals due to cold will damage, stain or dirty the polarizers. After products are tested at low temperature they must be warmed up in a container before coming in contact with room temperature air.
8. Do not put or attach anything on the display area to avoid leaving marks on.
9. Do not touch the display with bare hands. This will stain the display area and degradate insulation between terminals (some cosmetics are determined to the polarizers).
10. As glass is fragile. It tends to become or chipped during handling especially on the edges. Please avoid dropping or jarring.

### ◆ Installing LCD Modules

1. When assembling the LCM into other equipment, the spacer to the bit between the LCM and the fitting plate should have enough height to avoid causing stress to the module surface, refer to the individual specifications for measurements. The measurement tolerance should be  $\pm 0.1$ mm.

### ◆ Precaution for Handling LCD Modules

Since LCM has been assembled and adjusted with a high degree of precision, avoid applying excessive shocks to the module or making any alterations or modifications to it.

1. Do not alter, modify or change the shape of the tab on the metal frame.
2. Do not make extra holes on the printed circuit board, modify its shape or change the positions of components to be attached.
3. Do not damage or modify the pattern writing on the printed circuit board.
4. Absolutely do not modify the zebra rubber strip (conductive rubber) or heat seal connector.
5. Except for soldering the interface, do not make any alterations or modifications with a soldering iron.
6. Do not drop, bend or twist LCM.

◆ **Electro-Static Discharge Control**

Since this module uses a CMOS LSI, the same careful attention should be paid to electrostatic discharge as for an ordinary CMOS IC.

1. Make certain that you are grounded when handing LCM.
2. Before remove LCM from its packing case or incorporating it into a set, be sure the module and your body have the same electric potential.
3. When soldering the terminal of LCM, make certain the AC power source for the soldering iron does not leak.
4. When using an electric screwdriver to attach LCM, the screwdriver should be of ground potentiality to minimize as much as possible any transmission of electromagnetic waves produced sparks coming from the commutator of the motor.
5. As far as possible make the electric potential of your work clothes and that of the workbench the ground potential.
6. To reduce the generation of static electricity is careful that the air in the work is not too dried. A relative humidity of 50%-60% is recommended.

◆ **Precaution for soldering to the LCM**

1. Observe the following when soldering lead wire, connector cable and etc. to the LCM.
  - Soldering iron temperature: 280°C ± 10°C.
  - Soldering time: 3-4 sec.
  - Solder: eutectic solder.

If soldering flux is used, be sure to remove any remaining flux after finishing to soldering operation. (This does not apply in the case of a non-halogen type of flux.) It is recommended that you protect the LCD surface with a cover during soldering to prevent any damage due to flux spatters.

2. When soldering the electroluminescent panel and PC board, the panel and board should not be detached more than three times. This maximum number is determined by the temperature and time conditions mentioned above, though there may be some variance depending on the temperature of the soldering iron.
3. When remove the electroluminescent panel from the PC board, be sure the solder has completely melted, the soldered pad on the PC board could be damaged.

◆ **Precautions for Operation**

1. Viewing angle varies with the change of liquid crystal driving voltage (VO). Adjust VO to show the best contrast.
2. Driving the LCD in the voltage above the limit shortens its life.
3. Response time is greatly delayed at temperature below the operating temperature range. However, this does not mean the LCD will be out of the order. It will recover when it returns to the specified temperature range.
4. If the display area is pushed hard during operation, the display will become abnormal. However, it will return to normal if it is turned off and then back on.
5. Condensation on terminals can cause an electrochemical reaction disrupting the terminal circuit. Therefore, it must be used under the relative condition of 40°C, 50% RH.
6. When turning the power on, input each signal after the positive/negative voltage becomes stable.

