



Chipsmall Limited consists of a professional team with an average of over 10 year of expertise in the distribution of electronic components. Based in Hongkong, we have already established firm and mutual-benefit business relationships with customers from,Europe,America and south Asia,supplying obsolete and hard-to-find components to meet their specific needs.

With the principle of “Quality Parts,Customers Priority,Honest Operation,and Considerate Service”,our business mainly focus on the distribution of electronic components. Line cards we deal with include Microchip,ALPS,ROHM,Xilinx,Pulse,ON,Everlight and Freescale. Main products comprise IC,Modules,Potentiometer,IC Socket,Relay,Connector.Our parts cover such applications as commercial,industrial, and automotives areas.

We are looking forward to setting up business relationship with you and hope to provide you with the best service and solution. Let us make a better world for our industry!



Contact us

Tel: +86-755-8981 8866 Fax: +86-755-8427 6832

Email & Skype: info@chipsmall.com Web: www.chipsmall.com

Address: A1208, Overseas Decoration Building, #122 Zhenhua RD., Futian, Shenzhen, China





12A02MH

Bipolar Transistor -12V, -1A, Low VCE(sat) PNP Single MCPH3

ON Semiconductor®

<http://onsemi.com>

Applications

- Low-frequency Amplifier, high-speed switching, small motor drive, muting circuit

Features

- Large current capacity
- Low collector-to-emitter saturation voltage (resistance) $R_{CE(sat)}$ typ.=285mΩ [$I_C=1A$, $I_B=50mA$]
- Small ON-resistance (R_{on})

Specifications

Absolute Maximum Ratings at $T_a=25^\circ\text{C}$

Parameter	Symbol	Conditions	Ratings	Unit
Collector-to-Base Voltage	V_{CBO}		-15	V
Collector-to-Emitter Voltage	V_{CEO}		-12	V
Emitter-to-Base Voltage	V_{EBO}		-5	V
Collector Current	I_C		-1	A
Collector Current (Pulse)	I_{CP}		-2	A
Collector Dissipation	P_C	When mounted on ceramic substrate (600mm ² ×0.8mm)	600	mW
Junction Temperature	T_j		150	°C
Storage Temperature	T_{stg}		-55 to +150	°C

Stresses exceeding Maximum Ratings may damage the device. Maximum Ratings are stress ratings only. Functional operation above the Recommended Operating Conditions is not implied. Extended exposure to stresses above the Recommended Operating Conditions may affect device reliability.

Package Dimensions

unit : mm (typ)

7019A-004

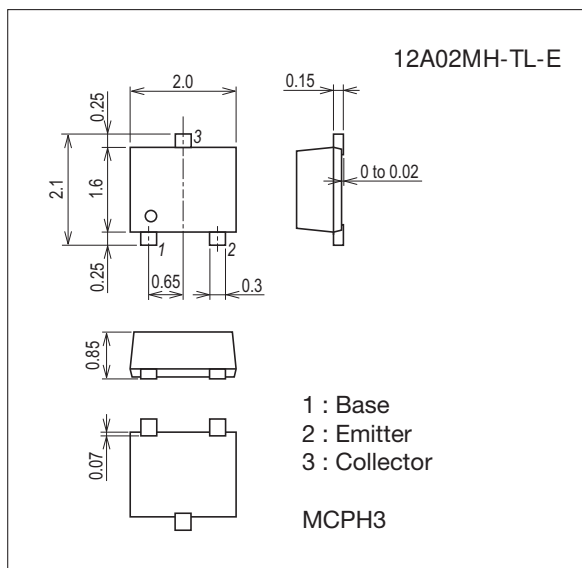

Product & Package Information

- Package : MCPH3
- JEITA, JEDEC : SC-70, SOT-323
- Minimum Packing Quantity : 3,000 pcs./reel

Packing Type : TL

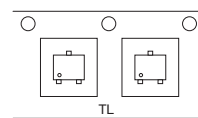

Marking



Electrical Connection

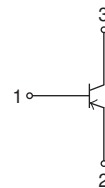

12A02MH

Electrical Characteristics at $T_a=25^\circ\text{C}$

Parameter	Symbol	Conditions	Ratings			Unit
			min	typ	max	
Collector Cutoff Current	I_{CBO}	$V_{CB} = -12\text{V}, I_E = 0\text{A}$			-100	nA
Emitter Cutoff Current	I_{EBO}	$V_{EB} = -4\text{V}, I_C = 0\text{A}$			-100	nA
DC Current Gain	h_{FE}	$V_{CE} = -2\text{V}, I_C = -10\text{mA}$	300		700	
Gain-Bandwidth Product	f_T	$V_{CE} = -2\text{V}, I_C = -50\text{mA}$		450		MHz
Output Capacitance	C_{ob}	$V_{CB} = -10\text{V}, f = 1\text{MHz}$		6		pF
Collector-to-Emitter Saturation Voltage	$V_{CE(sat)}$	$I_C = -400\text{mA}, I_B = -20\text{mA}$		-120	-240	mV
Base-to-Emitter Saturation Voltage	$V_{BE(sat)}$	$I_C = -400\text{mA}, I_B = -20\text{mA}$		-0.9	-1.2	V
Collector-to-Base Breakdown Voltage	$V_{(BR)CBO}$	$I_C = -10\mu\text{A}, I_E = 0\text{A}$	-15			V
Collector-to-Emitter Breakdown Voltage	$V_{(BR)CEO}$	$I_C = -1\text{mA}, R_{BE} = \infty$	-12			V
Emitter-to-Base Breakdown Voltage	$V_{(BR)EBO}$	$I_E = -10\mu\text{A}, I_C = 0\text{A}$	-5			V
Turn-ON Time	t_{on}	See specified Test Circuit.		30		ns
Storage Time	t_{stg}			75		ns
Fall Time	t_f			15		ns

Switching Time Test Circuit

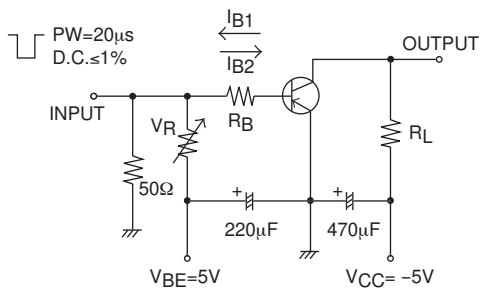

$$I_C = 20I_{B1} = -20I_{B2} = -400\text{mA}$$

Ordering Information

Device	Package	Shipping	memo
12A02MH-TL-E	MCPH3	3,000pcs./reel	Pb Free

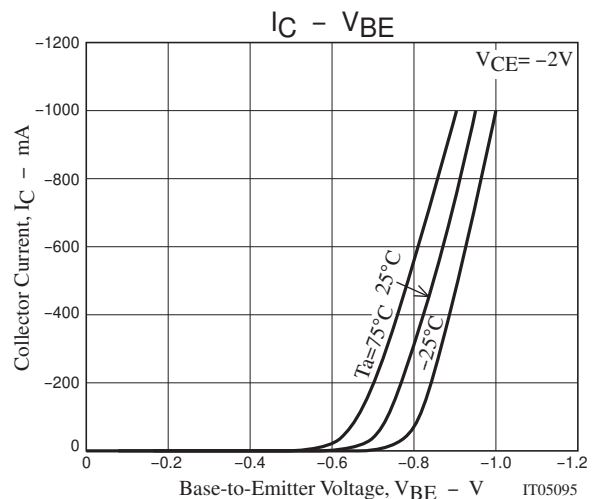
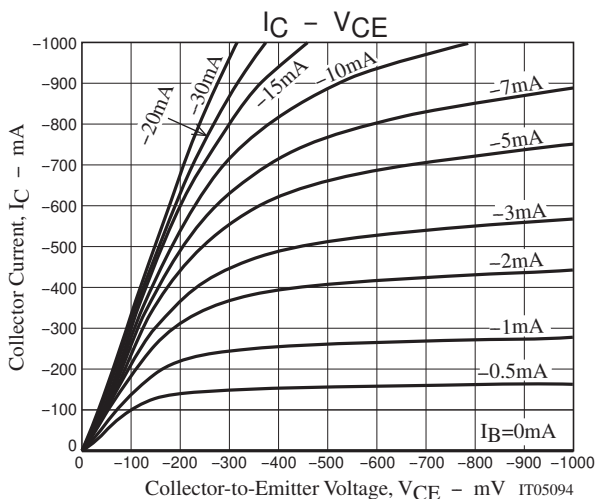

12A02MH

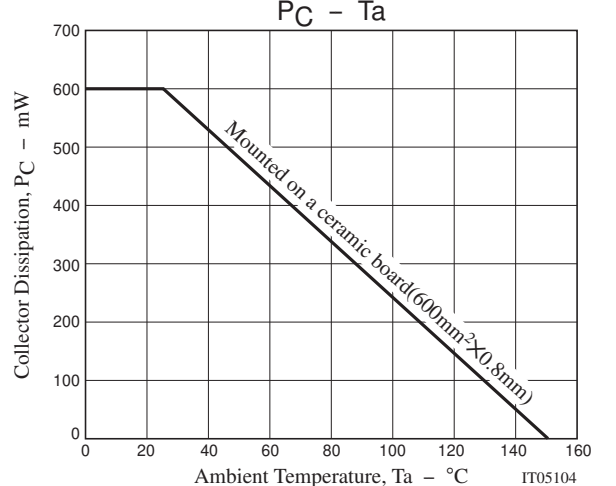
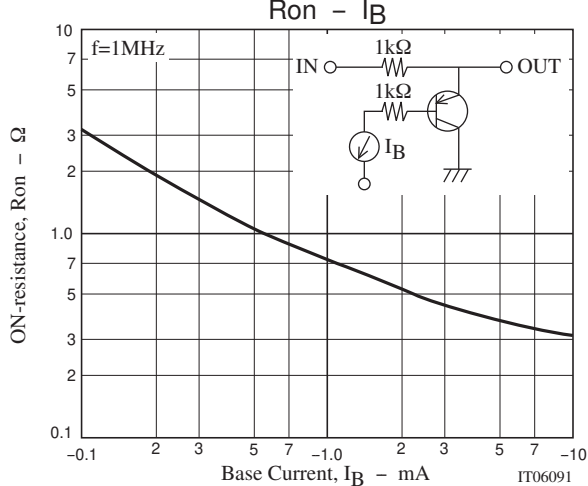
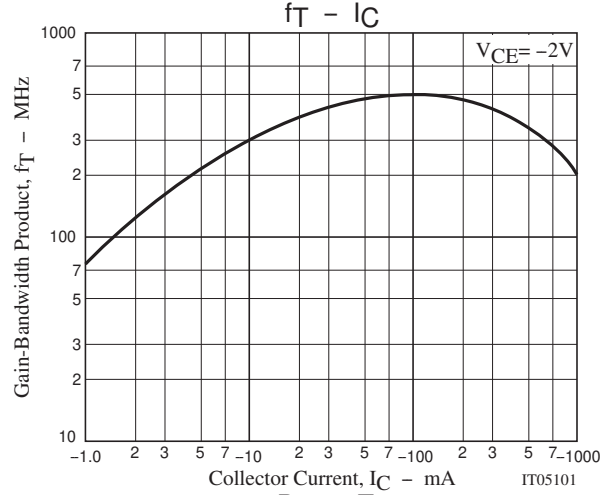
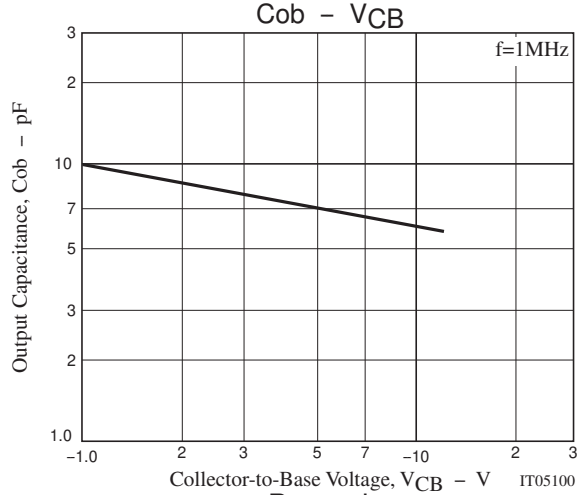
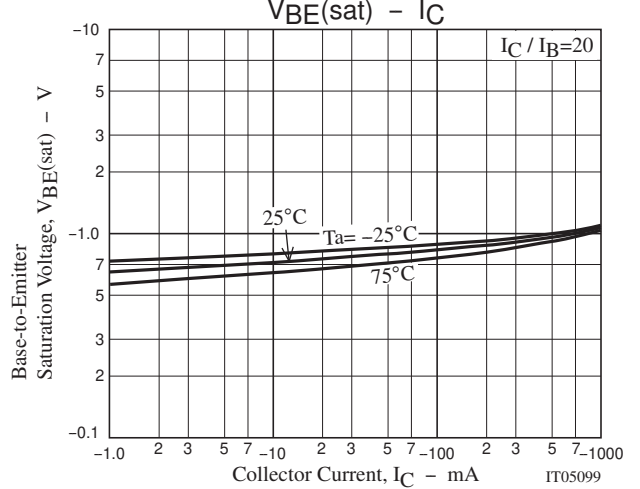
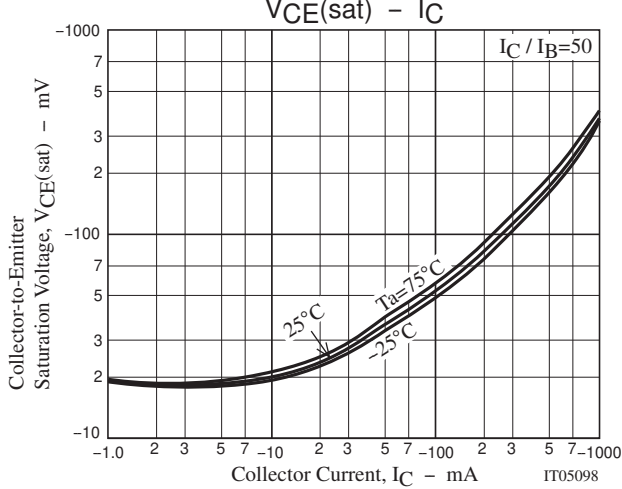
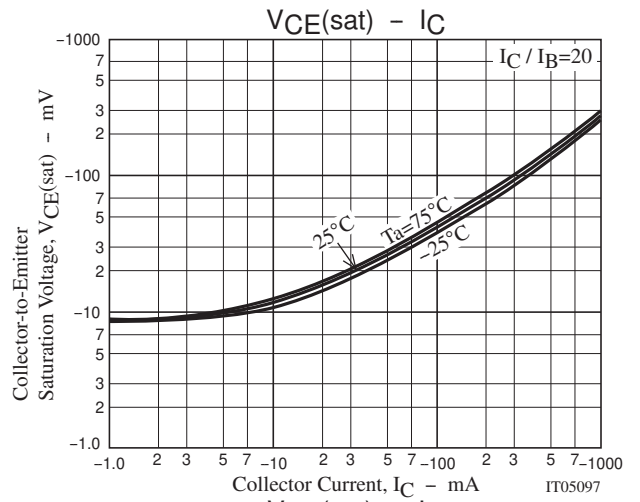
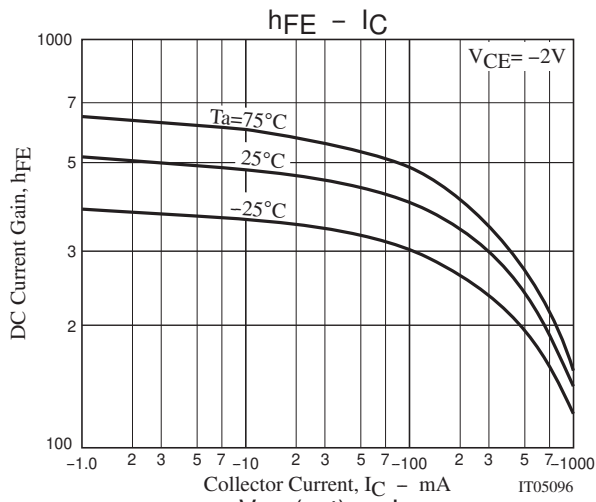

12A02MH

Embossed Taping Specification

12A02MH-TL-E

1. Packing Format

Package Name	Carrier Tape Type	Maximum Number of devices contained (pcs)			Packing format	
		Reel	Inner box	Outer box	Inner BOX (C-1)	Outer BOX (A-7)
MCPH3	MCPH3	3,000	15,000	90,000	5 reels contained Dimensions:mm (external) 183×72×185	6 inner boxes contained Dimensions:mm (external) 440×195×210

Packing method

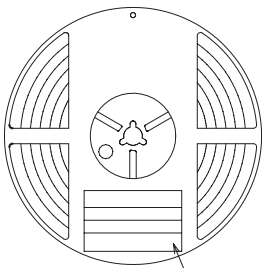

Reel label

Type No.
LOT No.
Quantity
Origin

Reel label, Inner box label
(unit:mm)

Outer box label

It is a label at the time of factory shipments.
The form of a label may change in physical distribution process.

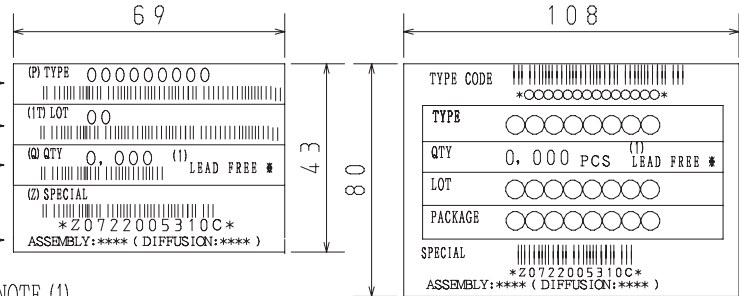

NOTE (1)

The LEAD FREE * description shows that the surface treatment of the terminal is lead free.

Label	JEITA Phase
LEAD FREE 3	JEITA Phase 3A
LEAD FREE 4	JEITA Phase 3

2. Taping configuration

2-1. Carrier tape size (unit:mm)

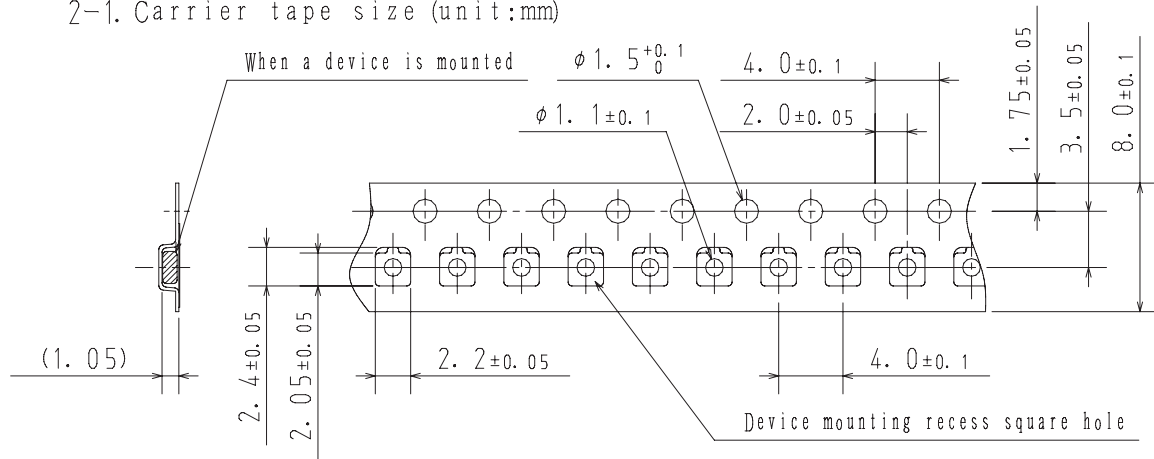

2-2. Device placement direction

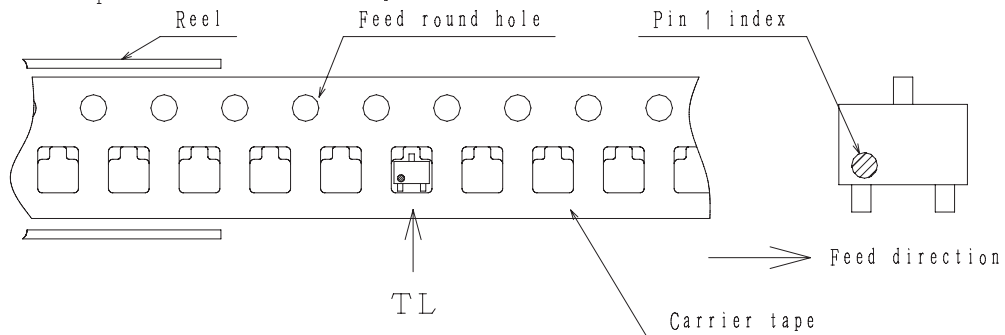

Those with pin 1 index on the feed hole side.....TL

12A02MH

Outline Drawing

12A02MH-TL-E

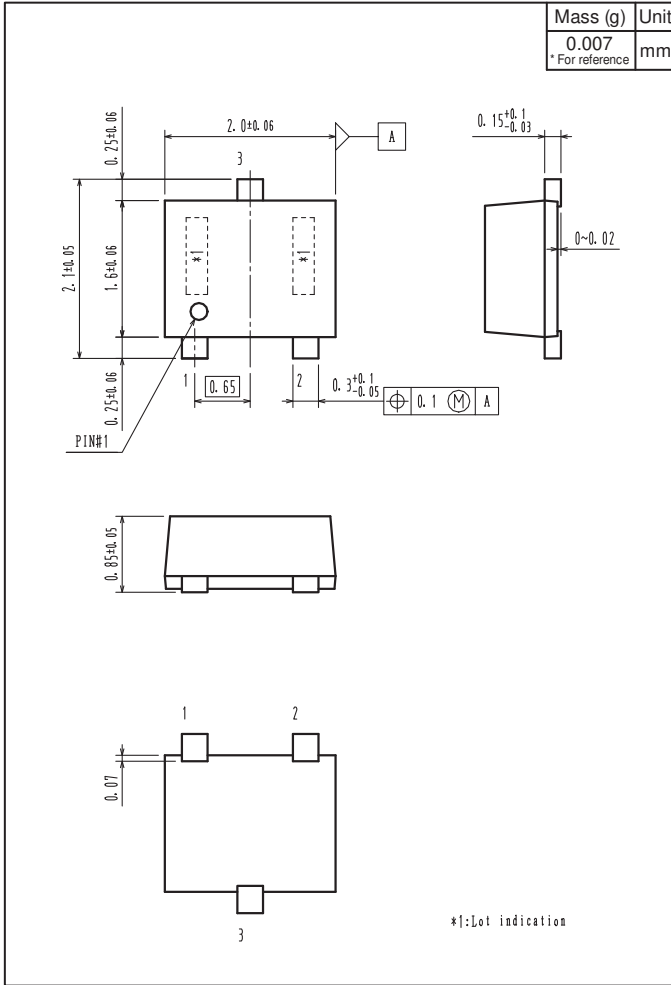

Land Pattern Example

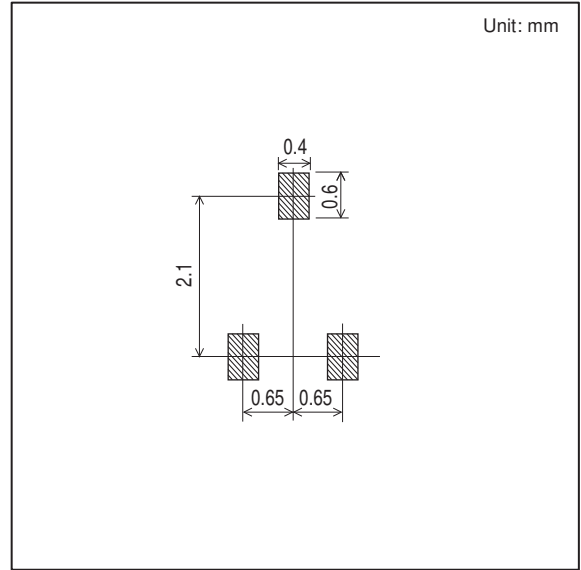

ON Semiconductor and the ON logo are registered trademarks of Semiconductor Components Industries, LLC (SCILLC). SCILLC owns the rights to a number of patents, trademarks, copyrights, trade secrets, and other intellectual property. A listing of SCILLC's product/patent coverage may be accessed at www.onsemi.com/site/pdf/Patent-Marking.pdf. SCILLC reserves the right to make changes without further notice to any products herein. SCILLC makes no warranty, representation or guarantee regarding the suitability of its products for any particular purpose, nor does SCILLC assume any liability arising out of the application or use of any product or circuit, and specifically disclaims any and all liability, including without limitation special, consequential or incidental damages. "Typical" parameters which may be provided in SCILLC data sheets and/or specifications can and do vary in different applications and actual performance may vary over time. All operating parameters, including "Typicals" must be validated for each customer application by customer's technical experts. SCILLC does not convey any license under its patent rights nor the rights of others. SCILLC products are not designed, intended, or authorized for use as components in systems intended for surgical implant into the body, or other applications intended to support or sustain life, or for any other application in which the failure of the SCILLC product could create a situation where personal injury or death may occur. Should Buyer purchase or use SCILLC products for any such unintended or unauthorized application, Buyer shall indemnify and hold SCILLC and its officers, employees, subsidiaries, affiliates, and distributors harmless against all claims, costs, damages, and expenses, and reasonable attorney fees arising out of, directly or indirectly, any claim of personal injury or death associated with such unintended or unauthorized use, even if such claim alleges that SCILLC was negligent regarding the design or manufacture of the part. SCILLC is an Equal Opportunity/Affirmative Action Employer. This literature is subject to all applicable copyright laws and is not for resale in any manner.