



Chipsmall Limited consists of a professional team with an average of over 10 year of expertise in the distribution of electronic components. Based in Hongkong, we have already established firm and mutual-benefit business relationships with customers from,Europe,America and south Asia,supplying obsolete and hard-to-find components to meet their specific needs.

With the principle of “Quality Parts,Customers Priority,Honest Operation,and Considerate Service”,our business mainly focus on the distribution of electronic components. Line cards we deal with include Microchip,ALPS,ROHM,Xilinx,Pulse,ON,Everlight and Freescale. Main products comprise IC,Modules,Potentiometer,IC Socket,Relay,Connector.Our parts cover such applications as commercial,industrial, and automotives areas.

We are looking forward to setting up business relationship with you and hope to provide you with the best service and solution. Let us make a better world for our industry!



Contact us

Tel: +86-755-8981 8866 Fax: +86-755-8427 6832

Email & Skype: info@chipsmall.com Web: www.chipsmall.com

Address: A1208, Overseas Decoration Building, #122 Zhenhua RD., Futian, Shenzhen, China



Aero-Motive®

balancers

and tool support



- Includes
- Positioners
- Retractors
- Balancers
- Torque Reels
- Workstation Assemblies
- Accessories

W | **Woodhead**

www.woodhead.com

Aero-Motive® Balancers Enhance Productivity

It's a simple fact. Make a job easier to do, and you can do it better, faster, longer. Balancers and tool support systems by Woodhead improve the productivity of light assembly, packaging, and many other shop floor workers by keeping their tools out of the way when not needed. With balancers, workstations can be organized more efficiently by ensuring that tools are always in the right place. Expensive power tools suspended from balancers are safeguarded from being accidentally dropped onto the floor or onto other expensive products or equipment.

Selection Guide

When selecting a balancer, be sure that all items to be supported are considered: tools, drill bits, sockets, hoses, cable, etc. This Selection Guide is to be used only as a reference for non-ratchet lock devices. See the main pages for ratchet balancer specs. Actual selection depends on weight to be balanced and cable travel required.

Page Guide

Positioner.	4
Retractors	4-7
Balancers.	7-13
Torque Reels & Grounding Reels	14
Accessories.	15-18
Cable Support Grips	19
Workstation Assemblies	20-23
Technical Drawings	24-27



Always use a secondary support on overhead-mounted balancers to prevent the possibility of the balancer accidentally falling. See page 15 to select a secondary support chain.



Tool Positioner

model	weight range (kg)	travel (m)	weight range (lb)	travel (ft)
GM31	0.5 - 5.4	1.4	1.0 - 10.0	4.7

Retractors

model	weight range (kg)	travel (m)	weight range (lb)	travel (ft)
RB2	0.5 - 0.9	2.0	1.0 - 2.0	6.6
RB4	0.9 - 1.8	2.0	2.0 - 4.0	6.6
RF6	1.8 - 2.7	2.0	4.0 - 6.0	6.6
RF8	2.7 - 3.6	2.0	6.0 - 8.0	6.6
5F	0.4 - 2.3	2.4	1.0 - 5.0	8.0
10F	1.8 - 4.5	2.4	4.0 - 10.0	8.0
15F	3.6 - 6.8	2.4	8.0 - 15.0	8.0
22F	7.3 - 10.0	2.4	16.0 - 22.0	8.0

Balancers

model	weight range (kg)	travel (m)	weight range (lb)	travel (ft)
BF6	1.4 - 2.7	2.0	3.0 - 6.0	6.6
BF9	2.7 - 4.1	2.0	6.0 - 9.0	6.6
BF13	4.1 - 5.9	2.0	9.0 - 13.0	6.6
BF18	5.9 - 8.2	2.0	13.0 - 18.0	6.6
BF24	8.2 - 10.9	2.0	18.0 - 24.0	6.6
EB25000	8.2 - 11.4	2.0	18.0 - 25.0	6.6
EB35000	11.4 - 15.9	2.0	25.0 - 35.0	6.6
EB45000	15.9 - 20.5	2.0	35.0 - 45.0	6.6
EB48S00	15.9 - 21.8	1.5	35.0 - 48.0	4.9
EB60S00	20.5 - 27.3	1.5	45.0 - 60.0	4.9
10EA	2.3 - 5.0	1.8	5.0 - 11.0	6.0
20EA	5.0 - 9.0	1.8	11.0 - 20.0	6.0
30EA	9.0 - 14.0	1.8	20.0 - 31.0	6.0
40EA	13.0 - 18.0	1.8	29.0 - 40.0	6.0
20JA	6.0 - 11.0	2.1	13.0 - 25.0	7.0
30JA	11.0 - 16.0	2.1	24.0 - 35.0	7.0
40JA	13.0 - 20.0	2.1	29.0 - 45.0	7.0
50JA	18.0 - 25.0	2.1	40.0 - 55.0	7.0
70JA	24.0 - 32.0	2.1	53.0 - 70.0	7.0
80JA	31.0 - 39.0	2.1	68.0 - 86.0	7.0
90JA	36.0 - 41.0	2.1	79.0 - 90.0	7.0
100JA	40.0 - 45.0	2.1	88.0 - 100.0	7.0
110KA	38.0 - 52.0	2.1	84.0 - 115.0	7.0
120KA	52.0 - 57.0	2.1	115.0 - 126.0	7.0
134KA	56.0 - 66.0	2.1	124.0 - 146.0	7.0
156KA	65.0 - 75.0	2.1	143.0 - 165.0	7.0
170KA	72.0 - 79.0	2.1	159.0 - 175.0	7.0
192KA	79.0 - 91.0	2.1	174.0 - 200.0	7.0
220KA	91.0 - 100.0	1.8	200.0 - 221.0	6.0
240KA	100.0 - 110.0	1.8	221.0 - 243.0	6.0
210LA	79.0 - 95.0	2.1	174.0 - 210.0	7.0
230LA	95.0 - 107.0	2.1	209.0 - 236.0	7.0
250LA	106.0 - 113.0	2.1	234.0 - 250.0	7.0
260LA	113.0 - 120.0	2.1	249.0 - 265.0	7.0
280LA	120.0 - 127.0	2.1	265.0 - 280.0	7.0
290LA	127.0 - 132.0	2.1	280.0 - 291.0	7.0
300LA	131.0 - 136.0	2.1	289.0 - 300.0	7.0
330LA	136.0 - 150.0	1.5	300.0 - 331.0	5.0
350LA	150.0 - 159.0	1.5	330.0 - 350.0	5.0
370LA	163.0 - 168.0	1.5	350.0 - 370.0	5.0

Positioner

- Supports weight mid-stroke
- Must lift tool to upper position
- Support up to 4.5 kg/10 lb

Positioners use an adjustable friction brake to support the weight of the suspended tool or object. The object can be placed in any position within the cable travel range and it will remain in that position. The object can be moved downward with very little effort, depending on the adjustment; however, the full weight of the object must be lifted to move it upward.

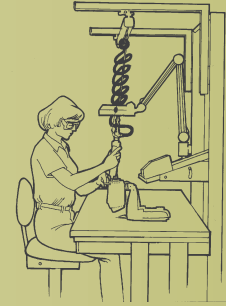

Retractors

- Retracts tools to upper position
- Light force to hold mid-stroke
- Retract up to 10 kg/22 lb

Retractors are designed to retract the cable when no force is applied. An amount of downward force must be continually applied to keep the suspended object at its extended position. The torque output of the rewind spring increases as the cable is extended, retracting the suspended object to the uppermost adjusted position when released.

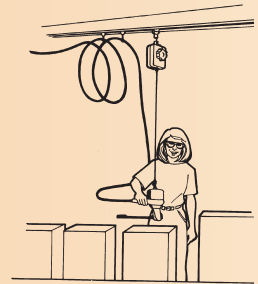

Balancers

- Balances tool in any position
- Very little effort to move tool
- Balance up to 168 kg/370 lb

Balancers allow the worker to move the suspended tool or object up or down with very little effort. Depending on the spring adjustment, object will remain in position or retract when no force is applied. With a spiral groove on a tapered drum, the winding radius is increased to match the torque buildup of the spring, thus neutralizing it and achieving a balance condition.

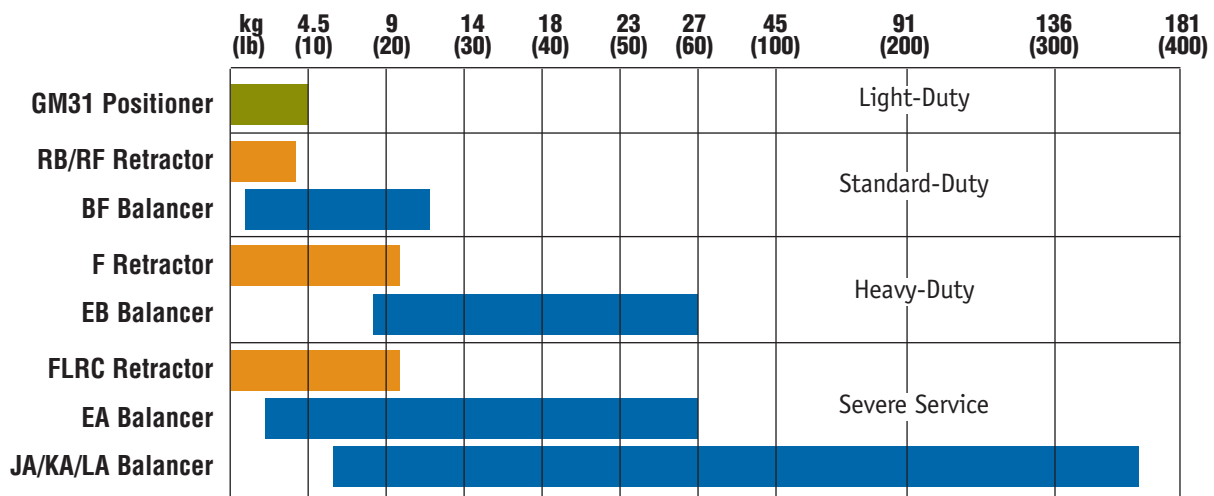
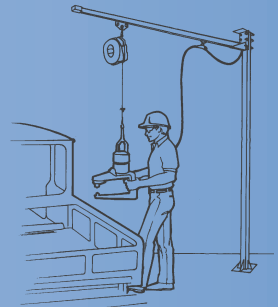

POSITIONER

GM	0.5 - 4.5 kg
1.0 - 10.0 lb	TOOL POSITIONER



- Holds an object in desired position within travel range without use of a ratchet or locking device
- Easy downward tool mobility
- Simple upward repositioning of load, requiring only a force equal to the weight of the suspended object
- Minimizes operator fatigue in repetitive-motion applications with light loads
- Easy tension adjustment by placing screwdriver or coin into slot of shaft.
- For light duty use

Accessory Tool Clip (only)
Model #01146P0015



Tool Positioner

model	weight range (kg)	travel (m)	weight range (lb)	travel (ft)
GM31	0.5 - 4.5	1.4	1.0 - 10.0	4.7

See page 24 for dimensions

RB	0.5 - 1.8 kg
1.0 - 4.0 lb	RETRACTORS

- Heavy-duty, long-life spring for lasting performance
- Easy tension adjustment with no tools required
- Full range of motion with 360° swivel hanger
- Quick installation
- Durable nylon cord for long life and reduced maintenance
- Convenient snap-type tool clip for easy tool handling
- Alignment of hanger and tool hook for smooth, efficient use

See page 24 for dimensions

RB Retractors

model	weight range (kg)	travel (m)	weight range (lb)	travel (ft)
RB2	0.0 - 0.9	2.0	0.0 - 2.0	6.6
RB4	0.9 - 1.8	2.0	2.0 - 4.0	6.6
RB210	0.5 - 0.9	2.54	1.0 - 2.0	10.0



RF	1.8 - 3.6 kg
4.0 - 8.0 lb	RETRACTORS

- Heavy-duty, long-life spring for lasting performance
- Easy tension adjustment with no tools required
- 360° forged steel swivel hanger for full range of motion
- Quick installation
- Durable nylon-covered steel cable for consistent service & easy maintenance
- Alignment of hanger and tool hook for smooth, efficient use
- Simplified tool attachment and removal with convenient snap-type tool clip
- Ratchet lock available (RFL models) for free movement when required

RF Retractors

model	weight range (kg)	travel (m)	weight range (lb)	travel (ft)
RF6	1.8 - 2.7	2.0	4.0 - 6.0	6.6
RF8	2.7 - 3.6	2.0	6.0 - 8.0	6.6

RFL Retractors with Ratchet Locks

model	weight range (kg)	travel (m)	weight range (lb)	travel (ft)
RFL6	1.8 - 2.7	2.0	4.0 - 6.0	6.6
RFL8	2.7 - 3.6	2.0	6.0 - 8.0	6.6



See page 24 for dimensions

RETRACTORS

F	0.4 - 10.0 kg
1.0 - 22.0 lb	RETRACTORS

- Easy tension adjustment with no special tools required
- Heavy-duty steel construction for long life
- Long-lasting mainspring designed to minimize spring flexing and fatigue
- Tool can be set at desired position with adjustable cable stop
- Durable 3/32"-diameter stranded steel aircraft cable
- Ratchet lock (on FLR models) locks out retraction tension for unrestricted tool movement (ON/OFF switchable)

F Retractors

model	weight range (kg)	travel (m)	weight range (lb)	travel (ft)
5F	0.4 - 2.3	2.4	1.0 - 5.0	8.0
10F	1.8 - 4.5	2.4	4.0 - 10.0	8.0
15F	3.6 - 6.8	2.4	8.0 - 15.0	8.0
22F	7.3 - 10.0	2.4	16.0 - 22.0	8.0

FLR Retractors with Ratchet Locks

model	weight range (kg)	travel (m)	weight range (lb)	travel (ft)
5FLR	0.4 - 2.3	2.4	1.0 - 5.0	8.0
10FLR	1.8 - 4.5	2.4	4.0 - 10.0	8.0
15FLR	3.6 - 6.8	2.4	8.0 - 15.0	8.0
22FLR	7.3 - 10.0	2.4	16.0 - 22.0	8.0



See page 24 for dimensions

FLRC	0.8 - 10.0 kg
2.0 - 22.0 lb	CAST ALUMINUM RETRACTOR



See page 25 for dimensions

- Durable heavy-walled cast aluminum housing ensures long life
- Recessed tension adjustment knobs minimize damage from rough use
- 360° swivel design maintains balancer and tool alignment and minimizes wear
- Forged-steel mounting shackle ensures safe operation
- Standard ratchet lock allows cable locking at desired position and can be turned off if desired
- 3/32" diameter stranded galvanized steel cable

FLRC Retractor with Ratchet Locks

model	weight range (kg)	travel (m)	weight range (lb)	travel (ft)
5FLRC	0.8 - 3.2	2.4	2.0 - 7.0	8.0
10FLRC	1.8 - 4.5	2.4	4.0 - 10.0	8.0
15FLRC	3.6 - 6.8	2.4	8.0 - 15.0	8.0
22FLRC	7.3 - 10.0	2.4	16.0 - 22.0	8.0

Make tools
virtually
weightless
for faster,
safer
production

Aero-Motive® balancers suspend tools where they are easy to reach and use. They allow workers to move faster with less risk of fatigue and repetitive motion stress. They also help prevent tools from being misplaced or damaged.

True precision for optimum productivity Many balancers on the market promise “zero gravity” but deliver only within a narrow segment of their range. TrueBalancers always live up to their name. That is why we offer hundreds of choices ranging from 1.4 to 168 kg (3 to 370 lb) capacity. Advances such as high-impact housings, spiral-grooved tapered drums, manual drum locks and replaceable spring assemblies, ensure long-term performance and value.

Safer & easier to use Redundant safety features are built into every balancer. Simple tension adjustment and easy cable replacement also help make Aero-Motive balancers from Woodhead leaders in safety and convenience.



SAFETY/CONVENIENCE

- Steel shackle
- 360° rotation

SAFETY

- Manual drum lock for easy, safe cable change

MINIMUM EFFORT OF MOVEMENT

- Tapered drum matches spring mid-range for constant torque and maximum spring life.

SAFETY

- Automatic drum lock prevents load from falling in the event of a spring failure

EASY INSTALLATION/ MAINTENANCE

- External tension adjustment

SAFETY

- Swaged cable assembly for maximum flexibility

WIDE WEIGHT RANGE

- Simple spring adjustment
- Easily interchangeable spring assemblies

BF shown
(Some features listed not available on BF)

BALANCERS

BF	1.4 - 10.9 kg
3.0 - 24.0 lb	BALANCERS

- Heavy-duty, long-life spring for lasting performance
- Automatic lock prevents load from falling if spring loses tension
- Snap-type tool clip for simplified attachment and removal
- Forged steel 360° swivel hanger
- High-impact composite housing for extra durability
- Ratchet lock (on BFL models) holds cable at desired position
- Shackle design instead of hook and spring clip provides extra-secure mounting
- 3/32" diameter stranded galvanized steel cable

BF Balancers

model	weight range (kg)	travel (m)	weight range (lb)	travel (ft)
BF6	1.4 - 2.7	2.0	3.0 - 6.0	6.6
BF9	2.7 - 4.1	2.0	6.0 - 9.0	6.6
BF13	4.1 - 5.9	2.0	9.0 - 13.0	6.6
BF18	5.9 - 8.2	2.0	13.0 - 18.0	6.6
BF24	8.2 - 10.9	2.0	18.0 - 24.0	6.6

BFL Balancers with Ratchet Locks

model	weight range (kg)	travel (m)	weight range (lb)	travel (ft)
BFL6	1.4 - 2.7	2.0	3.0 - 6.0	6.6
BFL9	2.7 - 4.1	2.0	6.0 - 9.0	6.6
BFL13	4.1 - 5.9	2.0	9.0 - 13.0	6.6
BFL18	5.9 - 8.2	2.0	13.0 - 18.0	6.6
BFL24	8.2 - 10.9	2.0	18.0 - 24.0	6.6



See page 25 for dimensions

EB

8.2 - 27.3 kg

18.0 - 60.0 lb

BALANCERS**BALANCERS**

See pages 15-16 for options
See page 25 for dimensions

- Cast aluminum construction
- Containerized mainspring for safe, easy spring handling
- Automatic drum lock secures load even if tension drops suddenly
- Manual drum lock for easy tool replacement
- Full range of motion with 360° swivel hanger
- Easy external adjustment with no special tools
- Swaged steel cable assembly
- Easy cable replacement without disassembly
- Extra-secure mounting with a shackle design, as opposed to hook and spring clip, which can disengage on impact
- Ratchet lock version (EB/R) holds cable at desired position
- Locking gate hook option available
- 1/8" diameter stranded galvanized steel cable

EB Balancers

model	weight range (kg)	travel (m)	weight range (lb)	travel (ft)
EB25000	8.2 – 11.4	2.0	18.0 – 25.0	6.6
EB35000	11.4 – 15.9	2.0	25.0 – 35.0	6.6
EB45000	15.9 – 20.5	2.0	35.0 – 45.0	6.6
EB48S00	15.9 – 21.8	1.5	35.0 – 48.0	4.9
EB60S00	20.5 – 27.3	1.5	45.0 – 60.0	4.9

EB/R Balancers with Ratchet Locks

model	weight range (kg)	travel (m)	weight range (lb)	travel (ft)
EB2500R	8.2 – 11.4	2.0	18.0 – 25.0	6.6
EB3500R	11.4 – 15.9	2.0	25.0 – 35.0	6.6
EB4500R	15.9 – 20.5	2.0	35.0 – 45.0	6.6
EB48SOR	15.9 – 21.8	1.5	35.0 – 48.0	4.9
EB60SOR	20.5 – 27.3	1.5	45.0 – 60.0	4.9

BALANCERS

EA	2.3 - 28.0 kg
5.0 - 62.0 lb	BALANCERS

- Tapered drum minimizes tension buildup
- Wear-Guard® coated drum protects cable
- Automatic drum lock secures load even if tension drops
- 1/8" diameter stranded galvanized steel cable
- Manual drum lock for easy tool replacement
- Containerized mainspring for safe, easy spring handling
- Declutching hub prevents spring damage

EA Balancers with heavy cast aluminum housing and cover

model	weight range (kg)	travel (m)	weight range (lb)	travel (ft)
10EA	2.3 - 5.0	1.8	5.0 - 11.0	6.0
20EA	5.0 - 9.0	1.8	11.0 - 20.0	6.0
30EA	9.0 - 14.0	1.8	20.0 - 31.0	6.0
40EA	13.0 - 18.0	1.8	29.0 - 40.0	6.0
50EA	18.0 - 23.0	1.8	40.0 - 51.0	6.0
60EA	23.0 - 28.0	1.8	51.0 - 62.0	6.0



See pages 15-16 for options
See page 26 for dimensions

EL	5.0 - 18.1 kg
11.0 - 40.0 lb	BALANCERS



See pages 15-16 for options
See page 26 for dimensions

- Cast aluminum housing and cover provide added strength
- Tapered drum minimizes tension buildup
- Wear-Guard coated drum protects cable
- Automatic drum lock secures load even if tension drops
- Manual drum lock for easy tool replacement
- Containerized mainspring for safe, easy spring handling
- Declutching hub prevents spring damage
- Standard ratchet lock
- 1/8" diameter stranded galvanized steel cable
- On/Off switchable ratchet lock

EL Balancers with Ratchet Locks

model	weight range (kg)	travel (m)	weight range (lb)	travel (ft)
25EL	5.0 - 11.3	1.8	11.0 - 25.0	6.0
40EL	11.8 - 18.1	1.8	26.0 - 40.0	6.0

JA	4.0 - 45.0 kg
10.0 - 100.0 lb	BALANCERS

- Wear-Guard® coated drum protects cable and prevents premature failure
- Quick, easy tool changes with manual drum lock
- Automatic drum lock secures load even if tension drops
- Containerized mainspring for safe, easy handling
- Easy external adjustment with no special tools
- Full range of motion with 360° swivel hanger
- Declutching hub prevents spring damage
- Shackle design provides extra-secure mounting
- Constructed from high tensile strength cast aluminum
- 3/16" diameter stranded galvanized steel cable

JA Balancers

model	weight range (kg)	travel (m)	weight range (lb)	travel (ft)
20JA	6.0 – 11.0	2.1	13.0 – 25.0	7.0
30JA	11.0 – 16.0	2.1	24.0 – 35.0	7.0
40JA	13.0 – 20.0	2.1	29.0 – 45.0	7.0
50JA	18.0 – 25.0	2.1	40.0 – 55.0	7.0
70JA	24.0 – 32.0	2.1	53.0 – 70.0	7.0
80JA	31.0 – 39.0	2.1	68.0 – 86.0	7.0
90JA	36.0 – 41.0	2.1	79.0 – 90.0	7.0
100JA	40.0 – 45.0	2.1	88.0 – 100.0	7.0

*JA Balancers with Extended Cable Travel**

model	weight range (kg)	travel (m)	weight range (lb)	travel (ft)
9020JA	4.0 – 9.0	2.7	10.0 – 20.0	9.0
9030JA	9.0 – 14.0	2.7	20.0 – 30.0	9.0
9040JA	13.0 – 18.0	2.7	30.0 – 40.0	9.0
9050JA	18.0 – 23.0	2.7	40.0 – 50.0	9.0
9060JA	to – 29.0	2.7	to – 65.0	9.0
9070JA	to – 33.0	2.7	to – 72.0	9.0

*Longer lead times may apply.



See pages 15-16 for options
See page 26 for dimensions

BALANCERS

BALANCERS

KA	36.0 - 110.0 kg
80.0 - 243.0 lb	BALANCERS

- Premature failure is prevented by a Wear-Guard® coating on the drum and a four-roller guide, which protect the cable and drum from excessive wear
- Quick, easy tool changes with manual drum lock
- Automatic drum lock secures load even if tension drops
- Safe, easy spring handling is ensured with heavy-duty containerized mainspring
- Easy external adjustment with no special tools
- Full range of motion with 360° swivel hanger
- Spring damage prevented by declutching hub, even if spring is reverse wound
- Shackle design provides extra-secure mounting
- Cast aluminum construction for long life
- Extra durable cast aluminum housing
- 3/16" diameter stranded galvanized steel cable

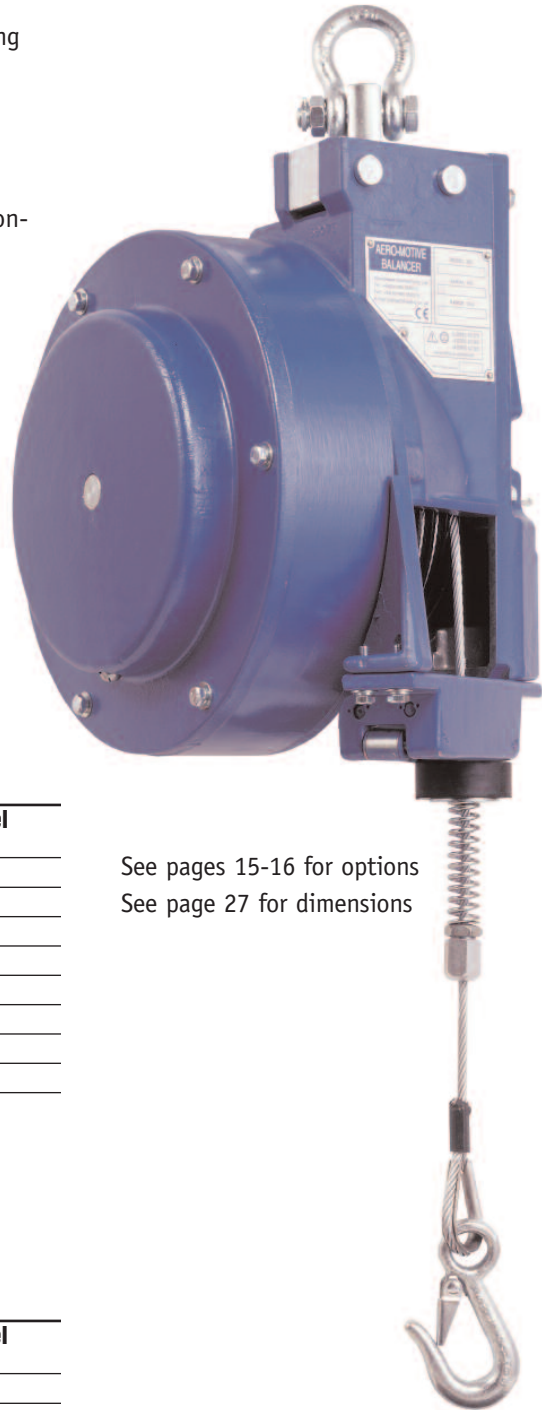

See pages 15-16 for options
See page 27 for dimensions

KA Balancers

model	weight range (kg)	travel (m)	weight range (lb)	travel (ft)
110KA	38.0 - 52.0	2.1	84.0 - 115.0	7.0
120KA	52.0 - 57.0	2.1	115.0 - 126.0	7.0
134KA	56.0 - 66.0	2.1	124.0 - 146.0	7.0
156KA	65.0 - 75.0	2.1	143.0 - 165.0	7.0
170KA	72.0 - 79.0	2.1	159.0 - 175.0	7.0
192KA	79.0 - 91.0	2.1	174.0 - 200.0	7.0
220KA	91.0 - 100.0	1.8	200.0 - 221.0	6.0
240KA	100.0 - 110.0	1.8	221.0 - 243.0	6.0

KA Balancers with Extended Cable Travel*

model	weight range (kg)	travel (m)	weight range (lb)	travel (ft)
9110KA	36.0 - 50.0	2.7	80.0 - 110.0	9.0
9120KA	52.0 - 57.0	2.7	115.0 - 125.0	9.0
9140KA	56.0 - 58.0	2.7	125.0 - 130.0	9.0
9150KA	to - 66.0	2.7	to - 145.0	9.0

*Longer lead times may apply.

LA	70.0 - 168.0 kg
155.0 - 370.0 lb	BALANCERS

- Premature failure is prevented by a Wear-Guard® coating on the drum and a four-roller guide, which protect the cable and drum from excessive wear
- Quick, easy tool changes with manual drum lock
- Automatic lock secures load if tension drops
- Caged mainspring for safe, easy spring handling
- Easy external adjustment with no special tools
- Full range of motion with 360° swivel hanger
- Declutching hub prevents spring damage, even if spring is reverse wound
- Cast aluminum construction for long life
- High tensile strength
- 3/16" cable diameter



BALANCERS

LA Balancers

model	weight range (kg)	travel (m)	weight range (lb)	travel (ft)
210LA	79.0 – 95.0	2.1	174.0 – 210.0	7.0
230LA	95.0 – 107.0	2.1	209.0 – 236.0	7.0
250LA	106.0 – 113.0	2.1	234.0 – 250.0	7.0
260LA	113.0 – 120.0	2.1	249.0 – 265.0	7.0
280LA	120.0 – 127.0	2.1	265.0 – 280.0	7.0
290LA	127.0 – 132.0	2.1	280.0 – 291.0	7.0
300LA	131.0 – 136.0	2.1	289.0 – 300.0	7.0
330LAS	136.0 – 150.0	1.5	300.0 – 331.0	5.0
350LAS	150.0 – 159.0	1.5	330.0 – 350.0	5.0
370LAS	163.0 – 168.0	1.5	350.0 – 370.0	5.0

See pages 15-16 for options
See page 27 for dimensions

LA Balancers with Extended Cable Travel*

model	weight range (kg)	travel (m)	weight range (lb)	travel (ft)
9160LA	70.0 – 75.0	2.7	155.0 – 165.0	9.0
9198LA	85.0 – 90.0	2.7	188.0 – 198.0	9.0
9200LA	81.0 – 86.0	2.7	180.0 – 190.0	9.0
9210LA	90.0 – 95.0	2.7	200.0 – 210.0	9.0
9230LA	95.0 – 98.0	2.7	210.0 – 215.0	9.0

*Longer lead times may apply.

1 5 1 5 T

2.3 - 6.8 kg

5.0 - 15.0 lb

TORQUE REELS



Torque reels are reeling devices primarily designed for suspending push-button pendant stations weighing up to 15 lbs. A lock mechanism permits the operator to stop a load at a desired height, while a slight pull on the cable releases the lock.

1515TR Rigid Mount Torque Reel



1515T Hanging Torque Reel



- Easy load height adjustment; a slight pull on the cable releases the lock
- Features an Off switch to disengage locking mechanism when constant tension is required
- Easy external tension adjustment
- Adjustable cable stop, snap hook, multi-directional guide, forged clevis top mount, and 15 feet of cable
- Rigid mount included on model 1515TR
- 3/32" diameter stranded galvanized steel cable

See page 27 for dimensions

Torque Reels

model	weight (kg)	travel (m)	tension buildup(kg)	weight (lb)	travel (ft)	tension buildup(lb)
0515T	2.3	1.58	3.20	5.0	15.0	7.0
1015T	4.5	1.58	5.50	10.0	15.0	12.0
1515T	6.8	4.58	8.64	15.0	15.0	19.0
1515TR	6.8	4.58	8.64	15.0	15.0	19.0

STATIC DISCHARGE GROUNDING REELS

ELIMINATES STATIC BUILD-UP. SPRING-OPERATED, AUTOMATIC RETRIEVAL.



- Spring operated, automatic retrieve reel
- Stranded steel aircraft cable is 3/32".
- Provides light, constant spring tension on the cable
- 100 ampere ground clamp
- Rubber cable stop
- 2050Y Reel with a "Y" bridle allows two ground connections at the same time, providing maximum efficiency.

Static Discharge Grounding Reels

Model	Cable length		Net weight		Resistance ohms
	m	ft	kg	lb	
2050	15.24	50	5.44	12	2.0
2050Y*	15.24	50	5.44	12	2.0
2050NC	15.24	50	5.44	12	2.0
2050CT	15.24	50	5.44	12	2.0
2050NCCT	15.24	50	5.44	12	2.0

"NC" = nylon coated cable 3/32"

"CT" = constant tension models.

*2050Y Reel with "Y" Bridle (30 ft. payout then 20 ft. bridle for each branch, with clamps) allows simultaneous grounding at two points.

OVERHANG CABLE 0.9 - 10.6 Meters
3.0 - 35.0 Feet

Overhang Cable for RB, RF, BF, F & FLRC (Fixed length)

model	Length (m)	Length (ft)
CBOF009	0.9	3.0
CBOF015	1.5	5.0
CBOF030	3.0	10.0
CBOF045	4.5	15.0
CBOF060	6.0	20.0
CBOF076	7.6	25.0
CBOF091	9.1	30.0
CBOF106	10.6	35.0

- Provides additional length by attaching to retractable cable supplied with balancer
- Allows balancer to be mounted at a higher elevation
- ★ DOES NOT RETRACT INTO HOUSING

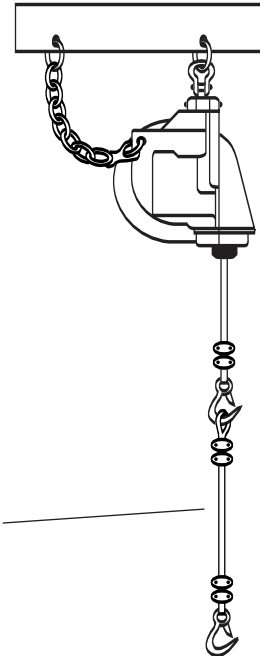

Overhang Cable for EA, EB, JA, KA & LA (Adjustable w/ clamps)

model	Length (m)	Length (ft)
CBOL020	2.0	6.5
CBOL050	5.0	16.4
CBOL100	10.0	32.8

Overhang Cable

SECONDARY SUPPORT CHAINS AND CABLE
FOR BALANCERS AND TORQUE REELS



- Provides additional safety by preventing balancer from accidentally falling due to failure of the support structure
- Chain or cable attaches to the balancer and to a support other than the balancer support

The length of the chain or cable should be kept to an absolute minimum and may need to be adjusted.

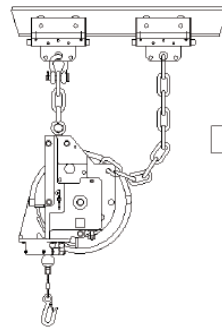

Trolley Mount

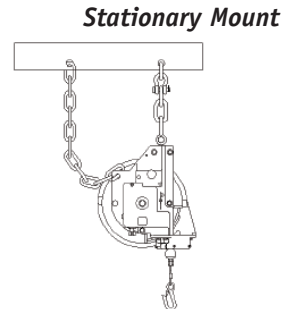

Stationary Mount



*Support Chain**

model	Length (mm)	Length (in)	Description
SSPLC	483	19	for EA, JA, KA & LA
SSPEC	508	20	for EB, F, FLRC & 1515T

*Support Wire Cable**

model	Length (mm)	Length (in)	Description
SSPBR	508	20	for RF & BF
SSPRR	388	15.25	for RB

*To omit support device from balancer, add suffix "D" to model number. Suffixes are added in alphabetical order. A price reduction may apply.

SPECIAL CABLE HOOK OPTIONS

FOR E, JA, KA AND LA

Field Kits / Replacement Parts for Balancers

Upper Hook Assembly

Model	Description
UHKEB	Bullard Type for EA
UHKKB	Bullard Type for JA, KA
UHKLB	Bullard Type for LA (2.1m/7ft)
UHK9B	Bullard Type for LA (2.7m/9ft)
UHKES	Shackle Type for EA
UHKKS	Shackle Type for JA, KA
UHKLS	Shackle Type for LA (2.1m/7ft)
UHK9S	Shackle Type for LA (2.7m/9ft)

Cable & Lower Hook







Model	Description
CBAEB	Bullard Type for EA
CBAEBL	Bullard Type for EL
CBALB7	Bullard Type for JA, KA, LA (2.1m/7ft)
CBALB9	Bullard Type for JA, KA, LA (2.7m/9ft)
CBAET	Tool Clip Type for EA
CBAETL	Tool Clip Type for EL
CBALT7	Tool Clip Type for JA, KA, LA (2.1m/7ft)
CBALT9	Tool Clip Type for JA, KA, LA (2.7m/9ft)

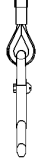

- Bullard hooks and clamp and insulator options are available to upgrade standard hook configurations.
- EA, EB, JA, KA and LA come standard with upper shackle and tool clip.
- All Bullard hook options have a locking gate

Hook Upgrade

To upgrade hooks, find desired option in chart below, and add suffixes to model number in alphabetical order. Example: 80JABU = balancer with upper Bullard and bottom Bullard Hooks.

Upper Hook Assembly	 Upper Shackle				 Upper Mercedes Hook	 Upper Bullard Hook
Bottom Hook Assembly	 Bottom Tool Clip	 Bottom Bullard Hook	 Bottom Clamps	 Bottom Insulator		
EA	Standard	B	C	I	M	U
EB	Standard	B		I	M	U
JA, KA	Standard	B	C	I	M	U
LA	Standard	B	C	I	M	U



Shackle Hook



Bullard Hook



BT3	0.0 - 136.0 kg
0.0 - 300.0 lb	TROLLEYS

- Quiet operation & long-lasting performance, with polyurethane wheels on either 4" I-beam or 3¼" patented rail
- Insulated trolleys are safeguarded from electrical charges, with suspended load electrically insulated from the support beam above

BT5	0.0 - 227.0 kg
0.0 - 500.0 lb	TROLLEYS

- High-speed design with steel wheels & presealed high-speed bearings
- Available for 4" I-beam or 3¼" patented rail

Model	Description	Wheels
BT34I	Trolley for 4" I-Beam	Polyurethane
BT3PR	Trolley for 3¼" Patented Rail	Polyurethane
BT34IW	Insulated Trolley for 4" I-Beam	Polyurethane
BT3PRW	Insulated Trolley for 3¼" Patented Rail	Polyurethane
BT54I	Trolley for 4" I-Beam	Steel
BT5PR	Trolley for 3¼" Patented Rail	Steel

See page 23 for dimensions



BALANCER TROLLEY FOR USE WITH OVERHEAD TRACK

- 0541100012 is compatible with 5400 tracks and 0521100012 is compatible with 5200 tracks
- 5400- max. 22 Kg (50lb) capacity
5200- max. 13 Kg (30lb) capacity

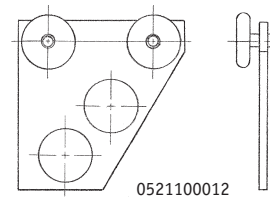

See page 22-23 for track selection.











HOSE AND CABLE SUPPORTS FOR 12.5mm - 32mm (0.49" - 1.25") DIAMETER

- Increases worker safety by keeping hoses/cables out of the way
- Increases hose/cable life and efficiency
- Allows easy access to hose/cable when needed
- Works well with Aero-Motive® balancers and torque reels featuring ratchet lock

Model	Hose / Cable Diameter
610200000	12.5mm - 23mm (0.49"-0.91")
610210000	23mm - 32mm (0.91"-1.25")

Hose support adapts to GM31, RB, BF and FLRC Balancer, and No. 1515T Torque Reel only.

BALANCER SERVICE KITS						
FOR EA, EB, JA, KA AND LA						
Model	Description					
CBGE	Cable Guide Assy for EA Balancers	 <p>CBG Cable Guide</p>				
CBGK	Cable Guide Assy for JA, KA Balancers					
CBGL	Cable Guide Assy for LA Balancers					
STAL7	Star Wheel Kit /Cable Length 7 ft(std) for JA, KA, LA Balancers	 <p>STAL Star Wheel Kit</p>				
STAL9	Star Wheel Kit /Cable Length 9 ft(extd) for JA, KA, LA Balancers					
DLKE	Drum Lock Kit for EA Balancers					
DLKK	Drum Lock Kit for JA, KA, EB Balancers	 <p>DRM Drum Kit</p>				
DLKL	Drum Lock Kit for LA Balancers					
DRME7	Drum Kit for EA Balancers (2.1m/7ft)					
DRMK7	Drum Kit for JA, KA Balancers (2.1m/7ft)					
DRMK9	Drum Kit for JA, KA Balancers (2.7m/9ft)					
DRML7	Drum Kit for LA Balancers (2.1m/7ft)					
DRML9	Drum Kit for LA Balancers (2.7m/9ft)					
SHFE	Shaft Kit for EA Balancers					
SHFJ	Shaft Kit for JA Balancers					
SHFK	Shaft Kit for KA Balancers					
SHFL	Shaft Kit for LA Balancers					
WRME	Worm Gear Kit for EA Balancers					
WRMJ	Worm Gear Kit for JA, KA Balancers					
WRML	Worm Gear Kit for LA Balancers					
DSLK	Drop Stop Lever Kit for JA, KA, Balancers					
DSAEA	Drop Stop Actuator Kit for EA					
DSAJA	Drop Stop Actuator Kit for 20JA/9020JA					
DSAJB	Drop Stop Actuator Kit for 30-60JA/9030-60JA					
DSAJC	Drop Stop Actuator Kit for 70-100JA/9070JA					
DSAKA	Drop Stop Actuator Kit for 110-130KA/9110-20KA					
DSAKB	Drop Stop Actuator Kit for 140-160KA/9140-50KA					
DSAKC	Drop Stop Actuator Kit for 170-200KA					
 <p>WRM Worm Gear Kit</p>		 <p>SHF Shaft Kit</p>		 <p>DLK Drum Lock Kit</p>	 <p>DSL Drop Stop Lever Kit</p>	 <p>DSA Drop Stop Actuator Kit</p>

Note: Photos on this page are representative. Included parts may vary by model.

BALANCER SPRING ASSEMBLY KITS

FOR E, EL, JA, KA AND LA

Balancer	Spring Assembly	Balancer	Outer Spring	Inner Spring	Balancer	Spring Assembly
10E	4191200000	110KA/9110KA	3127600110	3127700110	210LA	3139800008
20E	3165900020	120KA/9120KA	3127600120	3127700120	230LA/9230LA	3139800009
30E	3165900030	130KA-140KA/9030-40KA	3127600140	3127700140	250LA	3139800013
40E	3165900040	150KA-160KA/9150-60KA	3127600160	3127700160	260LA	3139800010
50E	3165900050	170KA	3127600170	3127700170	280LA	3139800010
60E	3165900060	190KA	3127600190	3127700190	290LA	3139800011
25EL	4191000000	192KA & 200KA	3127600200	3127700200	300LA	3139800015
40EL	3167200040				330LA	3139800019
60EL	3167200060				350LA	3139800018
					370LA	3139800017
20JA/9020JA	3118400020				9160LA	3139800012
30JA/9030JA	3118400030				9198LA	3139800006
40JA/9040JA	3118400040				9200LA	3139800007
50JA/9050JA	3118400050				9210LA	3139800001
60JA/9060JA	3118400060					
70JA/9070JA	3118400070					
80JA	3118400080					
90JA	3118400090					
100JA	3118400100					



*Spring
Assembly*

Workstation Assemblies

Woodhead offers all the workstation assemblies and components you need. With Aero-Motive® workstation assemblies, you can optimize your use of space through bench, wall, or floor-mounted arms, as well as extended runways that increase horizontal space options. Pivoting fixture and trolley mounts provide quick access to tools and greater freedom of movement.

Layout Guidelines

- What kind of work flow occurs in the area in question? Is it a straight-line application? An X-Y axis? A radius application? In this catalog, we have indicated which workstations and components are suitable for each application.
- Consider the type of tool used and how much of the work area the tool must be able to reach.
- System total suspended weight should not exceed 50 pounds for 5400 products, 30 pounds for 5200. Total suspended weight includes tool balancer, suspended tool, balancer trolley and cable or hose.
- Maximum unsupported horizontal track length is 6 feet. When mounting horizontal lengths of track, it is essential that any one unsupported length of track not exceed this length.
- Maximum unsupported vertical track length is 6 feet. When using vertical lengths of track, it is essential that any one unsupported length of track not exceed this length. Unsupported vertical lengths of track that exceed 6 feet in height should be mounted to walls or work benches using a Model No. 5400-SC support clamp.

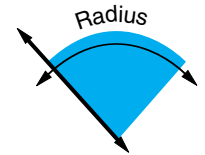
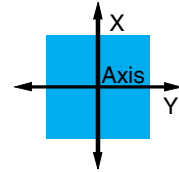

5200

WORKSTATION ASSEMBLIES

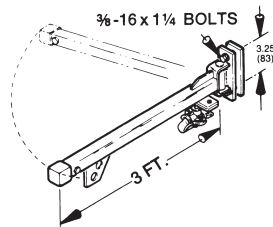

Wall-Mounted 180° Swinging Jib

Model No. 0525200034
 Max. Capacity 30 lbs. (13.6 Kg)
 Total Length 3 ft. (0.9 m)
 With Trolley and End Clamp
 .49" - 1.25" O.D.

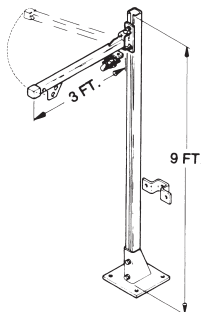
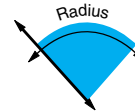

Floor/Bench-Mounted Swinging Jib

Model No. 0526200034
 Max. Capacity 30 lbs. (13.6 Kg)
 Total Length 3 ft. (0.9 m)
 With Trolley and End Clamp
 .49" - 1.25" O.D.
 (Must be used in conjunction with bench)

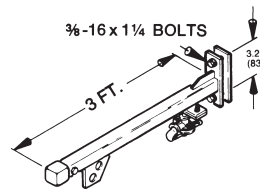
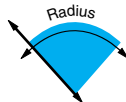

Wall-Mounted Fixed Jib

Model No. 0525100034
 Max. Capacity 30 lbs. (13.6 Kg)
 Total Length 3 ft. (0.9 m)
 With Trolley and End Clamp
 .49" - 1.25" O.D.



5400 WORKSTATION ASSEMBLIES

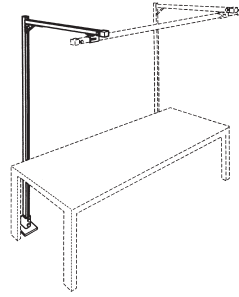

Floor-Mounted Runway Extension

Model No. 0544100069
Includes all necessary hardware — just add track to extend the system.

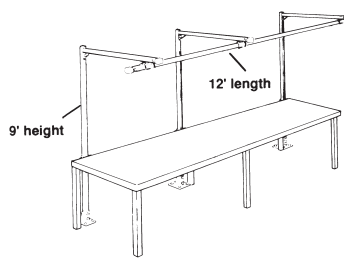
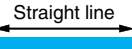

Triple Floor-Mounted Runway

Model No. 0544100012
Max. Capacity 50 lbs. (22.7 Kg)
Total Length 12 ft. (3.7m)
Bench and Cars not included

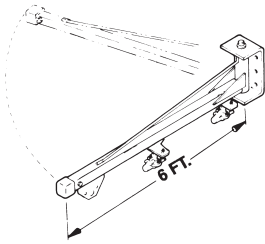

Wall-Mounted 180° Swinging Jib

Model No. 0545200064
Max. Capacity 50 lbs. (22.7 Kg)
Total Length 6 ft. (1.8m)

With Trolley, Intermediate Car and End Clamp
.49" - 1.25" O.D.

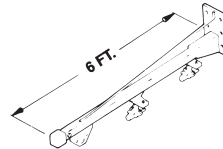
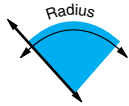

Wall-Mounted Fixed Jib

Model No. 0545100064
Max. Capacity 50 lbs. (22.7 Kg)
Total Length 6 ft. (1.8m)

With Trolley, Intermediate Car and End Clamp
.49" - 1.25" O.D.

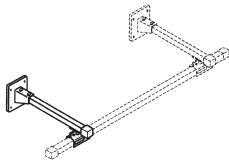

Wall-Mounted Runway Extension

Model No. 0544300069
Includes all necessary hardware; just add track to extend the system.

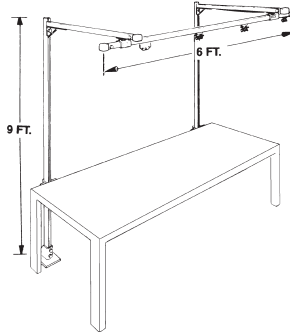

Double Floor-Mounted Runway

Model No. 0544100064
Max. Capacity 50 lbs. (22.7 Kg)
Total Length 6 ft. (1.8m)

With Trolley, Intermediate Cars and End Clamp
.49" - 1.25" O.D.

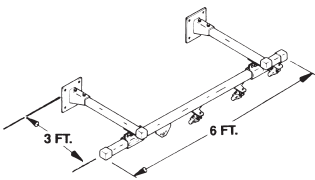

Double Wall-Mounted Runway

Model No. 0544300064
Max. Capacity 50 lbs. (22.7 Kg)
Total Length 6 ft. (1.8m)

With Trolley, Intermediate Car and End Clamp
.49" - 1.25" O.D.

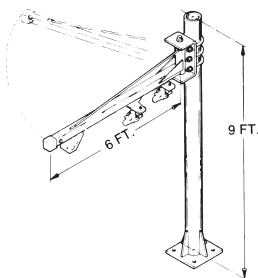

Floor-Mounted Swinging Jib

Model No. 0546200064
Max. Capacity = 50 lbs. (22.7 Kg)
Total Length = 6 ft. (1.8m)

With Trolley, Intermediate Cars and End Clamp
.49" - 1.25" O.D.

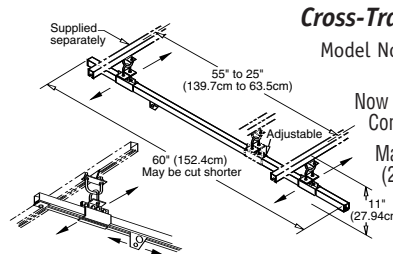
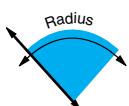

Cross-Tracker System

Model No. 54WB6
52WB6

Now available to cover X-Y axis. Consult factory.

Max. Capacity 50 lbs. (22.7 Kg) at 6 ft. span

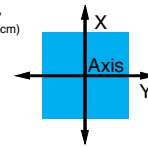

5200 & 5400 WORKSTATION COMPONENTS

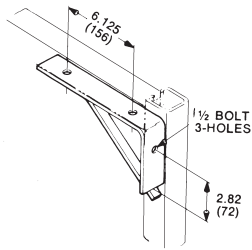

Angle Bracket
Model No. 5400AB

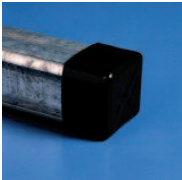

End Cap
Model No. 5400EC
5200EC

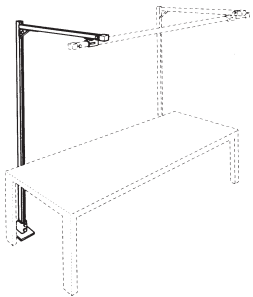

Floor-Mounted Runway Extension
Model No. 0544100069
Includes all necessary hardware; just add track to extend the system.

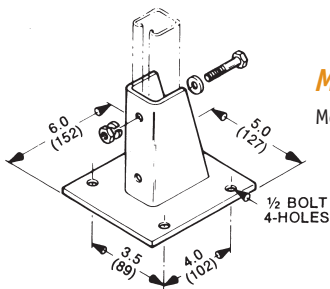

Mounting Plate
Model No. 5400MP
(For wall or floor mounting)

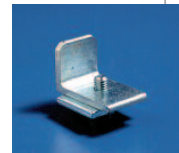

End Stop
Model No. 5400ES
5200ES

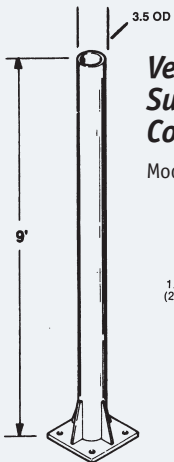

Vertical Support Column
Model No. 0545400009

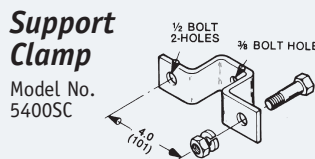
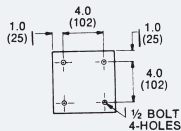

U-Bolt Assembly
Model No. 5400UB

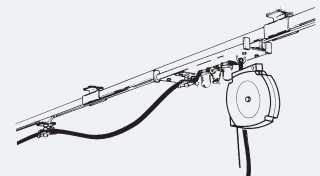

Ceiling-Mounted Runway
With FRL Trolley and BF Balancer



Track Nut
Model No. 5400TN

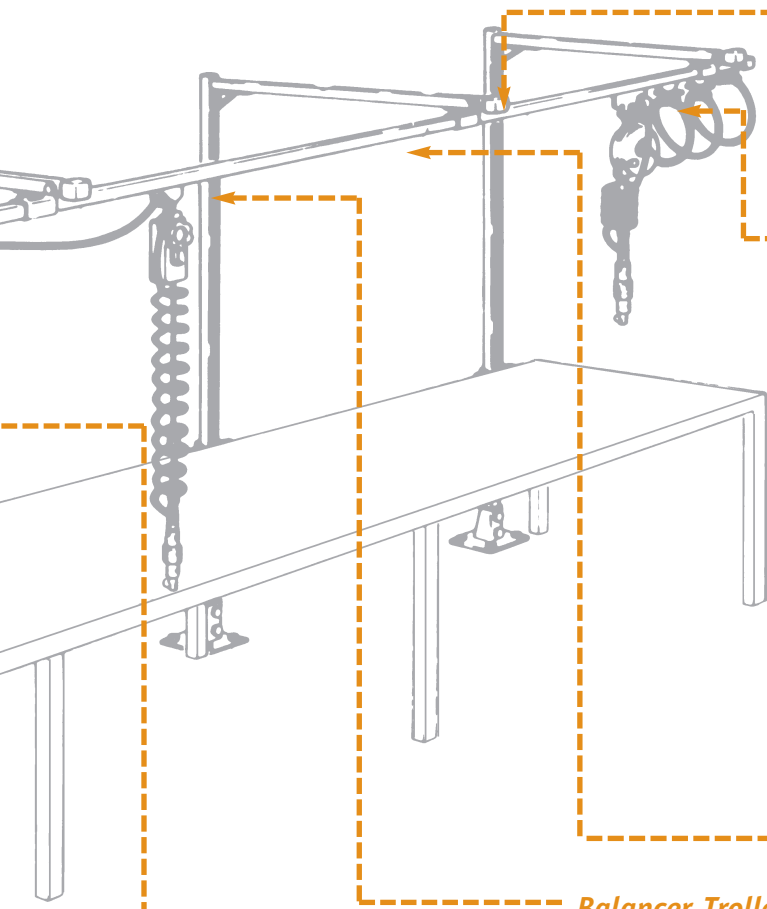

Joint Hanger Bracket

Model No. 5400JH
5200JH
To hang from Aero-Motive® track, add two 5400-TN (Track Nuts)

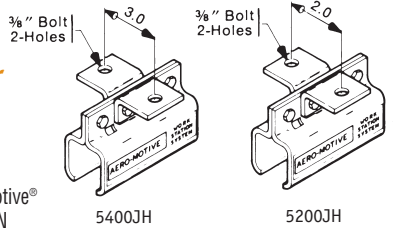

Intermediate Car

Model No. 0542100012 (0.49" - 0.90" O.D.)
Model No. 0543100012 (0.91" - 1.25" O.D.)
Model No. 5221-1 (0.49" - 0.91" O.D.)
Model No. 5231-1 (0.91" - 1.25" O.D.)

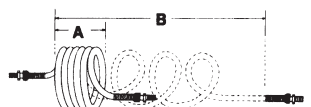

RECOIL HOSE			
Model	Size	A	B
0548200008	1/4"	6"	8'
0548200012	1/4"	8"	12'
0548300008	3/8"	6"	8'
0548300012	3/8"	8"	12'

Male swivel pipe fittings, both ends

Track

Model No. 54006: 6 ft. (1.5m)
52006: 6 ft. (1.5m)
Model No. 540012: 12 ft. (3.7m)
520012: 12 ft. (3.7m)



Horizontal Support Track

Model No. 0545300003: 3 ft. (.9m)

Vertical Support Track

Model No. 0545300009: 9 ft. (2.7m)

5200 - max. 30lb capacity
5400 - max. 50lb capacity

Balancer Trolley

Model No. 0541100012
0521100012



0541100012

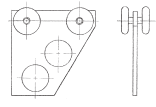

0521100012

End Clamp

Model No. 54212, 52212 (0.49" - 0.90" O.D.)
Model No. 54312, 52312 (0.91" - 1.25" O.D.)

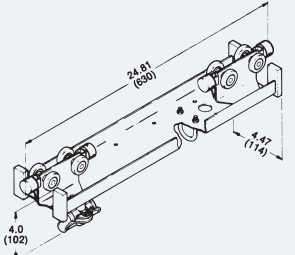

Filter Regulator Lubricator (FRL) Balancer Trolley

With provisions for FRL mounting
Model No. 5521FR (0.49" - 0.90" O.D.)
Model No. 5531FR (0.91" - 1.25" O.D.)

Balancer Trolley Hose Connector

Model No. 0547100001
May also be used with 5200 Balancer Trolley.

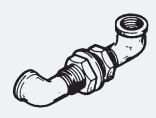

Hose Support

Model No. 6102000000 (0.49" - 0.90" O.D.)
Model No. 6102100000 (0.91" - 1.25" O.D.)
Hose/cable clamping capacity

Reducer Bushing

Model No. 00669P0041 (3/8" to 1/4")

Hose Connector shown with Model No. 0541100012

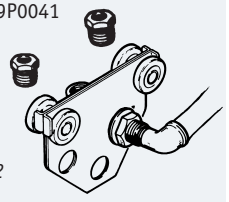



GM Positioner
(page 4)

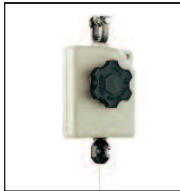
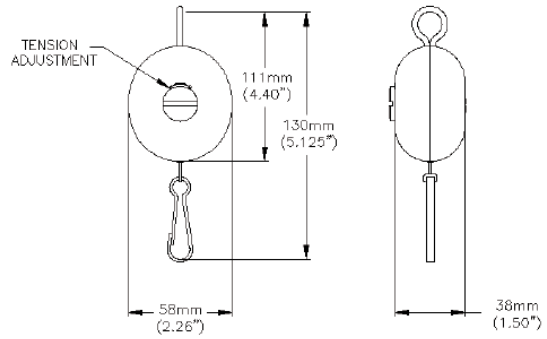

RB Retractor
(page 5)

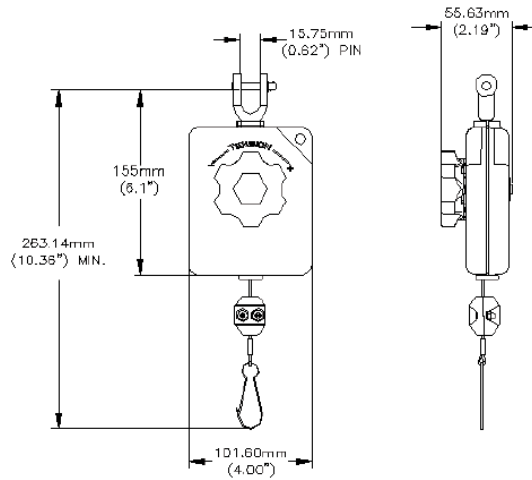

RF Retractor
(page 5)

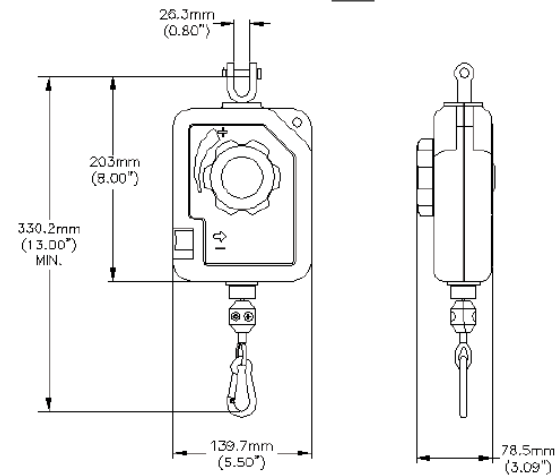

5F Retractors
(page 6)

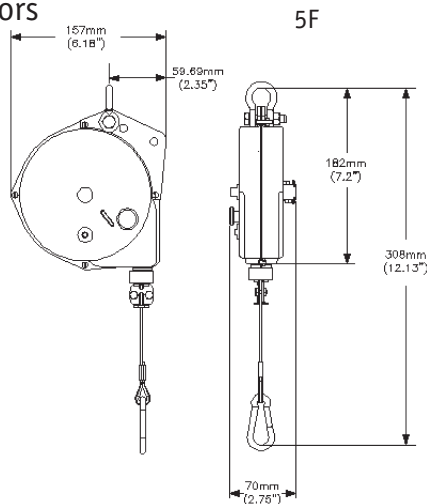

10F - 22F Retractors
(page 6)

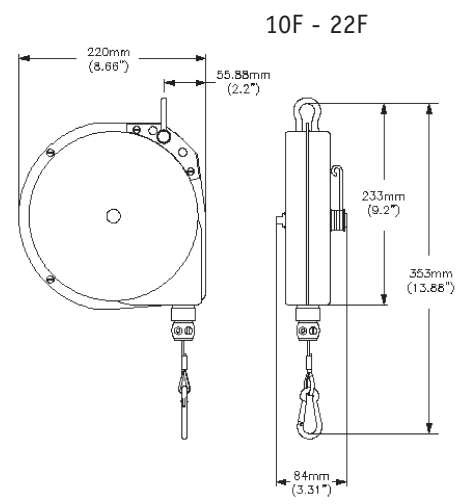



FLRC Retractors
(page 6)

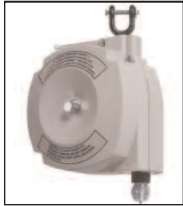
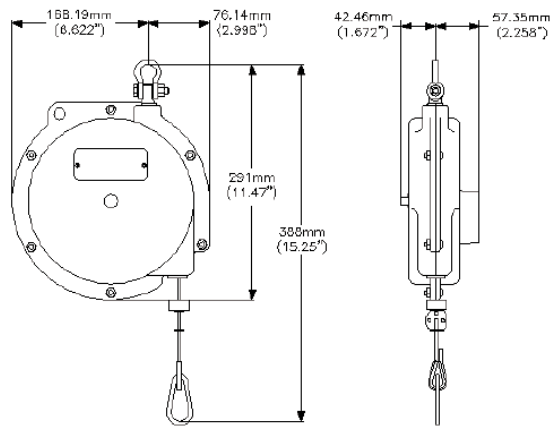

BF Balancer
(page 8)

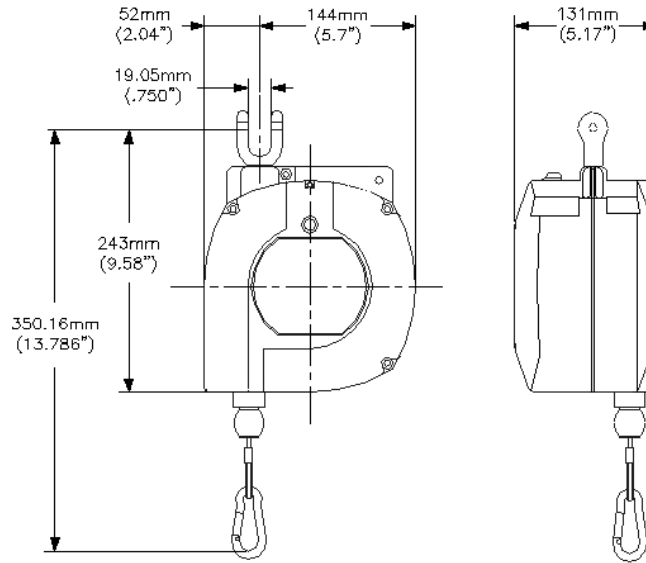

EB Balancer
(page 9)

