



Chipsmall Limited consists of a professional team with an average of over 10 year of expertise in the distribution of electronic components. Based in Hongkong, we have already established firm and mutual-benefit business relationships with customers from,Europe,America and south Asia,supplying obsolete and hard-to-find components to meet their specific needs.

With the principle of “Quality Parts,Customers Priority,Honest Operation,and Considerate Service”,our business mainly focus on the distribution of electronic components. Line cards we deal with include Microchip,ALPS,ROHM,Xilinx,Pulse,ON,Everlight and Freescale. Main products comprise IC,Modules,Potentiometer,IC Socket,Relay,Connector.Our parts cover such applications as commercial,industrial, and automotives areas.

We are looking forward to setting up business relationship with you and hope to provide you with the best service and solution. Let us make a better world for our industry!



## Contact us

Tel: +86-755-8981 8866 Fax: +86-755-8427 6832

Email & Skype: info@chipsmall.com Web: www.chipsmall.com

Address: A1208, Overseas Decoration Building, #122 Zhenhua RD., Futian, Shenzhen, China



REV.	DATE	DESCRIPTION
NC	01/16/03	INITIAL RELEASE
A	06/11/03	ADD MOUNTING HOLE DIMS.

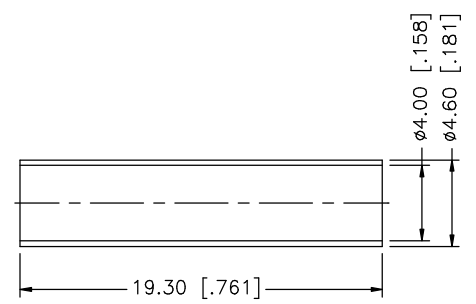
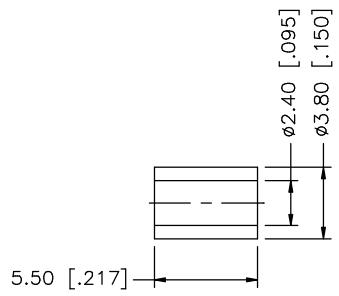
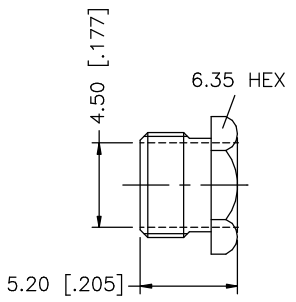
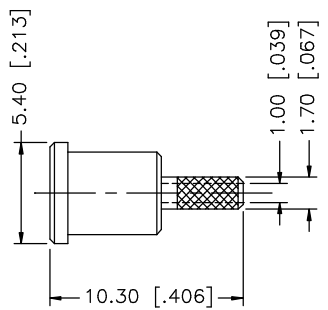
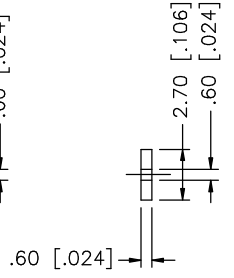
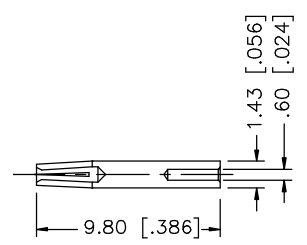
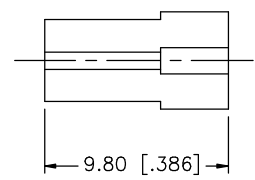
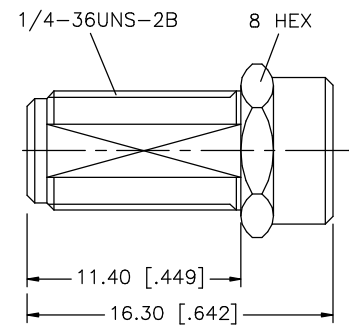
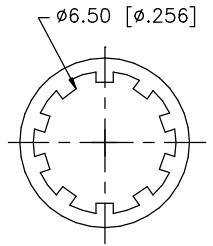
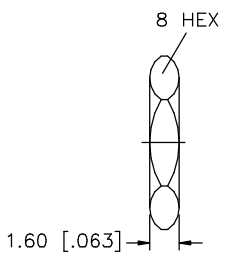
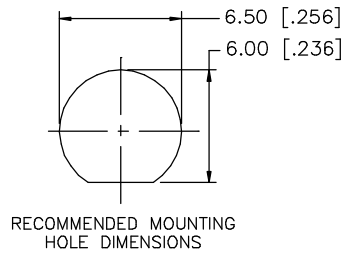
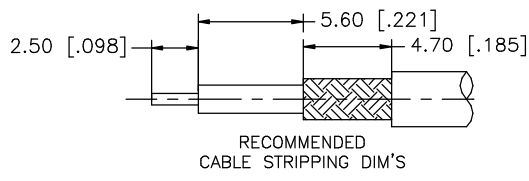

DESCRIPTION	MATERIAL	FINISH	QTY
8			
7	HEAT SHRINK		
6	FERRULE	COPPER	GOLD 1
5	HEX NUT	BRASS	GOLD 1
4	BARREL	BRASS	GOLD 1
3	CONTACT PIN	BRASS	GOLD 1
2	INSULATOR	TEFLON	NATURAL 1
1	HOUSING/BODY	BRASS	GOLD 1

UNLESS OTHERWISE SPECIFIED DIMENSIONS ARE IN MILLIMETERS. DIMENSIONS IN [ ] ARE IN INCHES AND FOR CUSTOMER REFERENCE ONLY.

UNLESS OTHERWISE SPECIFIED TOLERANCES FOR MILLIMETERS ARE:  
0.5 - 8mm ± 0.20mm  
8 - 30mm ± 0.40mm  
30 - 120mm ± 0.50mm

UNLESS OTHERWISE SPECIFIED TOLERANCES FOR INCHES ARE:  
.020 - .315 = ± 0.007"  
.315 - 1.180 = ± 0.015"  
1.180 - 4.724 = ± 0.020"

DO NOT SCALE DRAWING

APPROVALS	DATE
DRAWN G.R.S.	06/11/03
CHECKED	
ISSUED	
SHEET 1 OF 1	
CAD FILE C:/132/132220.DWG	

**Amphenol Connex**

PART DESCRIPTION  
**SMA BULKHEAD CRIMP JACK  
(FOR RG-178B/U, 196/U CABLE)**

PART NO. **132220**

DWG. NO. 132220.DWG	REV. A	SIZE A	SCALE NA
---------------------	--------	--------	----------