



Chipsmall Limited consists of a professional team with an average of over 10 year of expertise in the distribution of electronic components. Based in Hongkong, we have already established firm and mutual-benefit business relationships with customers from,Europe,America and south Asia,supplying obsolete and hard-to-find components to meet their specific needs.

With the principle of “Quality Parts,Customers Priority,Honest Operation,and Considerate Service”,our business mainly focus on the distribution of electronic components. Line cards we deal with include Microchip,ALPS,ROHM,Xilinx,Pulse,ON,Everlight and Freescale. Main products comprise IC,Modules,Potentiometer,IC Socket,Relay,Connector.Our parts cover such applications as commercial,industrial, and automotives areas.

We are looking forward to setting up business relationship with you and hope to provide you with the best service and solution. Let us make a better world for our industry!



Contact us

Tel: +86-755-8981 8866 Fax: +86-755-8427 6832

Email & Skype: info@chipsmall.com Web: www.chipsmall.com

Address: A1208, Overseas Decoration Building, #122 Zhenhua RD., Futian, Shenzhen, China



Sensor/Actuator cable - SAC-5P-M12MS/0,6-600/M12FS HD - 1404064

Please be informed that the data shown in this PDF Document is generated from our Online Catalog. Please find the complete data in the user's documentation. Our General Terms of Use for Downloads are valid (<http://download.phoenixcontact.com>)



Sensor/Actuator cable, 5-position, PP-EPDM halogen-free, Gray RAL 7035, Plug straight M12, A-coded, on Socket straight M12, A-coded, Cable length: 0.6 m, Hygienic design, With high-grade steel knurl



Key commercial data

Packing unit	0
Minimum order quantity	1
GTIN	 4 046356 678018
Custom tariff number	85444290
Country of origin	POLAND

Technical data

General data

Rated current at 40°C	4 A
Rated voltage	60 V
Number of positions	5
Volume resistance	≤ 5 mΩ
Insulation resistance	≥ 100 MΩ
Length of cable	0.6 m
Ambient temperature (operation)	-40 °C ... 105 °C (Male connector / female connector)

General characteristics

Standards/regulations	M12 plug-in connector IEC 61076-2-101
Coding	A - standard
Surge voltage category	II
Pollution degree	3
Degree of protection	IP65/IP68/IP69K
Insertion/withdrawal cycles	≥ 100
Torque	0.4 Nm (M12 plug-in connector)
Contact material	CuSn

Sensor/Actuator cable - SAC-5P-M12MS/0,6-600/M12FS HD - 1404064

Technical data

General characteristics

Contact surface material	Ni/Au
Contact carrier material	PP
Material of grip body	PP
Material, knurls	High-grade steel
Sealing material	FKM
Status display	No

Conductor data

Cable type	Halogen-free PP gray
Cable type (abbreviation)	600
Cable abbreviation	Li9Y9Y
Conductor cross section	5x 0.34 mm ² (signal line)
AWG signal line	22
Conductor structure signal line	42x 0.10 mm
Core diameter including insulation	1.27 mm ±0.02 mm (signal line)
Thickness, insulation	≥ 0.21 mm (Core insulation)
Wire colors	Brown, white, blue, black, gray
Overall twist	5 cores, twisted
Length of twist, overall twist	55 mm
External sheath, color	Gray RAL 7035
Outer sheath thickness	Approx. 0.7 mm
External cable diameter D	5 mm ±0.15 mm
Minimum bending radius, fixed installation	5 x D
Minimum bending radius, flexible installation	10 x D
Cable weight	34 kg/km
Outer sheath, material	PP-EPDM
Material conductor insulation	PP
Conductor material	Bare Cu litz wires
Conductor resistance	58 Ω/km (At an ambient temperature of 20°C)
Nominal voltage, conductor	≤ 300 V AC
Test voltage, conductor	≥ 3000 V AC
Special properties	FDA compliant
Halogen-free	in accordance with DIN VDE 0472 part 815
Ambient temperature (operation)	-40 °C ... 105 °C (cable, fixed installation)

Classifications

ETIM

ETIM 3.0	EC001855
ETIM 4.0	EC001855
ETIM 5.0	EC001855

Sensor/Actuator cable - SAC-5P-M12MS/0,6-600/M12FS HD - 1404064

Classifications

UNSPSC

UNSPSC 11	31251501
UNSPSC 12.01	31251501
UNSPSC 13.2	31251501
UNSPSC 6.01	31251501
UNSPSC 7.0901	31251501

eCl@ss

eCl@ss 4.0	27060306
eCl@ss 4.1	27060306
eCl@ss 5.0	27061801
eCl@ss 5.1	27061801
eCl@ss 6.0	27061801
eCl@ss 7.0	27061801

Accessories

Accessories

Tools

Torque screwdriver - TSD 04 SAC - 1208429



Torque screwdriver, with preset torque of 0.4 Nm and 4 mm hexagonal drive for M12 connectors

Torque screwdriver - TSD-M 1,2NM - 1212224



Torque screw driver, accuracy as per EN ISO 6789 standard, adjustable from 0.3 - 1.2 Nm

Adapter insert - TSD-M SAC-BIT ADAPTER - 1212600



Adapter bit for TSD-M...torque tools, E6.3-1/4" drive with 4 mm hexagon to accommodate SAC bits

Sensor/Actuator cable - SAC-5P-M12MS/0,6-600/M12FS HD - 1404064

Accessories

Adapter - SAC BIT M12-W14 - 1212513



SAC nut, for assembling M12 connectors with hexagonal high-grade steel knurl, with 4 mm hexagonal drive

Drawings

Schematic diagram

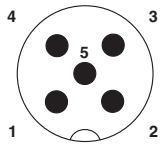

Pin assignment M12 male connector, 5-pos., A-coded, male side

Schematic diagram

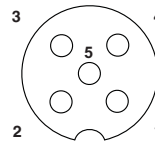

Pin assignment M12 socket, 5-pos., A-coded, socket side view

Cable cross section

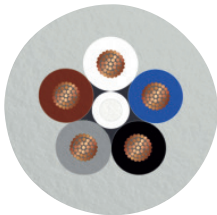

Halogen-free PP gray [600]

Circuit diagram



Contact assignment of the M12 connector and the M12 socket

Sensor/Actuator cable - SAC-5P-M12MS/0,6-600/M12FS HD - 1404064

Dimensioned drawing

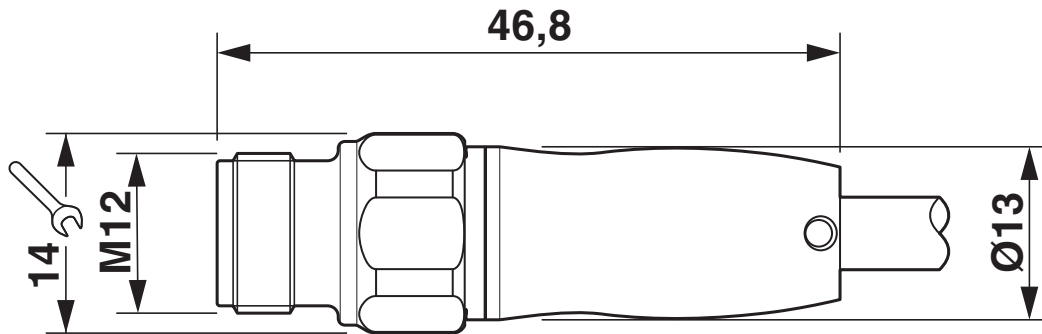

Sensor/Actuator cable - SAC-5P-M12MS/0,6-600/M12FS HD - 1404064

Dimensioned drawing

