



Chipsmall Limited consists of a professional team with an average of over 10 year of expertise in the distribution of electronic components. Based in Hongkong, we have already established firm and mutual-benefit business relationships with customers from,Europe,America and south Asia,supplying obsolete and hard-to-find components to meet their specific needs.

With the principle of “Quality Parts,Customers Priority,Honest Operation,and Considerate Service”,our business mainly focus on the distribution of electronic components. Line cards we deal with include Microchip,ALPS,ROHM,Xilinx,Pulse,ON,Everlight and Freescale. Main products comprise IC,Modules,Potentiometer,IC Socket,Relay,Connector.Our parts cover such applications as commercial,industrial, and automotives areas.

We are looking forward to setting up business relationship with you and hope to provide you with the best service and solution. Let us make a better world for our industry!



Contact us

Tel: +86-755-8981 8866 Fax: +86-755-8427 6832

Email & Skype: info@chipsmall.com Web: www.chipsmall.com

Address: A1208, Overseas Decoration Building, #122 Zhenhua RD., Futian, Shenzhen, China



Distributor - SAC-ASI-J-Y-N-PUR-1,0-FS SCO - 1407573

Please be informed that the data shown in this PDF Document is generated from our Online Catalog. Please find the complete data in the user's documentation. Our General Terms of Use for Downloads are valid (<http://phoenixcontact.com/download>)



AS-Interface distributor with a high degree of protection, for a branch from one flat-ribbon conductor to a 1.0 m PUR round cable with straight M12-SPEEDCON socket



Key Commercial Data

Packing unit	1 STK
GTIN	 4 046356 779937
GTIN	4046356779937

Technical data

Mechanical characteristics

Number of positions	2
Shielded	No
Insertion/withdrawal cycles	≥ 100 (M12 connector)
Connection method	AS-i penetration technique
Cable diameter	4.30 mm
Length of cable	1 m
Color	black
Tightening torque, min.	1.65 Nm
Degree of protection	IP65/IP67

Ambient conditions

Ambient temperature (operation)	-25 °C ... 75 °C (Plug / socket)
	-25 °C ... 80 °C (cable, flexible installation)
	-40 °C ... 80 °C (cable, fixed installation)
Ambient temperature (storage/transport)	-25 °C ... 85 °C
Degree of protection	IP65
	IP67

Material data

Distributor - SAC-ASI-J-Y-N-PUR-1,0-FS SCO - 1407573

Technical data

Material data

Housing material	PBT
Contact material	CuSn
Contact surface material	Au
Material	CuSn (M12 contact)
	TPU GF (M12 contact carrier)
	Ni/Au (M12 contact surface)
	TPU (M12 handle)
Cable gland material	Zinc die-cast, nickel-plated
Outer sheath, material	PUR
External sheath, color	black RAL 9005

Electrical characteristics

Rated voltage (III/3)	≤ 32 V
Rated current	≤ 4 A

Pin assignment

Position = wire color (signal) = position (optional)	1 (M12 socket) BN AS-i+ 3.1 (AS-i distributors)
	2 (M12 socket) N.C.
	3 (M12 socket) BU AS-i- 3.2 (AS-i distributors)
	4 (M12 socket) N.C.
	5 (M12 socket) N.C.

Line characteristics

Cable type	PUR halogen-free black
Cable abbreviation	LIF9Y11YFHF
UL AWM style	20549 / 10493
Conductor cross section	4x 0.34 mm ² (Signal line)
AWG signal line	22
Conductor structure signal line	42x 0.10 mm
Core diameter including insulation	1.25 mm ±0.05 mm
External cable diameter	4.3 mm ±0.2 mm
Wire colors	brown, white, blue, black
External sheath, color	black
Transmission medium	Copper
Overall twist	4 wires, twisted
Outer sheath, material	PUR
Material conductor insulation	PP
Conductor material	Bare Cu litz wires
Ambient temperature (operation)	-40 °C ... 80 °C (fixed routing)
	-25 °C ... 80 °C (Flexibly installed)

Drawings

Distributor - SAC-ASI-J-Y-N-PUR-1,0-FS SCO - 1407573

Schematic diagram

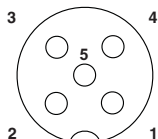

Pin assignment M12, PIN 1: AS-i +, PIN 3: AS-i -, PIN 2,4,5: Not used

Cable cross section

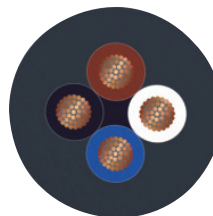

PUR halogen-free black [PUR]

Dimensional drawing

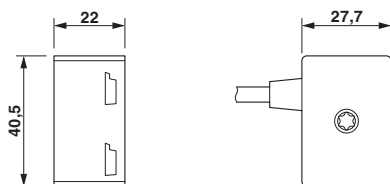

Distributor, AS-Interface

Dimensional drawing

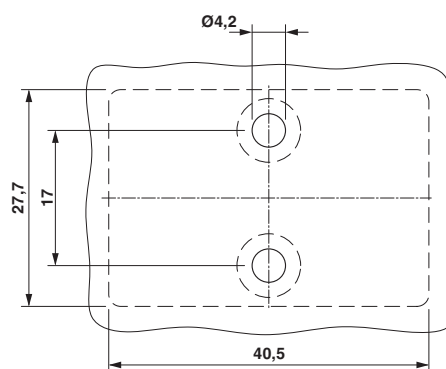

Distance and position of the mounting holes

Circuit diagram

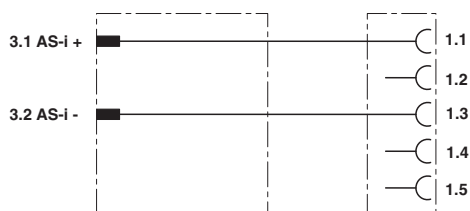

Contact assignment of the AS-Interface distributor

Dimensional drawing

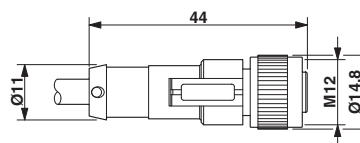

M12 x 1 socket, straight