



Chipsmall Limited consists of a professional team with an average of over 10 year of expertise in the distribution of electronic components. Based in Hongkong, we have already established firm and mutual-benefit business relationships with customers from,Europe,America and south Asia,supplying obsolete and hard-to-find components to meet their specific needs.

With the principle of “Quality Parts,Customers Priority,Honest Operation,and Considerate Service”,our business mainly focus on the distribution of electronic components. Line cards we deal with include Microchip,ALPS,ROHM,Xilinx,Pulse,ON,Everlight and Freescale. Main products comprise IC,Modules,Potentiometer,IC Socket,Relay,Connector.Our parts cover such applications as commercial,industrial, and automotives areas.

We are looking forward to setting up business relationship with you and hope to provide you with the best service and solution. Let us make a better world for our industry!



## Contact us

Tel: +86-755-8981 8866 Fax: +86-755-8427 6832

Email & Skype: info@chipsmall.com Web: www.chipsmall.com

Address: A1208, Overseas Decoration Building, #122 Zhenhua RD., Futian, Shenzhen, China



## Power cable - SAC-4P-M12MRT/ 1,0-PUR/M12FRT - 1415196

Please be informed that the data shown in this PDF Document is generated from our Online Catalog. Please find the complete data in the user's documentation. Our General Terms of Use for Downloads are valid (<http://phoenixcontact.com/download>)



Power cable, 4-position, PUR halogen-free, black-gray RAL 7021, Plug angled M12, T-coded, on Socket angled M12, T-coded, cable length: 1 m

### Why buy this product

- ✓ Easy and safe: 100% electrically tested plug-in components
- ✓ High-performance: DC connectors for up to 12 A and 63 V DC
- ✓ Protection against incorrect connection using special T-coding
- ✓ Our standard: robust halogen-free PUR cable

### Key Commercial Data

Packing unit	1 STK
GTIN	 4 055626 041216
GTIN	4055626041216

### Technical data

#### Dimensions

Length of cable	1 m
-----------------	-----

#### Ambient conditions

Ambient temperature (operation)	-25 °C ... 85 °C (Plug / socket)
Degree of protection	IP65
	IP67
	IP68

#### General

Rated current at 40°C	12 A
Rated voltage	63 V (DC)
	63 V DC
Number of positions	4

# Power cable - SAC-4P-M12MRT/ 1,0-PUR/M12FRT - 1415196

## Technical data

### General

Insulation resistance	≥ 100 MΩ
Coding	T power
Status display	No
Protective circuit/component	Unwired
Overvoltage category	III
Degree of pollution	3
Insertion/withdrawal cycles	> 100
Torque	0.4 Nm (M12 connector)

### Material

Flammability rating according to UL 94	V0
Contact material	CuSn
Contact surface material	Ni/Au
Contact carrier material	PA
Material of grip body	PA
Material, knurls	Zinc die-cast, nickel-plated

### Standards and Regulations

Flammability rating according to UL 94	V0
--	----

### Cable

Cable type	PUR halogen-free black
Cable type (abbreviation)	PUR
Cable abbreviation	Li9YV1-11Y
UL AWM style	20233 / 10493 (80°C/300 V)
Conductor cross section	4x 1.5 mm <sup>2</sup>
AWG power supply	16
Conductor structure, voltage supply	78x 0.15 mm
Core diameter including insulation	2.35 mm ±0.05 mm
Thickness, insulation	≥ 0.25 mm
Wire colors	brown, white, blue, black
Overall twist	4 wires, twisted
Length of twist, overall twist	90 mm
External sheath, color	black-gray RAL 7021
Outer sheath thickness	approx. 1.3 mm
External cable diameter D	8.4 mm ±0.25 mm
Minimum bending radius, fixed installation	5 x D
Minimum bending radius, flexible installation	10 x D
Number of bending cycles	4000000
Minimum bending radius, drag chain applications	10 x D
Traversing path	10 m
Traversing rate	3 m/s

# Power cable - SAC-4P-M12MRT/ 1,0-PUR/M12FRT - 1415196

## Technical data

### Cable

Acceleration	10 m/s <sup>2</sup>
Cable weight	109 kg/km
Outer sheath, material	PUR
Material conductor insulation	PP
Conductor material	Bare Cu litz wires
Insulation resistance	≥ 1 GΩ*km (at 20 °C)
Conductor resistance	≤ 13 Ω/km (at 20 °C)
Nominal voltage, cable	≤ 300 V AC
Test voltage, cable	≥ 3000 V AC (Spark test)
Flame resistance	According to UL 758/1581 (Cable Flame)
	according to UL 758/1581 FT1
	According to DIN EN 60332-1-2
Halogen-free	in accordance with DIN VDE 0472 part 815
	in accordance with DIN EN 50267-2-1
Resistance to oil	According to DIN EN 60811-2-1, 168 h at 100°C
	According to UL 758, 168 h at 60°C
Other resistance	Hydrolysis and microbe resistant as per VDE 0282 section 10
	Low adhesion
	abrasion-resistant
	Resistant to salt water
Ambient temperature (operation)	-50 °C ... 80 °C (cable, fixed installation)
	-30 °C ... 80 °C (cable, flexible installation)

### Environmental Product Compliance

REACH SVHC	Lead 7439-92-1
China RoHS	Environmentally Friendly Use Period = 50
	For details about hazardous substances go to tab "Downloads", Category "Manufacturer's declaration"

## Drawings

Schematic diagram

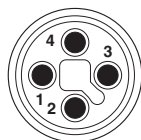

Pin assignment for M12 plug, 4-pos., T-coded, view of plug side

Schematic diagram

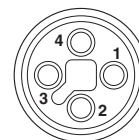

Pin assignment of M12 socket, 4-pos., T-coded, socket side view

# Power cable - SAC-4P-M12MRT/ 1,0-PUR/M12FRT - 1415196

Cable cross section

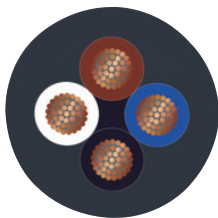

PUR halogen-free black [PUR]

Dimensional drawing

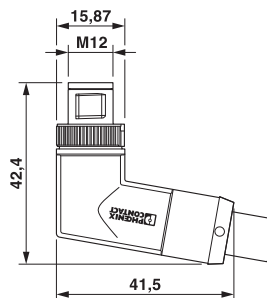

M12 x 1 male plug, angled

Dimensional drawing

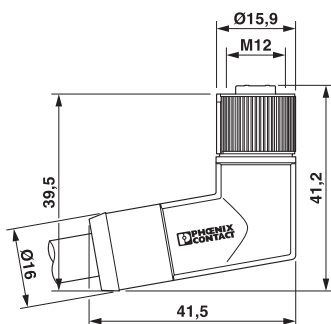

M12 x 1 socket, angled

Circuit diagram

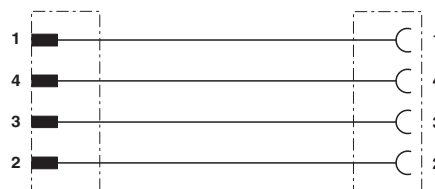

Contact assignment of M12 connector/socket

## Approvals

### Approvals

Approvals

UL Listed / cUL Listed / cULus Listed

Ex Approvals

### Approval details

UL Listed		<a href="http://database.ul.com/cgi-bin/XYV/template/LISEXT/1FRAME/index.htm">http://database.ul.com/cgi-bin/XYV/template/LISEXT/1FRAME/index.htm</a>	E468743
Nominal voltage UN	63 V		
Nominal current IN	12 A		
mm <sup>2</sup> /AWG/kcmil	16		

# Power cable - SAC-4P-M12MRT/ 1,0-PUR/M12FRT - 1415196

## Approvals

cUL Listed		<a href="http://database.ul.com/cgi-bin/XYV/template/LISEXT/1FRAME/index.htm">http://database.ul.com/cgi-bin/XYV/template/LISEXT/1FRAME/index.htm</a>	E468743
Nominal voltage UN		63 V	
Nominal current IN		12 A	
mm <sup>2</sup> /AWG/kcmil		16	

cULus Listed	
--------------	---

Phoenix Contact 2018 © - all rights reserved  
<http://www.phoenixcontact.com>

PHOENIX CONTACT GmbH & Co. KG  
Flachsmarktstr. 8  
32825 Blomberg  
Germany  
Tel. +49 5235 300  
Fax +49 5235 3 41200  
<http://www.phoenixcontact.com>