



Chipsmall Limited consists of a professional team with an average of over 10 year of expertise in the distribution of electronic components. Based in Hongkong, we have already established firm and mutual-benefit business relationships with customers from,Europe,America and south Asia,supplying obsolete and hard-to-find components to meet their specific needs.

With the principle of “Quality Parts,Customers Priority,Honest Operation,and Considerate Service”,our business mainly focus on the distribution of electronic components. Line cards we deal with include Microchip,ALPS,ROHM,Xilinx,Pulse,ON,Everlight and Freescale. Main products comprise IC,Modules,Potentiometer,IC Socket,Relay,Connector.Our parts cover such applications as commercial,industrial, and automotives areas.

We are looking forward to setting up business relationship with you and hope to provide you with the best service and solution. Let us make a better world for our industry!



Contact us

Tel: +86-755-8981 8866 Fax: +86-755-8427 6832

Email & Skype: info@chipsmall.com Web: www.chipsmall.com

Address: A1208, Overseas Decoration Building, #122 Zhenhua RD., Futian, Shenzhen, China



Flush-type connector - SACC-DSIV-MS-8CON-L90 SH SCO - 1437012

Please be informed that the data shown in this PDF Document is generated from our Online Catalog. Please find the complete data in the user's documentation. Our General Terms of Use for Downloads are valid (<http://phoenixcontact.com/download>)



Sensor/actuator flush-type connector, connector, 8-pos., M12 SPEEDCON, A-coded, shielded, rear/screw mounting with M12 thread, with polarity protection, with angled solder connection



Key Commercial Data

Packing unit	10 STK
GTIN	
GTIN	4046356438582

Technical data

Ambient conditions

Ambient temperature (operation)	-25 °C ... 85 °C (Plug / socket)
Degree of protection	IP67

General

Rated current at 40°C	2 A
Rated voltage	30 V
Number of positions	8
Insulation resistance	≥ 100 MΩ
Coding	A - standard
Status display	No
Overvoltage category	II
Degree of pollution	3
Connection method	Solder pins
Mounting type	Rear mounting M12 x 1

Material

Flammability rating according to UL 94	V0
Contact material	CuZn
Contact surface material	Au

Flush-type connector - SACC-DSIV-MS-8CON-L90 SH SCO - 1437012

Technical data

Material

Contact carrier material	PA 6.6
Material, knurls	Zinc die-cast, nickel-plated
Sealing material	NBR

Standards and Regulations

Flammability rating according to UL 94	V0
--	----

Environmental Product Compliance

REACH SVHC	Lead 7439-92-1
China RoHS	Environmentally Friendly Use Period = 50
	For details about hazardous substances go to tab "Downloads", Category "Manufacturer's declaration"

Drawings

Schematic diagram

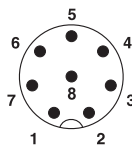

Pin assignment M12 plug, 8-pos., A-coded, view plug side

Drilling diagram

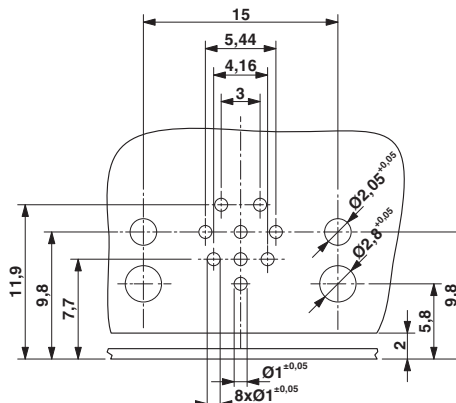

Drilling diagram

Dimensional drawing

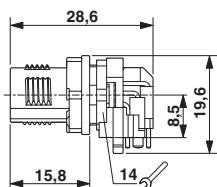

M12 flush-type connector, connector, side view

Dimensional drawing

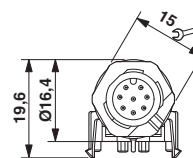

M12 flush-type connector, connector, front view

Flush-type connector - SACC-DSIV-MS-8CON-L90 SH SCO - 1437012

Dimensional drawing

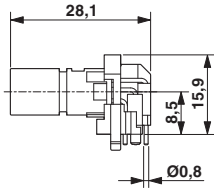

M12 flush-type connector, plug, contact carrier, side view

Dimensional drawing

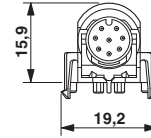

M12 flush-type connector, plug, contact carrier, front view

Dimensional drawing

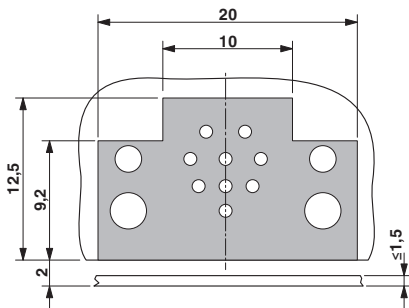

Locked area on the PCB

Dimensional drawing

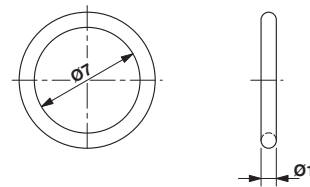

Optionally with O-ring (green) for tight seal when plugged in.
 - the axial mating force of 80 N per connector may not be exceeded when using with assembled O-ring!
 - Avoid radial forces!

Dimensional drawing

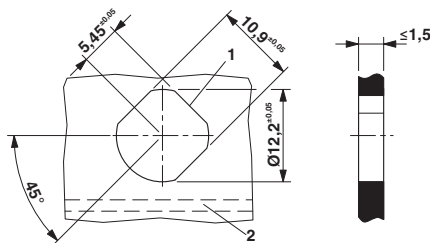

Panel cutout, view from front in case of horizontal PCB (2). The 3rd flat area is optional (1).

Approvals

Approvals

Approvals

UL Recognized / EAC

Ex Approvals

Flush-type connector - SACC-DSIV-MS-8CON-L90 SH SCO - 1437012

Approvals

Approval details

UL Recognized		http://database.ul.com/cgi-bin/XYV/template/LISEXT/1FRAME/index.htm	FILE E 118976
Nominal voltage UN		30 V	
Nominal current IN		2 A	
mm ² /AWG/kcmil		24	

EAC		B.01742
-----	---	---------

Phoenix Contact 2018 © - all rights reserved
<http://www.phoenixcontact.com>

PHOENIX CONTACT GmbH & Co. KG
Flachsmarktstr. 8
32825 Blomberg
Germany
Tel. +49 5235 300
Fax +49 5235 3 41200
<http://www.phoenixcontact.com>