



Chipsmall Limited consists of a professional team with an average of over 10 year of expertise in the distribution of electronic components. Based in Hongkong, we have already established firm and mutual-benefit business relationships with customers from,Europe,America and south Asia,supplying obsolete and hard-to-find components to meet their specific needs.

With the principle of “Quality Parts,Customers Priority,Honest Operation,and Considerate Service”,our business mainly focus on the distribution of electronic components. Line cards we deal with include Microchip,ALPS,ROHM,Xilinx,Pulse,ON,Everlight and Freescale. Main products comprise IC,Modules,Potentiometer,IC Socket,Relay,Connector.Our parts cover such applications as commercial,industrial, and automotives areas.

We are looking forward to setting up business relationship with you and hope to provide you with the best service and solution. Let us make a better world for our industry!



Contact us

Tel: +86-755-8981 8866 Fax: +86-755-8427 6832

Email & Skype: info@chipsmall.com Web: www.chipsmall.com

Address: A1208, Overseas Decoration Building, #122 Zhenhua RD., Futian, Shenzhen, China



LOC	DIST	REVISIONS					
		P	LTR	DESCRIPTION	DATE	DWN	APVD
-	-	-	-	SEE SHEET 1	-	-	-

- △1 CIRCUITS LOADED: 1, 2, 3, 8, 10, 12, 17, 18, 19.
- △2 PRELIMINARY PART NUMBER.
- △3 CIRCUITS LOADED: 1, 2, 3, 4, 7, 8, 12, 13, 16, 17, 18, 19.
- △4 CIRCUITS LOADED: 1, 2, 3, 4, 7, 8, 10, 12, 13, 16, 17, 18, 19.
- △5 CIRCUITS LOADED: ALL
- △6 CIRCUITS LOADED: 1, 2, 3, 4, 5, 6, 7, 8, 9, 11, 12, 13, 14, 15, 16, 17, 18, 19.
- △7 CIRCUITS LOADED: 1, 2, 3, 4, 5, 6, 7, 8, 10, 12, 13, 14, 15, 16, 17, 18, 19.
- △8 CIRCUITS LOADED: 1, 2, 3, 4, 5, 6, 7, 8, 12, 13, 14, 15, 16, 17, 18, 19.
- △9 CIRCUITS LOADED: 1, 2, 3, 4, 7, 8, 9, 10, 11, 12, 13, 16, 17, 18, 19.
- △10 CIRCUITS LOADED: 1, 2, 3, 4, 7, 8, 9, 11, 12, 13, 16, 17, 18, 19.

BLACK	△1	9	POSITIVE	0°	△2 1-1445777-7
WHITE	△3	12	BREAKAWAY	30°	△2 1-1445777-6
BLACK	△3	12	POSITIVE	0°	△2 1-1445777-5
WHITE	△4	13	BREAKAWAY	30°	△2 1-1445777-4
BLACK	△4	13	POSITIVE	0°	△2 1-1445777-3
WHITE	△10	14	BREAKAWAY	30°	△2 1-1445777-2
BLACK	△10	14	POSITIVE	0°	△2 1-1445777-1
WHITE	△9	15	BREAKAWAY	30°	△2 1-1445777-0
BLACK	△9	15	POSITIVE	0°	△2 1445777-09
WHITE	△8	16	BREAKAWAY	30°	△2 1445777-08
BLACK	△8	16	POSITIVE	0°	△2 1445777-07
WHITE	△7	17	BREAKAWAY	30°	△2 1445777-06
BLACK	△7	17	POSITIVE	0°	△2 1445777-05
WHITE	△6	18	BREAKAWAY	30°	△2 1445777-04
BLACK	△6	18	POSITIVE	0°	△2 1445777-03
WHITE	△5	19	BREAKAWAY	30°	△2 1445777-02
BLACK	△5	19	POSITIVE	0°	1445777-01
HOUSING COLOR	CIRCUITS LOADED	CONTACT QTY	LATCH	A REF	PART NUMBER

<small>THIS DRAWING IS A CONTROLLED DOCUMENT FOR TYCO ELECTRONICS CORPORATION IT IS SUBJECT TO CHANGE AND SHOULD BE USED ONLY FOR THE INTENDED ORGANIZATION SHOULD BE CONTACTED FOR THE LATEST REVISION.</small>		DWN 04SEP2001 SHANE WILES CWR 04SEP2001 G DOUITY APVD -	Tyco Electronics Harrisburg, PA 17105-3608
DIMENSIONS: mm 	TOLERANCES UNLESS OTHERWISE SPECIFIED: 0 PLC ±: 1 PLC ±: 2 PLC ±0.13 3 PLC ±: 4 PLC ±: ANGLES ±:	NAME ASSEMBLY, PLUG, SOLDER CUP, 19 POSITION, MICRO CPC PRODUCT SPEC APPLICATION SPEC WEIGHT FINISH CUSTOMER DRAWING	SIZE A2 CAGE CODE 00779 DRAWING NO. C=1445777 RESTRICTED TO SCALE 4:1 SHEET 2 OF 2 REV 10

LOC	DIST	REVISIONS					
		P	LTR	DESCRIPTION	DATE	DWN	APVD
-	-	8		REVISED	14MAY03	BH	KD
		9		ADDED 'B'. A REF. 30° WAS 10°	5-28-03	GD	KD
		10		ADDED P/NS, NOTES, HOUSING COLOR, SHEET 2.	4-08-04		

LATCH IDENTIFIER
 B-BREAKAWAY LATCH
 BREAKAWAY VERSION ONLY,
 MAY BE ORIENTED
 IN ANY DIRECTION

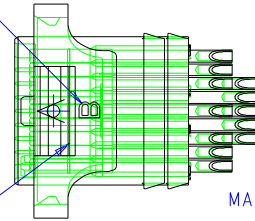

HOUSING, QTY-1
 MATERIAL: THERMOPLASTIC, COLOR-SEE TABLE

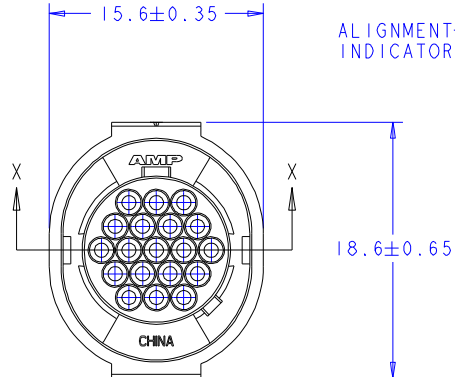

ALIGNMENT
 INDICATOR

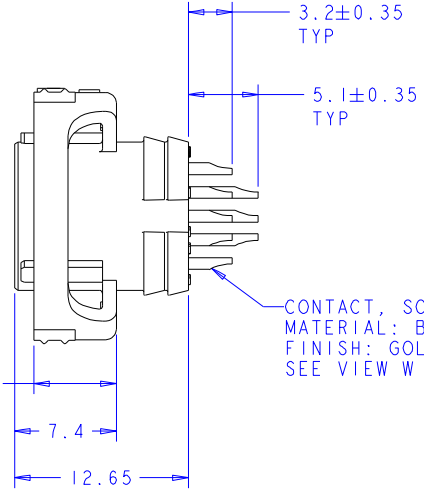

CONTACT, SOLDER CUP, QTY-19
 MATERIAL: BRASS
 FINISH: GOLD OVER NICKEL
 SEE VIEW W FOR CONTACT ORIENTATION

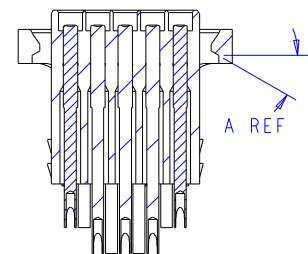
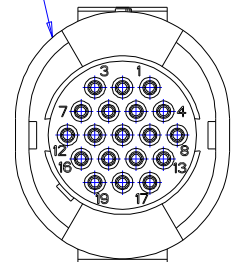

SECTION X-X

A REF

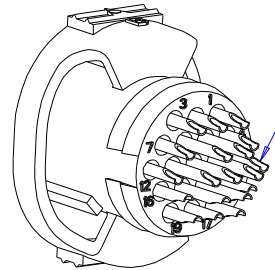

SOLDER TERMINATION
 AREA OF ALL
 CONTACTS IN CIRCUITS
 #8 THRU #12
 MAY BE ORIENTED
 UP OR DOWN

VIEW W

THIS PRODUCT HAS NOT COMPLETED
 VALIDATION TESTING

<small>THIS DRAWING IS A CONTROLLED DOCUMENT FOR TYCO ELECTRONICS CORPORATION IT IS SUBJECT TO CHANGE AND YOU CONTROL THE INFORMATION DISSEMINATION POLICY OF CONTACTS FOR THE LATEST REVISION.</small>		DWN: 04SEP2001 SHANE WILES CWR: 04SEP2001 G. DOUITY	Tyco Electronics Harrisburg, PA 17105-3608
DIMENSIONS: mm	TOLERANCES UNLESS OTHERWISE SPECIFIED: 0 PLC ±. 1 PLC ±. 2 PLC ±0.13 3 PLC ±. 4 PLC ±. ANGLES ±. FINISH	NAME: ASSEMBLY, PLUG, SOLDER CUP, 19 POSITION, MICRO CPC	SIZE: A2 CAGE CODE: 00779 DRAWING NO: C-1445777
MATERIAL: SEE CALLOUT	FINISH: SEE CALLOUT	WEIGHT: - CUSTOMER DRAWING	RESTRICTED TO: - SCALE: 4:1 SHEET: 1 OF 2 REV: 10