



Chipsmall Limited consists of a professional team with an average of over 10 year of expertise in the distribution of electronic components. Based in Hongkong, we have already established firm and mutual-benefit business relationships with customers from,Europe,America and south Asia,supplying obsolete and hard-to-find components to meet their specific needs.

With the principle of “Quality Parts,Customers Priority,Honest Operation,and Considerate Service”,our business mainly focus on the distribution of electronic components. Line cards we deal with include Microchip,ALPS,ROHM,Xilinx,Pulse,ON,Everlight and Freescale. Main products comprise IC,Modules,Potentiometer,IC Socket,Relay,Connector.Our parts cover such applications as commercial,industrial, and automotives areas.

We are looking forward to setting up business relationship with you and hope to provide you with the best service and solution. Let us make a better world for our industry!



Contact us

Tel: +86-755-8981 8866 Fax: +86-755-8427 6832

Email & Skype: info@chipsmall.com Web: www.chipsmall.com

Address: A1208, Overseas Decoration Building, #122 Zhenhua RD., Futian, Shenzhen, China



THIS DRAWING IS UNPUBLISHED. RELEASED FOR PUBLICATION
 © COPYRIGHT - By - ALL RIGHTS RESERVED.

LOC	DIST	REVISIONS					
		P	LTR	DESCRIPTION	DATE	DWN	APVD
J	-		P1	RELEASED(ECR-16-003113)	01MAR2016	J.J	W.H

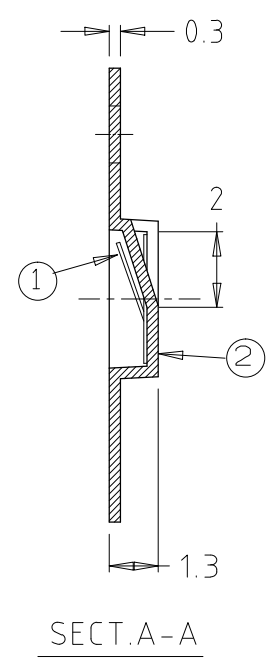
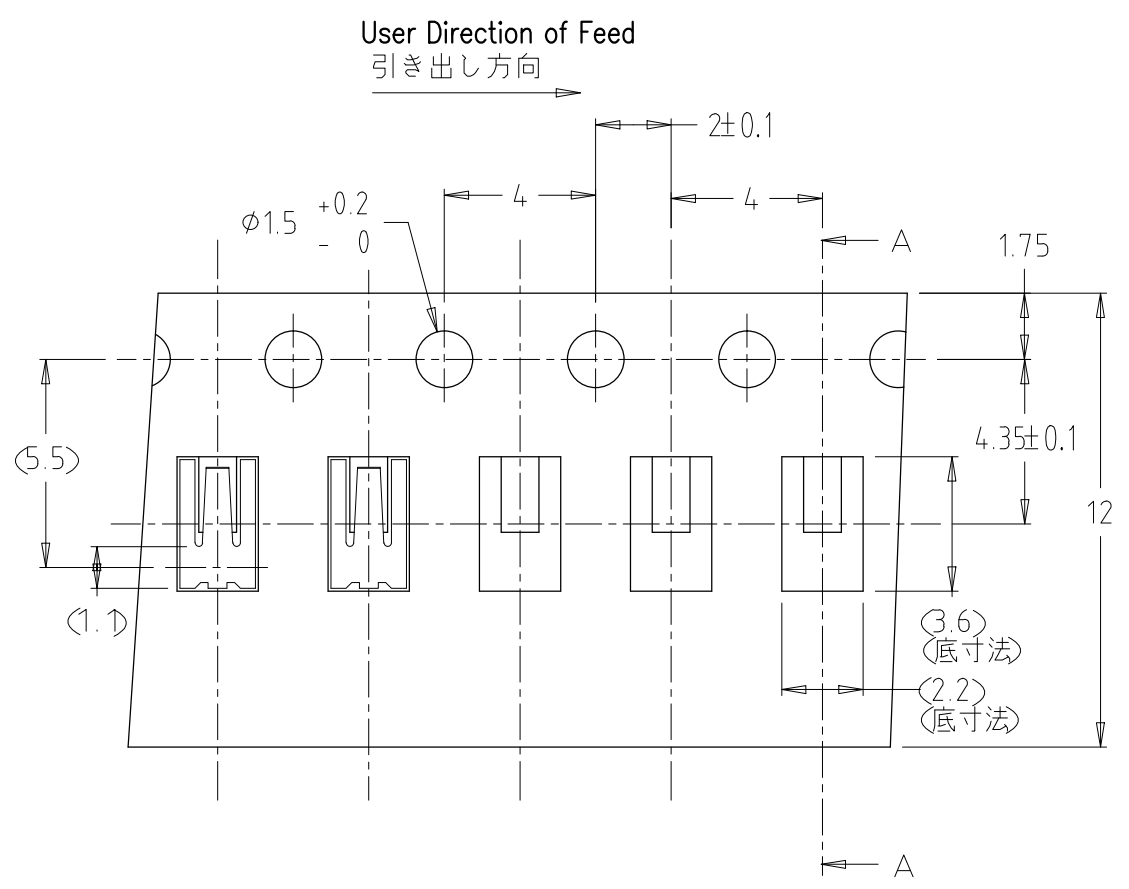

注記
NOTE

1. 一般公差: ± 0.3
1. GENERAL TOLERANCE: ± 0.3
2. 梱包数量: 5,000ケ/リール
2. PACKING STYLE: 5,000pcs/reel
- ③ 材質:
- ③ MATERIAL:

シールドフィンガー: 銅合金(ニッケル下地金めっき 0.05 μ mMIN.)
 SHIELD FINGER: COPPER ALLOY (GOLD-PLATING 0.05 μ m MIN.)
 (SOLDER-PLATING ON THE BOTTOM PLANE ONLY)

キャリアテープ: アクリル系フィルム
 CARRIER TAPE: ACRYLIC FILM
 カバーテープ: PETフィルム
 TOP TAPE: PET FILM
 リール: プラリール
 REEL: PLASTIC

4. リードテープ長さ: 下図参照
4. TAPES DIMENSION

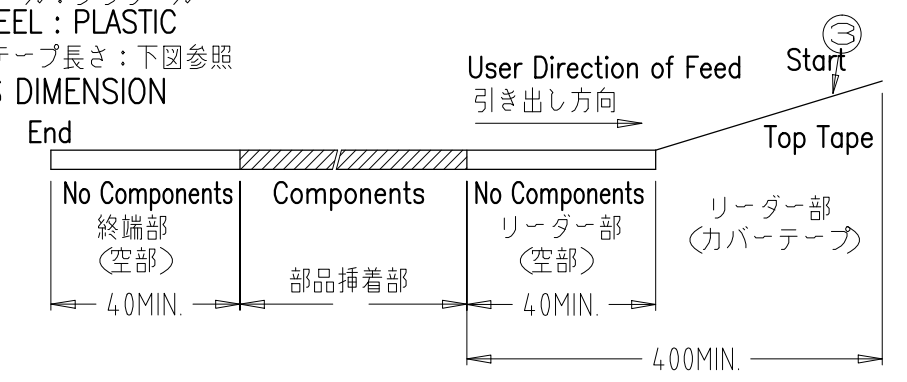

5. リール参考寸法: 下図参照
5. REEL DIMENSION: REFERENCE ONLY

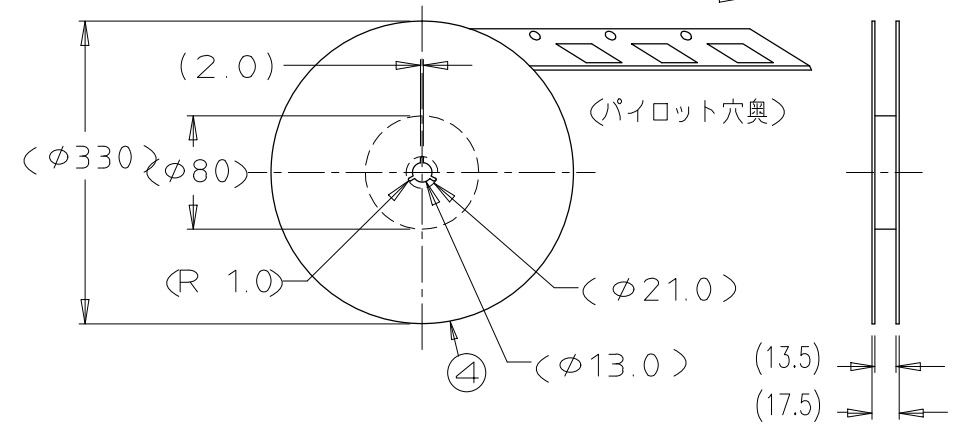

シールドフィンガー0820
SHIELD FINGER 0820

旧型番: 3400089 S=10/1
OLD CAT.NO.340009

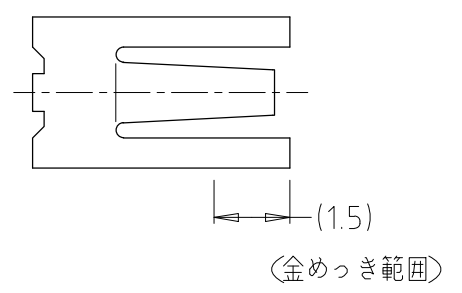
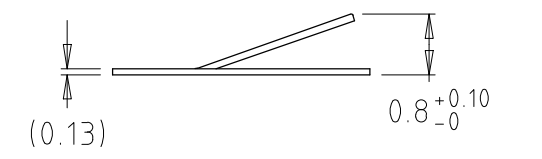
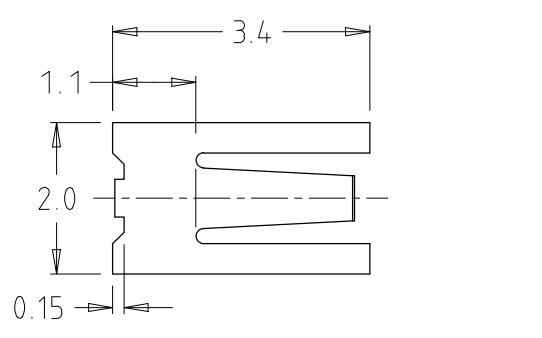

参考パッド寸法 (公差 ± 0.1)
RECOMMENDED FOOT PRINT
REFERENCE ONLY
(GENERAL TOLERANCE: ± 0.1)

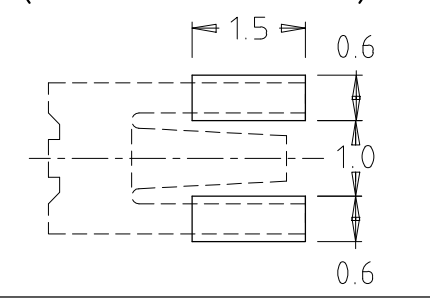

1447009-5	3100029	④	リール	REEL	(旧型番: 3150008)	1
		③	カバーテープ		(旧型番: 3150027)	1
		②	エンボスキャリアテープ	CARRIER TAPE	(旧型番: 3150026)	5000ポケット (部品装着部)
		①	シールドフィンガー0820	SHIELD FINGER 0820	(旧型番: 3400089)	5000ケ
テピング梱包型番	旧テピング梱包型番	No.	名称	型番	数量	
PACKAGING Cat.No.	PACKAGING Cat.No.		DESIGNATION	Cat. No.	QUANTITY	

THIS DRAWING IS A CONTROLLED DOCUMENT.		DWN (K.TAMURA) 19SEP00	TE Connectivity			
DIMENSIONS: mm		CHK T.KUBO 160CT00				
TOLERANCES UNLESS OTHERWISE SPECIFIED:		APVD	NAME			
0 PLC \pm		PRODUCT SPEC	PACKAGING OF SHIELD FINGER 0820 ON CONTINUOUS TAPES			
1 PLC \pm		APPLICATION SPEC	SIZE CAGE CODE DRAWING NO RESTRICTED TO			
2 PLC \pm		WEIGHT	A3 00779 C-1447009-5			
3 PLC \pm			SCALE 5:1 SHEET 1 OF 1 REV P1			
4 PLC \pm						
ANGLES \pm						
FINISH						
MATERIAL $\triangle 3$						