



Chipsmall Limited consists of a professional team with an average of over 10 year of expertise in the distribution of electronic components. Based in Hongkong, we have already established firm and mutual-benefit business relationships with customers from,Europe,America and south Asia,supplying obsolete and hard-to-find components to meet their specific needs.

With the principle of "Quality Parts,Customers Priority,Honest Operation,and Considerate Service",our business mainly focus on the distribution of electronic components. Line cards we deal with include Microchip,ALPS,ROHM,Xilinx,Pulse,ON,Everlight and Freescale. Main products comprise IC,Modules,Potentiometer,IC Socket,Relay,Connector.Our parts cover such applications as commercial,industrial, and automotives areas.

We are looking forward to setting up business relationship with you and hope to provide you with the best service and solution. Let us make a better world for our industry!



## Contact us

Tel: +86-755-8981 8866 Fax: +86-755-8427 6832

Email & Skype: info@chipsmall.com Web: www.chipsmall.com

Address: A1208, Overseas Decoration Building, #122 Zhenhua RD., Futian, Shenzhen, China



## Sensor/actuator box - SACB-6/12-L- 5,0PUR SCO P - 1452660

Please be informed that the data shown in this PDF Document is generated from our Online Catalog. Please find the complete data in the user's documentation. Our General Terms of Use for Downloads are valid (<http://phoenixcontact.com/download>)



Sensor/actuator box, application: Standard, connection method: M12-SPEEDCON-socket Plastic, number of slots: 6, number of positions: 5, coding: A - standard, slot assignment: Double, status display: yes, pnp; master cable connection: Fixed connection 180°, PUR/PVC, cable length: 5 m, shielding: no

### Why buy this product

- Safety in the field, thanks to molded housing and high degree of protection
- Flexible, distributed bundling of signals in one master cable
- Convenient: increased machine availability thanks to quick and easy diagnostics
- Save space: distributor box with double occupancy for two sensors in one slot
- Save time, thanks to installation with SPEEDCON fast locking system



### Key Commercial Data

Packing unit	1 STK
GTIN	 4 046356 553964
GTIN	4046356553964

### Technical data

#### General

Rated voltage	24 V DC
Max. operating voltage $U_{max}$	30 V DC
Current carrying capacity per I/O signal	2 A
Current carrying capacity per slot	4 A
Total rated current	12 A
Number of positions	5
Number of slots	6
Sensor/actuator connection system	M12-SPEEDCON-socket

#### Ambient conditions

Degree of protection	IP65
	IP67

## Sensor/actuator box - SACB-6/12-L- 5,0PUR SCO P - 1452660

### Technical data

#### Ambient conditions

Ambient temperature (operation)	-25 °C ... 80 °C
	-40 °C ... 90 °C (for fixed installation)
	-5 °C ... 80 °C (for flexible installation)

#### Local diagnostics function

Local diagnostics	Supply voltage Green LED
	Status display I/O Yellow LED

#### Master cable connection data

Connection method	Fixed connection
Length of cable	5 m
Tightening torque slot sensor/actuator cable	0.4 Nm
Tightening torque of mounting screw for fixing the housing	0.5 Nm

#### Insulation material

Housing material	PBT
Material of the moulding mass	PUR
Contact material	Cu alloy
Contact surface material	gold-plated
Contact carrier material	PA
Material of threaded sleeve	PBT
O-ring material	NBR

#### Pin assignment

Slot/position = Wire color or connection	1 / 4 (A) = WH
	1 / 2 (B) = GY/PK
	2 / 4 (A) = GN
	2 / 2 (B) = RD/BU
	3 / 4 (A) = YE
	3 / 2 (B) = WH/GN
	4 / 4 (A) = GY
	4 / 2 (B) = BN/GN
	5 / 4 (A) = PK
	5 / 2 (B) = WH/YE
	6 / 4 (A) = RD
	6 / 2 (B) = YE/BN
	1-6 / 1 (+ 24 V) = BN
	1-6 / 3 (0 V) = BU
	1-6 / 5 (PE) = GN/YE

#### Standards and Regulations

Standard designation	M12 connector
Standards/regulations	IEC 61076-2-101

# Sensor/actuator box - SACB-6/12-L- 5,0PUR SCO P - 1452660

## Technical data

### Standards and Regulations

Connection in acc. with standard	CUL
----------------------------------	-----

### Cable

Cable type	PUR/PVC black
Cable type (abbreviation)	PUR
Cable abbreviation	LiYY11Y-HF
UL AWM style	20549
Conductor cross section	12x 0.5 mm <sup>2</sup> (Signal line)
	3x 1 mm <sup>2</sup> (power line)
AWG signal line	20
AWG power supply	17
Conductor structure signal line	28x 0.15 mm
Conductor structure, voltage supply	56x 0.15 mm
Core diameter including insulation	1.5 mm ±0.1 mm (Signal line)
	2.1 mm ±0.1 mm (power line)
Thickness, insulation	≥ 0.15 mm (Inner sheath)
	≥ 0.76 mm (Outer cable sheath)
Wire colors	brown, blue, green/yellow, white, green, yellow, gray, pink, red, gray/pink, red/blue, white/green, brown/green, white/yellow, yellow/brown
Overall twist	Wires twisted in layers
External sheath, color	black RAL 9005
External cable diameter D	9.4 mm ±0.2 mm
Minimum bending radius, fixed installation	7.5 x D
Minimum bending radius, flexible installation	10 x D
Number of bending cycles	1500000
Bending radius	94 mm
Traversing path	2 m
Traversing rate	2 m/s
Cable weight	150.9 kg/km
Outer sheath, material	PUR
Material, inner sheath	PVC
Material conductor insulation	PVC
Conductor material	Bare Cu litz wires
Nominal voltage, cable	300 V
Test voltage, cable	2000 V
Special properties	Silicone-free
Flame resistance	DIN EN 50265
Resistance to oil	according to VDE 0472 Part 803
Other resistance	Highly resistant to acids, alkaline solutions and solvents
Ambient temperature (operation)	-40 °C ... 90 °C (cable, fixed installation)
	-5 °C ... 80 °C (cable, flexible installation)



# Sensor/actuator box - SACB-6/12-L- 5,0PUR SCO P - 1452660

## Technical data

### Environmental Product Compliance

China RoHS	Environmentally friendly use period: unlimited = EFUP-e
	No hazardous substances above threshold values

## Drawings

Schematic diagram

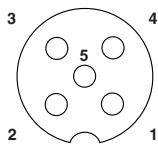

M12 slot, socket, 5-pos.

Cable cross section

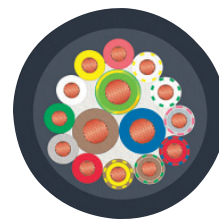

PUR/PVC black [PUR]

Circuit diagram

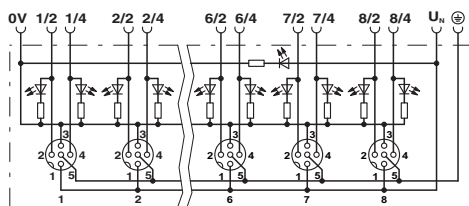

Dimensional drawing

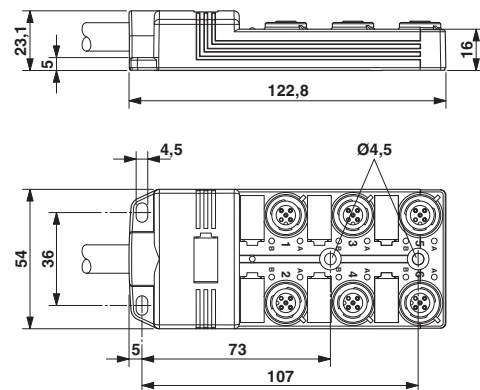

## Approvals

### Approvals

Approvals

UL Recognized / cUL Recognized / EAC / cULus Recognized

Ex Approvals

### Approval details

## Sensor/actuator box - SACB-6/12-L- 5,0PUR SCO P - 1452660

### Approvals

UL Recognized		<a href="http://database.ul.com/cgi-bin/XYV/template/LISEXT/1FRAME/index.htm">http://database.ul.com/cgi-bin/XYV/template/LISEXT/1FRAME/index.htm</a>	FILE E 118976
Nominal voltage UN		24 V	
Nominal current IN		4 A	

cUL Recognized		<a href="http://database.ul.com/cgi-bin/XYV/template/LISEXT/1FRAME/index.htm">http://database.ul.com/cgi-bin/XYV/template/LISEXT/1FRAME/index.htm</a>	FILE E 118976
Nominal voltage UN		24 V	

EAC		EAC-Zulassung
-----	---	---------------

cULus Recognized		<a href="http://database.ul.com/cgi-bin/XYV/template/LISEXT/1FRAME/index.htm">http://database.ul.com/cgi-bin/XYV/template/LISEXT/1FRAME/index.htm</a>
------------------	---	---

Phoenix Contact 2018 © - all rights reserved  
<http://www.phoenixcontact.com>

PHOENIX CONTACT GmbH & Co. KG  
Flachsmarktstr. 8  
32825 Blomberg  
Germany  
Tel. +49 5235 300  
Fax +49 5235 3 41200  
<http://www.phoenixcontact.com>