



Chipsmall Limited consists of a professional team with an average of over 10 year of expertise in the distribution of electronic components. Based in Hongkong, we have already established firm and mutual-benefit business relationships with customers from,Europe,America and south Asia,supplying obsolete and hard-to-find components to meet their specific needs.

With the principle of “Quality Parts,Customers Priority,Honest Operation,and Considerate Service”,our business mainly focus on the distribution of electronic components. Line cards we deal with include Microchip,ALPS,ROHM,Xilinx,Pulse,ON,Everlight and Freescale. Main products comprise IC,Modules,Potentiometer,IC Socket,Relay,Connector.Our parts cover such applications as commercial,industrial, and automotives areas.

We are looking forward to setting up business relationship with you and hope to provide you with the best service and solution. Let us make a better world for our industry!



## Contact us

Tel: +86-755-8981 8866 Fax: +86-755-8427 6832

Email & Skype: info@chipsmall.com Web: www.chipsmall.com

Address: A1208, Overseas Decoration Building, #122 Zhenhua RD., Futian, Shenzhen, China



THIS DRAWING IS UNPUBLISHED. RELEASED FOR PUBLICATION  
 © COPYRIGHT BY TYCO ELECTRONICS CORPORATION. ALL RIGHTS RESERVED.

LOC	DIST	REVISIONS			
P	LTR	DESCRIPTION	DATE	DWN	APVD
DW	-	E	REVISED (ECR-13-000755)	18JAN13	JL WK

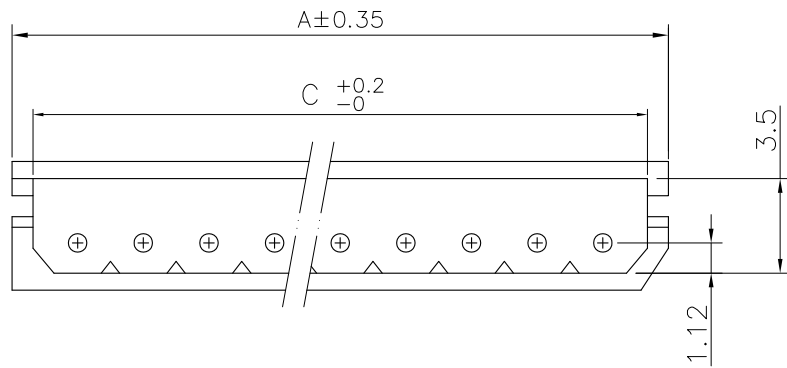
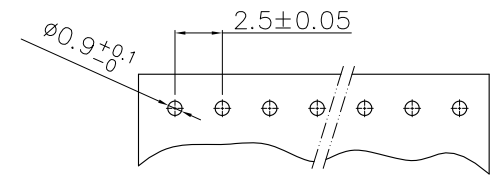
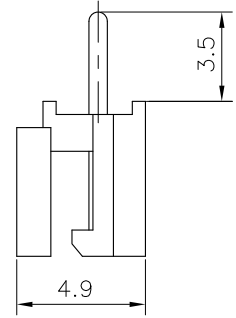
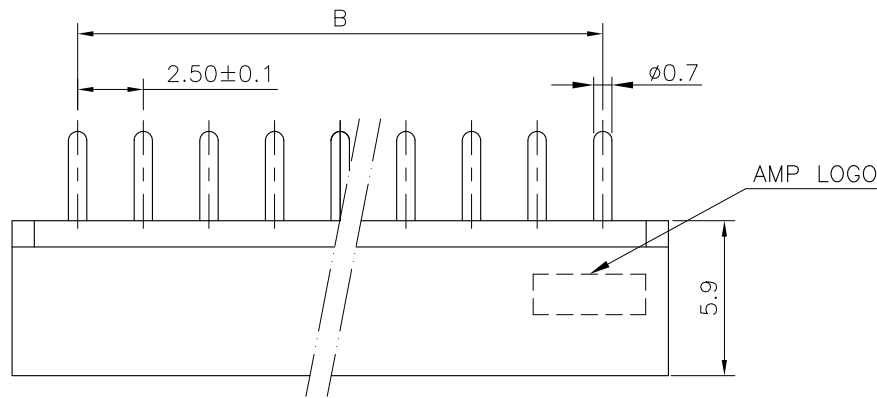

HSG. COLOR	C	B	A	POS.	PART NUMBER
	35.9	32.50 ±0.20	37.5	14	3-1470224-4
	33.4	30.00 ±0.20	35.0	13	3-1470224-3
	30.9	27.50 ±0.20	32.5	12	3-1470224-2
	28.4	25.00 ±0.20	30.0	11	3-1470224-1
	25.9	22.50 ±0.15	27.5	10	3-1470224-0
	23.4	20.00 ±0.15	25.0	9	2-1470224-9
	20.9	17.50 ±0.15	22.5	8	2-1470224-8
	18.4	15.00 ±0.15	20.0	7	2-1470224-7
	15.9	12.50 ±0.10	17.5	6	2-1470224-6
	13.4	10.00 ±0.10	15.0	5	2-1470224-5
	10.9	7.50 ±0.10	12.5	4	2-1470224-4
	8.4	5.00 ±0.10	10.0	3	2-1470224-3
	5.9	2.50 ±0.10	7.5	2	2-1470224-2
	38.4	35.00 ±0.20	40.0	15	1-1470224-5
	35.9	32.50 ±0.20	37.5	14	1-1470224-4
	33.4	30.00 ±0.20	35.0	13	1-1470224-3
	30.9	27.50 ±0.20	32.5	12	1-1470224-2
	28.4	25.00 ±0.20	30.0	11	1-1470224-1
	25.9	22.50 ±0.15	27.5	10	1-1470224-0
	23.4	20.00 ±0.15	25.0	9	0-1470224-9
	20.9	17.50 ±0.15	22.5	8	0-1470224-8
	18.4	15.00 ±0.15	20.0	7	0-1470224-7
	15.9	12.50 ±0.10	17.5	6	0-1470224-6
	13.4	10.00 ±0.10	15.0	5	0-1470224-5
	10.9	7.50 ±0.10	12.5	4	0-1470224-4
	8.4	5.00 ±0.10	10.0	3	0-1470224-3
	5.9	2.50 ±0.10	7.5	2	0-1470224-2

- NOTE:
- MATERIAL:  
HOUSING: PA66, UL 94V-2, COLOR: SEE TABLE.  
CONTACTS: BRASS.
  - FINISH:  
CONTACTS: 1.27µm [50µ"] MIN. BRIGHT-TIN ON SOLDER TAIL, WITH ENTIRE CONTACT UNDERPLATED 0.381µm [15µ"] MIN. NICKEL.
  - WAVE SOLDER CAPABLE TO 240°C PER TE CONNECTIVITY TEST SPEC. 109-202, CONDITION A.
- ⚠️ OBSOLETE PARTS: OBSOLETE CIS STREAMLINING PER D.RENAUD/D.SINISI

THIS DRAWING IS A CONTROLLED DOCUMENT.

DWN O. HU	19DEC2006	 TE Connectivity	2.5mm PITCH EMIX POST HEADER, VERTICAL TYP
CHK S. HOU	19DEC2006		
APVD W.J. KE	19DEC2006		
PRODUCT SPEC	108-57175		
QUALIFICATION TEST REPORT	501-57195	NAME	
MATERIAL SEE NOTE	FINISH SEE NOTE	SIZE	A3
		CAGE CODE	00779
		DRAWING NO	C=1470224
		RESTRICTED TO	-
CUSTOMER DRAWING		SCALE	-
		SHEET	1 OF 2
		REV	E

THIS DRAWING IS UNPUBLISHED.

RELEASED FOR PUBLICATION

-. - .

© COPYRIGHT BY TYCO ELECTRONICS CORPORATION. ALL RIGHTS RESERVED.

LOC	DIST	REVISIONS					
DW	-	P	LTR	DESCRIPTION	DATE	DWN	APVD
		SEE SHEET 1.					

CARTON  
 340mm(L)X470mm(W)X158mm(H)  
 (FOR P/N 0-1470224-2~0-1470224-5)  
 340mm(L)X470mm(W)X316mm(H)  
 (FOR P/N 0-1470224-6~1-1470224-5)

POLY BAG

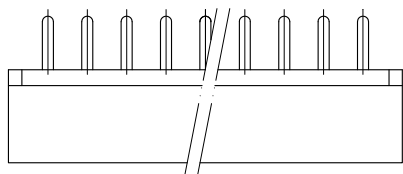
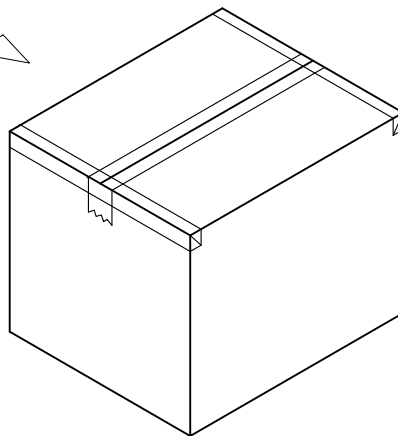
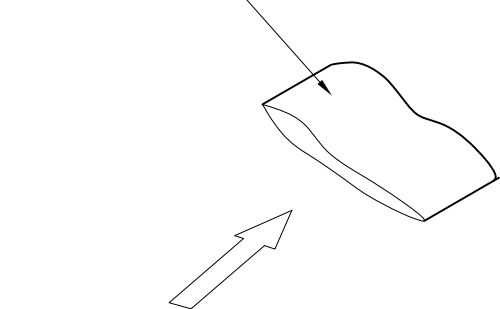

APQ (PCS/CARTON)	PPQ (PCS/BAG)	PART NUMBER	
12,960	180	<del>3-1470224-5</del>	1-1470224-5
12,000	200	<del>3-1470224-4</del>	1-1470224-4
14,400	200	<del>3-1470224-3</del>	1-1470224-3
16,000	250	<del>3-1470224-2</del>	1-1470224-2
16,000	250	<del>3-1470224-1</del>	1-1470224-1
20,000	250	<del>3-1470224-0</del>	1-1470224-0
21,600	300	2-1470224-9	0-1470224-9
25,200	350	2-1470224-8	0-1470224-8
28,000	350	2-1470224-7	0-1470224-7
35,000	350	2-1470224-6	0-1470224-6
20,000	500	2-1470224-5	0-1470224-5
24,000	600	2-1470224-4	0-1470224-4
30,000	750	2-1470224-3	0-1470224-3
36,000	1000	2-1470224-2	0-1470224-2

THIS DRAWING IS A CONTROLLED DOCUMENT.

DWN	O. HU	19DEC2006	 TE Connectivity	2.5mm PITCH EMIX POST HEADER, VERTICAL TYP
CHK	S. HOU	19DEC2006		
APVD	W.J. KE	19DEC2006		
PRODUCT SPEC				
APPLICATION SPEC			NAME	
WEIGHT			SIZE	A3
CUSTOMER DRAWING			CAGE CODE	00779
			DRAWING NO	G=1470224
			RESTRICTED TO	-
			SCALE	-
			SHEET	2 OF 2
			REV	E