



Chipsmall Limited consists of a professional team with an average of over 10 year of expertise in the distribution of electronic components. Based in Hongkong, we have already established firm and mutual-benefit business relationships with customers from,Europe,America and south Asia,supplying obsolete and hard-to-find components to meet their specific needs.

With the principle of “Quality Parts,Customers Priority,Honest Operation,and Considerate Service”,our business mainly focus on the distribution of electronic components. Line cards we deal with include Microchip,ALPS,ROHM,Xilinx,Pulse,ON,Everlight and Freescale. Main products comprise IC,Modules,Potentiometer,IC Socket,Relay,Connector.Our parts cover such applications as commercial,industrial, and automotives areas.

We are looking forward to setting up business relationship with you and hope to provide you with the best service and solution. Let us make a better world for our industry!



## Contact us

Tel: +86-755-8981 8866 Fax: +86-755-8427 6832

Email & Skype: info@chipsmall.com Web: www.chipsmall.com

Address: A1208, Overseas Decoration Building, #122 Zhenhua RD., Futian, Shenzhen, China



## Sensor/actuator box - SACB-8/ 8-C SCO - 1516881

Please be informed that the data shown in this PDF Document is generated from our Online Catalog. Please find the complete data in the user's documentation. Our General Terms of Use for Downloads are valid (<http://phoenixcontact.com/download>)



Sensor/actuator box, application: Standard, connection method: M12-SPEEDCON-socket Metal, number of slots: 8, number of positions: 4, coding: A - standard, slot assignment: single, status display: No, Universal; master cable connection: Pluggable screw connection 180°, shielding: no

### Why buy this product

- Safety in the field, thanks to molded housing and high degree of protection
- Flexible, distributed bundling of signals in one master cable
- Save time, thanks to installation with SPEEDCON fast locking system
- Flexible: distributor box with connector hood for on-site assembly



### Key Commercial Data

Packing unit	1 STK
GTIN	 4 017918 967611
GTIN	4017918967611

### Technical data

#### General

Rated voltage	120 V
Max. operating voltage $U_{max}$	135 V
Current carrying capacity per I/O signal	2 A
Current carrying capacity per slot	4 A
Total rated current	10 A
	2x 8 A (For electrical isolation)
Number of positions	4
Number of slots	8
Flammability rating according to UL 94	V0
Sensor/actuator connection system	M12-SPEEDCON-socket

#### Ambient conditions

Degree of protection	IP65
----------------------	------

# Sensor/actuator box - SACB-8/ 8-C SCO - 1516881

## Technical data

### Ambient conditions

	IP67
	IP69K
Ambient temperature (operation)	-30 °C ... 80 °C

### Master cable data/connection data

Connection method	Pluggable screw connection
Conductor cross section min. (signal)	0.14 mm <sup>2</sup>
Conductor cross section max. (signal)	1.5 mm <sup>2</sup>
Conductor cross section AWG min. (signal)	26
Conductor cross section AWG max. (signal)	16
Stripping length (signal)	7 mm
Conductor cross section min. (energy)	0.14 mm <sup>2</sup>
Conductor cross section max. (energy)	1.5 mm <sup>2</sup>
Conductor cross section AWG min. (energy)	26
Conductor cross section AWG max. (energy)	16
External cable diameter min.	7 mm
External cable diameter max.	12 mm
Stripping length	50 mm (Master cable)
Tightening torque, cover screw	0.35 Nm
Tightening torque, union nut	2.5 Nm
Tightening torque slot sensor/actuator cable	0.4 Nm
Tightening torque of mounting screw for fixing the housing	0.5 Nm

### Insulation material

Housing material	PBT
Material of the moulding mass	PUR
Contact material	Cu alloy
Contact surface material	gold-plated
Contact carrier material	PA
Material of contact, master cable side	CU alloy
Material of contact surface, master cable side	Gold-plated
Material of the contact carrier on the master cable side	PA 6.6 V0
Material of threaded sleeve	Zinc die-cast
Material of threaded sleeve surface	Nickel-plated
O-ring material	NBR

### Pin assignment

Slot/position = Wire color or connection	1 / 4 (A) = 1 / 4
	2 / 4 (A) = 2 / 4
	3 / 4 (A) = 3 / 4
	4 / 4 (A) = 4 / 4
	5 / 4 (A) = 5 / 4

# Sensor/actuator box - SACB-8/ 8-C SCO - 1516881

## Technical data

### Pin assignment

	6 / 4 (A) = 6 / 4
	7 / 4 (A) = 7 / 4
	8 / 4 (A) = 8 / 4
	1-8 / 1 (+ 120 V) = U <sub>N</sub>
	1-8 / 3 (0 V) = 0 V
	1-8 / 5 (PE) = PE

### Standards and Regulations

Standard designation	M12 connector
Standards/regulations	IEC 61076-2-101
Connection in acc. with standard	CUL
Flammability rating according to UL 94	V0

### Environmental Product Compliance

REACH SVHC	Lead 7439-92-1
China RoHS	Environmentally Friendly Use Period = 50
	For details about hazardous substances go to tab "Downloads", Category "Manufacturer's declaration"

## Drawings

Schematic diagram

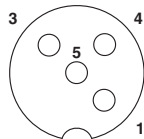

M12 slot, socket, 4-pos.

Schematic diagram

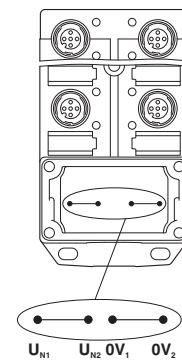

Potential U<sub>N1</sub> and U<sub>N2</sub> bridged. Potential assignment: U<sub>N1</sub> = U<sub>N2</sub> = slots 1,2,3,4,5,6,7,8.

# Sensor/actuator box - SACB-8/ 8-C SCO - 1516881

Schematic diagram

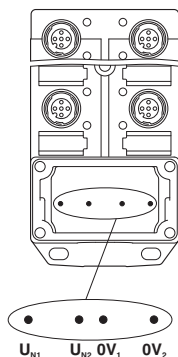

Dimensional drawing

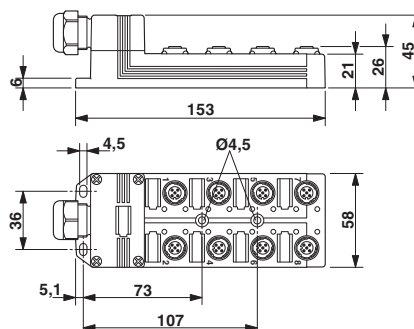

Electrically isolated. Potential assignment:  $U_{N1}$  = slots 1,3,5,7 and  $U_{N2}$  = slots 2,4,6,8.

Circuit diagram

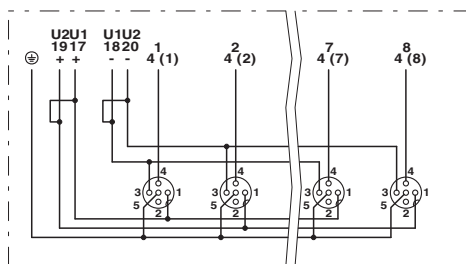

## Approvals

Approvals

Approvals

UL Recognized / cUL Recognized / EAC / cULus Recognized

Ex Approvals

## Approval details

UL Recognized		<a href="http://database.ul.com/cgi-bin/XYVV/template/LISEXT/1FRAME/index.htm">http://database.ul.com/cgi-bin/XYVV/template/LISEXT/1FRAME/index.htm</a>	FILE E 118976
Nominal voltage UN		120 V	

## Sensor/actuator box - SACB-8/ 8-C SCO - 1516881

### Approvals

Nominal current IN	3 A
--------------------	-----

cUL Recognized		<a href="http://database.ul.com/cgi-bin/XYV/template/LISEXT/1FRAME/index.htm">http://database.ul.com/cgi-bin/XYV/template/LISEXT/1FRAME/index.htm</a>	FILE E 118976
Nominal voltage UN	120 V		
Nominal current IN	3 A		

EAC		RU C- DE.AI30.B.01102
-----	---	--------------------------

cULus Recognized		<a href="http://database.ul.com/cgi-bin/XYV/template/LISEXT/1FRAME/index.htm">http://database.ul.com/cgi-bin/XYV/template/LISEXT/1FRAME/index.htm</a>
------------------	---	---

Phoenix Contact 2018 © - all rights reserved  
<http://www.phoenixcontact.com>

PHOENIX CONTACT GmbH & Co. KG  
Flachsmarktstr. 8  
32825 Blomberg  
Germany  
Tel. +49 5235 300  
Fax +49 5235 3 41200  
<http://www.phoenixcontact.com>