



Chipsmall Limited consists of a professional team with an average of over 10 year of expertise in the distribution of electronic components. Based in Hongkong, we have already established firm and mutual-benefit business relationships with customers from,Europe,America and south Asia,supplying obsolete and hard-to-find components to meet their specific needs.

With the principle of “Quality Parts,Customers Priority,Honest Operation,and Considerate Service”,our business mainly focus on the distribution of electronic components. Line cards we deal with include Microchip,ALPS,ROHM,Xilinx,Pulse,ON,Everlight and Freescale. Main products comprise IC,Modules,Potentiometer,IC Socket,Relay,Connector.Our parts cover such applications as commercial,industrial, and automotives areas.

We are looking forward to setting up business relationship with you and hope to provide you with the best service and solution. Let us make a better world for our industry!



Contact us

Tel: +86-755-8981 8866 Fax: +86-755-8427 6832

Email & Skype: info@chipsmall.com Web: www.chipsmall.com

Address: A1208, Overseas Decoration Building, #122 Zhenhua RD., Futian, Shenzhen, China



Sensor/actuator box - SACB- 4/3-L-C QO-0,34 - 1548325

Please be informed that the data shown in this PDF Document is generated from our Online Catalog. Please find the complete data in the user's documentation. Our General Terms of Use for Downloads are valid (<http://download.phoenixcontact.com>)



Sensor/actuator box, Connection method: QUICKON, 0.14 mm² ... 0.34 mm², Number of slots: 4, Number of positions: 3, Slot assignment: Single, Status indication: Yes, pnp; Master cable connection: Pluggable screw connection 180°, Shielding: No

Product Features

- ✓ Safety in the field, thanks to molded housing and high degree of protection
- ✓ Flexible, distributed bundling of signals in one master cable
- ✓ Convenient: increased machine availability thanks to quick and easy diagnostics
- ✓ Innovative and time-saving assembly with insulation displacement connection
- ✓ Flexible: distributor box with connector hood for on-site assembly



Key commercial data

Packing unit	1 PCE
Weight per Piece (excluding packing)	251.2 GRM
Custom tariff number	85366990
Country of origin	Poland

Technical data

General

Rated voltage	24 V DC
Max. operating voltage U _{max}	30 V DC
Current carrying capacity per I/O signal	2 A
Current carrying capacity per slot	4 A
Total rated current	10 A
	2x 8 A (For electrical isolation)
Number of positions	3
Number of slots	4
Inflammability class according to UL 94	V0
Sensor/actuator connection system	QUICKON

Sensor/actuator box - SACB- 4/3-L-C QO-0,34 - 1548325

Technical data

Ambient conditions

Degree of protection	IP65
	IP67
	IP69K
Ambient temperature (operation)	-30 °C ... 80 °C

Local diagnostics function

Local diagnostics	Supply voltage per module Green LED
	Status display I/O Yellow LED

Master cable data/connection data

Connection method	Pluggable screw connection
Conductor cross section min. (signal)	0.14 mm ²
Conductor cross section max. (signal)	1.5 mm ²
Conductor cross section AWG min. (signal)	26
Conductor cross section AWG max. (signal)	16
Stripping length (signal)	7 mm
Conductor cross section min. (energy)	0.14 mm ²
Conductor cross section max. (energy)	1.5 mm ²
Conductor cross section AWG min. (energy)	26
Conductor cross section AWG max. (energy)	16
External cable diameter min.	7 mm
External cable diameter max.	12 mm
Stripping length	50 mm (Master cable)
Tightening torque, cover screw	0.35 Nm
Tightening torque, union nut	2.5 Nm

Conductor data

Structure of individual litz in acc. with VDE 0295 / smallest wire diameter	Class 2-6
Wire insulation material	PVC/PE/PP
Wire diameter including insulation	0.7 mm ... 1.3 mm
Minimum external conductor diameter	3.5 mm
Maximum external conductor diameter	6 mm
Tightening torque, union nut	2 Nm
Wrench size, union nut	13 mm
Conductor cross section stranded min.	0.14 mm ²
Conductor cross section stranded max.	0.34 mm ²
Conductor cross section AWG/kcmil min.	26
Conductor cross section AWG/kcmil max	22

Sensor/actuator box - SACB- 4/3-L-C QO-0,34 - 1548325

Technical data

Insulation material

Housing material	PBT
Material of the moulding mass	PUR
Contact material	Steel/copper
Contact surface material	Sn
Material of contact, master cable side	CU alloy
Material of contact surface, master cable side	Gold-plated
Material of the contact carrier on the master cable side	PA 66 V0

Pin assignment

Slot/position = Wire color or connection	1 / 4 (A) = 1 / 4
	2 / 4 (A) = 2 / 4
	3 / 4 (A) = 3 / 4
	4 / 4 (A) = 4 / 4
	1-4 / 1 (+ 24 V) = U _N
	1-4 / 3 (0 V) = 0 V

Classifications

eCl@ss

eCl@ss 4.0	27250313
eCl@ss 4.1	27250313
eCl@ss 5.0	27143423
eCl@ss 5.1	27143423
eCl@ss 6.0	27143423
eCl@ss 7.0	27449001
eCl@ss 8.0	27449001

ETIM

ETIM 3.0	EC001856
ETIM 4.0	EC002585
ETIM 5.0	EC002585

UNSPSC

UNSPSC 6.01	31261501
UNSPSC 7.0901	31261501
UNSPSC 11	31261501
UNSPSC 12.01	31261501
UNSPSC 13.2	31261501

Sensor/actuator box - SACB- 4/3-L-C QO-0,34 - 1548325

Approvals

Approvals

Approvals

UL Recognized / cUL Recognized / GOST / cULus Recognized

Ex Approvals

Approvals submitted

Approval details

UL Recognized 	
Nominal voltage UN	24 V

cUL Recognized 	
Nominal voltage UN	24 V

GOST 	
--	--

cULus Recognized 	
--	--

Accessories

Accessories

Cable by the meter

Sensor/actuator box - SACB- 4/3-L-C QO-0,34 - 1548325

Accessories

Master cable ring - SACB- 4X0,34/2X0,75-50 PUR - 1517576



Master cable for sensor/actuator boxes, without PE conductor, unshielded, material PUR/PVC, 6-pos., 4 x 0.34 mm² and 2 x 0.75 mm², length: 50 m

Connector hood without master cable

Connector hood - SACB-C-H180 8/4 QO-0,34 - 1560235



Connector hood, For use in Sensor/actuator box, Connection method: QUICKON, Number of slots: 8, Slot assignment: Double, Status indication: No; Master cable connection: Pluggable screw connection 180°, Shielding: No

Device marking

Contact marker – zack marker strip - SS-ZB 17,5 WH - 0804963



Contact marker – zack marker strip, Strip, white, Unlabeled, Can be labeled with: Plotter, Mounting type: Snap into flat marker groove, Lettering field: 17.5 x 8 mm

Pressure nut

Connector - QO-SET - 1548626



QUICKON set for replacement purposes, consisting of splice ring, pressure nut and line seal

Protective cap

Sensor/actuator box - SACB- 4/3-L-C QO-0,34 - 1548325

Accessories

Filler plugs - Q-PROT 9/11 - 1670235



Closing cap for Pg9/Pg11 to close unoccupied connections

Screwdriver tools

Philips screwdriver - SZK PZ1 VDE - 1206450



Screwdriver, PZ crosshead, VDE insulated, size: PZ 1 x 80 mm, 2-component grip, with non-slip grip

Tool - SAC BIT QUICKON-W13 - 1212033



Nut for assembling QUICKON pressure nuts with 13 mm wrench size, for 4 mm hexagonal drive

Torque tool

Torque screwdriver - TSD 20 SAC - 1212020



Torque screwdriver, with preset torque of 2.0 Nm and 4 mm hexagonal drive for the pressure nut of the fast connection

Drawings

Sensor/actuator box - SACB- 4/3-L-C QO-0,34 - 1548325

Schematic diagram

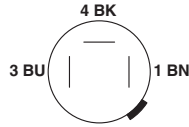

QUICKON connection, 3-pos.

Schematic diagram

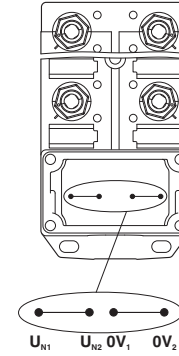

Potential U_{N1} and U_{N2} bridged. Potential assignment: $U_{N1} = U_{N2} = \text{slots } 1,2,3,4.$

Schematic diagram

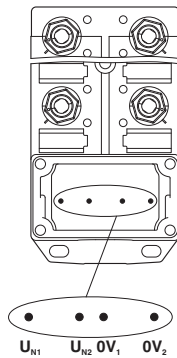

Electrically isolated. Potential assignment: $U_{N1} = \text{slots } 1,3$ and $U_{N2} = \text{slots } 2,4.$

Dimensioned drawing

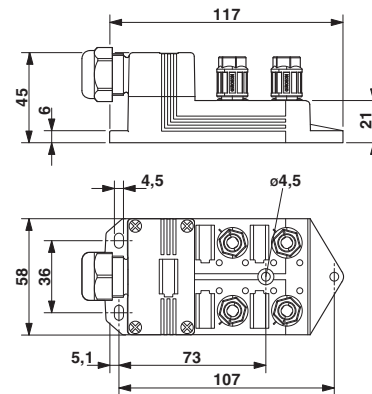

Circuit diagram

