



Chipsmall Limited consists of a professional team with an average of over 10 year of expertise in the distribution of electronic components. Based in Hongkong, we have already established firm and mutual-benefit business relationships with customers from,Europe,America and south Asia,supplying obsolete and hard-to-find components to meet their specific needs.

With the principle of “Quality Parts,Customers Priority,Honest Operation,and Considerate Service”,our business mainly focus on the distribution of electronic components. Line cards we deal with include Microchip,ALPS,ROHM,Xilinx,Pulse,ON,Everlight and Freescale. Main products comprise IC,Modules,Potentiometer,IC Socket,Relay,Connector.Our parts cover such applications as commercial,industrial, and automotives areas.

We are looking forward to setting up business relationship with you and hope to provide you with the best service and solution. Let us make a better world for our industry!



Contact us

Tel: +86-755-8981 8866 Fax: +86-755-8427 6832

Email & Skype: info@chipsmall.com Web: www.chipsmall.com

Address: A1208, Overseas Decoration Building, #122 Zhenhua RD., Futian, Shenzhen, China





N-Channel 80- and 90-V (D-S) MOSFETs

PRODUCT SUMMARY				
Part Number	V _{(BR)DSS} Min (V)	r _{DS(on)} Max (Ω)	V _{GS(th)} (V)	I _D (A)
VN0808L	80	4 @ V _{GS} = 10 V	0.8 to 2	0.3
VN0808LS		4 @ V _{GS} = 10 V	0.8 to 2	0.33
VQ1006P	90	4 @ V _{GS} = 10 V	0.8 to 2.5	0.4

FEATURES

- Low On-Resistance: 3.6 Ω
- Low Threshold: 1.6 V
- Low Input Capacitance: 35 pF
- Fast Switching Speed: 6 ns
- Low Input and Output Leakage

BENEFITS

- Low Offset Voltage
- Low-Voltage Operation
- Easily Driven Without Buffer
- High-Speed Circuits
- Low Error Voltage

APPLICATIONS

- Direct Logic-Level Interface: TTL/CMOS
- Drivers: Relays, Solenoids, Lamps, Hammers, Displays, Memories, Transistors, etc.
- Battery Operated Systems
- Solid-State Relays

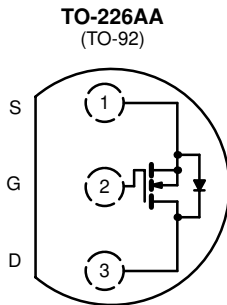

Top View
VN0808L

Front View:
VN0808L

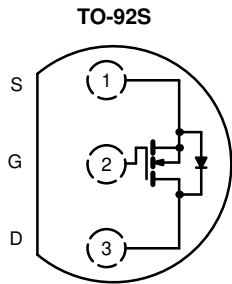
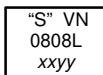

Top View
VN0808LS

Front View:

VN0808LS

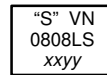

"S" = Siliconix Logo
f = Factory Code
ll = Lot Traceability
xxyy = Date Code

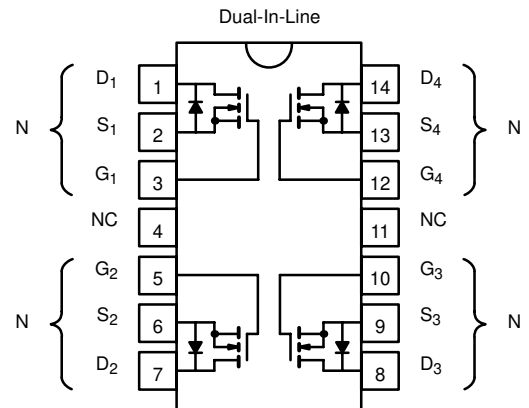

Top View
Sidebrazed: VQ1006P

Top View:

VQ1006P

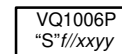

ABSOLUTE MAXIMUM RATINGS (T _A = 25°C UNLESS OTHERWISE NOTED)							
Parameter	Symbol	VN0808L	VN0808LS	VQ1006P		Unit	
				Single	Total Quad		
Drain-Source Voltage	V _{DS}	80	80	90		V	
Gate-Source Voltage	V _{GS}	±30	±30	±20			
Continuous Drain Current (T _J = 150°C)	I _D	T _A = 25°C	0.3	0.33	0.4		A
		T _A = 100°C	0.19	0.21	0.23		
Pulsed Drain Current ^a	I _{DM}	1.9	1.9	2			
Power Dissipation	P _D	T _A = 25°C	0.8	0.9	1.3	2	W
		T _A = 100°C	0.32	0.4	0.52	0.8	
Thermal Resistance, Junction-to-Ambient	R _{thJA}	156	139	96	62.5	°C/W	
Operating Junction and Storage Temperature Range	T _J , T _{stg}	-55 to 150					°C

Notes

a. Pulse width limited by maximum junction temperature.

SPECIFICATIONS ($T_A = 25^\circ\text{C}$ UNLESS OTHERWISE NOTED)								
Parameter	Symbol	Test Conditions	Typ ^a	Limits				Unit
				VN0808L/LS		VQ1006P		
				Min	Max	Min	Max	
Static								
Drain-Source Breakdown Voltage	$V_{(BR)DSS}$	$V_{GS} = 0\text{ V}, I_D = 10\ \mu\text{A}$	125	80		90		V
Gate-Threshold Voltage	$V_{GS(th)}$	$V_{DS} = V_{GS}, I_D = 1\ \text{mA}$	1.6	0.8	2	0.8	2.5	
Gate-Body Leakage	I_{GSS}	$V_{DS} = 0\ \text{V}, V_{GS} = \pm 15\ \text{V}$			± 100		± 100	nA
							± 500	
Zero Gate Voltage Drain Current	I_{DSS}	$V_{DS} = 80\ \text{V}, V_{GS} = 0\ \text{V}$			10			μA
					500			
							1	
		$V_{DS} = 72\ \text{V}, V_{GS} = 0\ \text{V}$					500	
		$T_J = 125^\circ\text{C}$						
On-State Drain Current ^b	$I_{D(on)}$	$V_{DS} = 10\ \text{V}, V_{GS} = 10\ \text{V}$	1.8	1.5		1.5		A
Drain-Source On-Resistance ^b	$r_{DS(on)}$	$V_{GS} = 5\ \text{V}, I_D = 0.3\ \text{A}$	3.8				5	Ω
					4		4.5	
					8		8.6	
		$T_J = 125^\circ\text{C}$	6.7					
Forward Transconductance ^b	g_{fs}	$V_{DS} = 10\ \text{V}, I_D = 0.5\ \text{A}$	350	170		170		mS
Common Source Output Conductance ^b	g_{os}	$V_{DS} = 10\ \text{V}, I_D = 0.1\ \text{A}$	0.23					
Dynamic								
Input Capacitance	C_{iss}	$V_{DS} = 25\ \text{V}, V_{GS} = 0\ \text{V}, f = 1\ \text{MHz}$	35		50		60	pF
Output Capacitance	C_{oss}		15		40		50	
Reverse Transfer Capacitance	C_{rss}		2		10		10	
Switching^c								
Turn-On Time	t_{ON}	$V_{DD} = 25\ \text{V}, R_L = 23\ \Omega$ $I_D \cong 1\ \text{A}, V_{GEN} = 10\ \text{V}$ $R_G = 25\ \Omega$	6		10		10	ns
Turn-Off Time	t_{OFF}		8		10		10	

Notes

- a. For DESIGN AID ONLY, not subject to production testing.
 b. Pulse test: $PW \leq 300\ \mu\text{s}$ duty cycle $\leq 2\%$.
 c. Switching time is essentially independent of operating temperature.

VNDQ09



TYPICAL CHARACTERISTICS (T_A = 25°C UNLESS OTHERWISE NOTED)

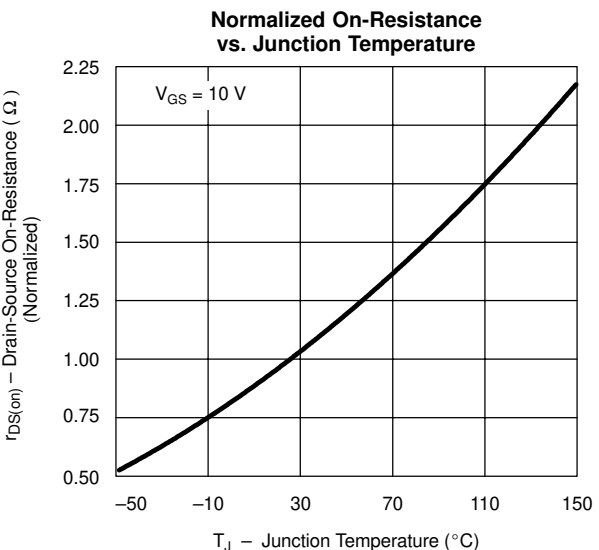
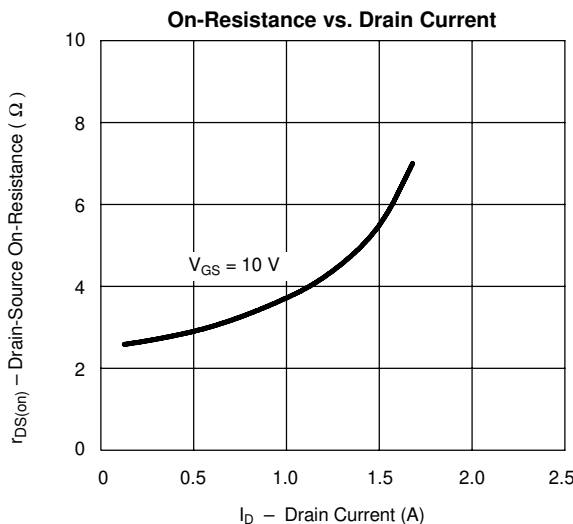
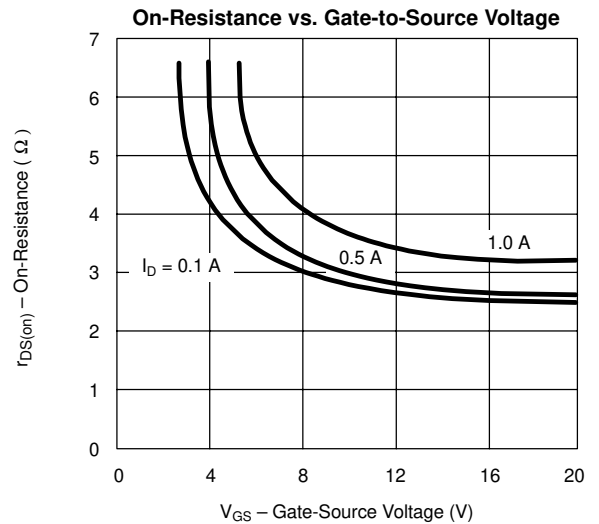
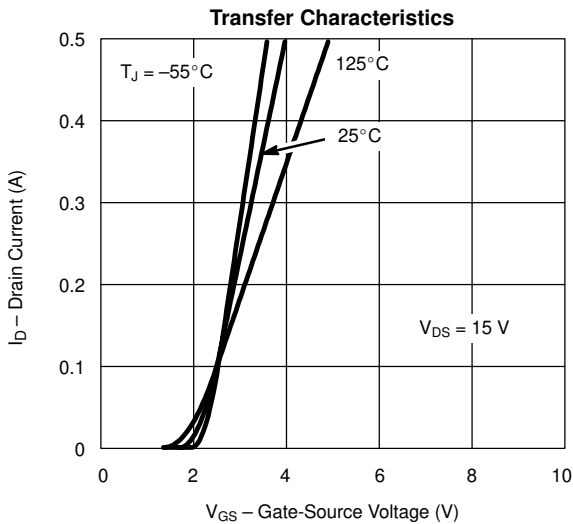
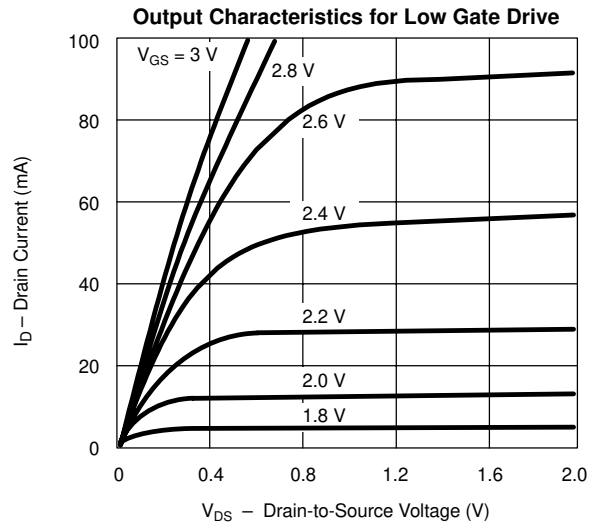
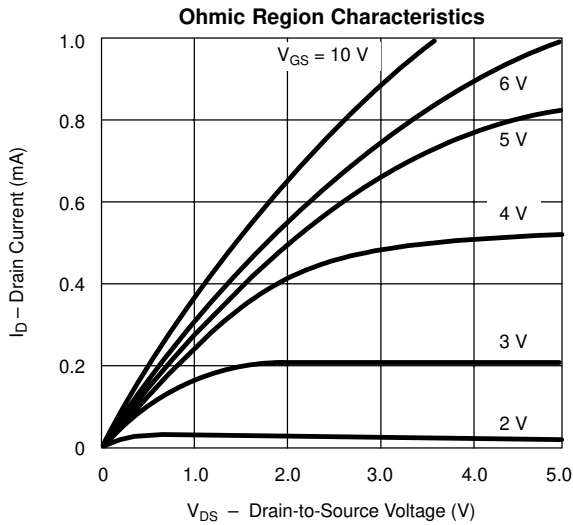

TYPICAL CHARACTERISTICS ($T_A = 25^\circ\text{C}$ UNLESS OTHERWISE NOTED)

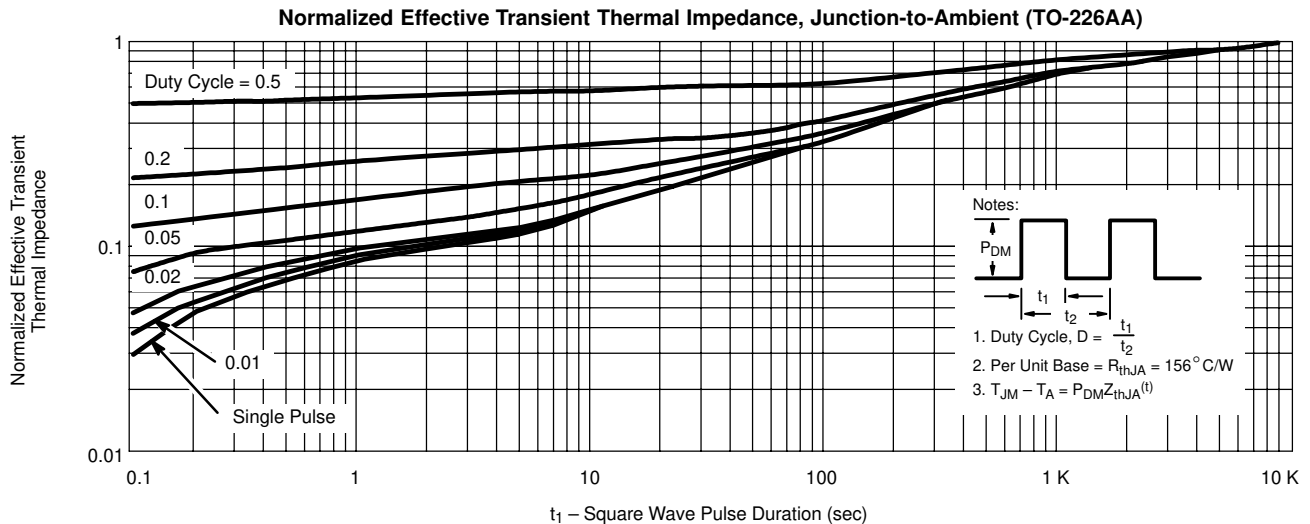
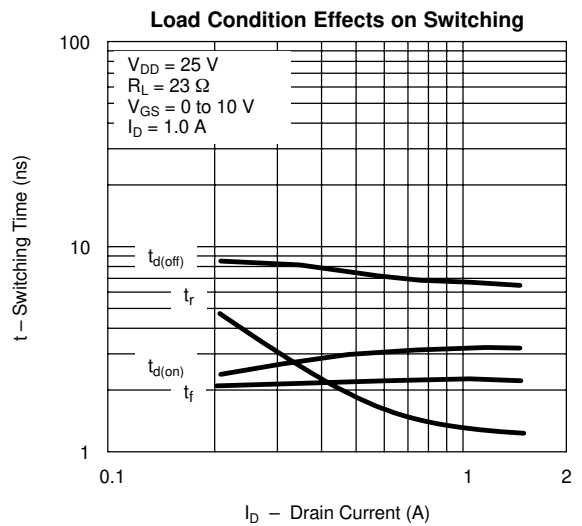
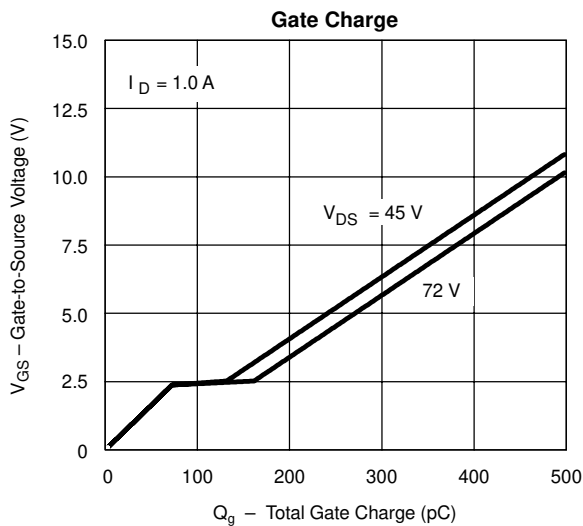
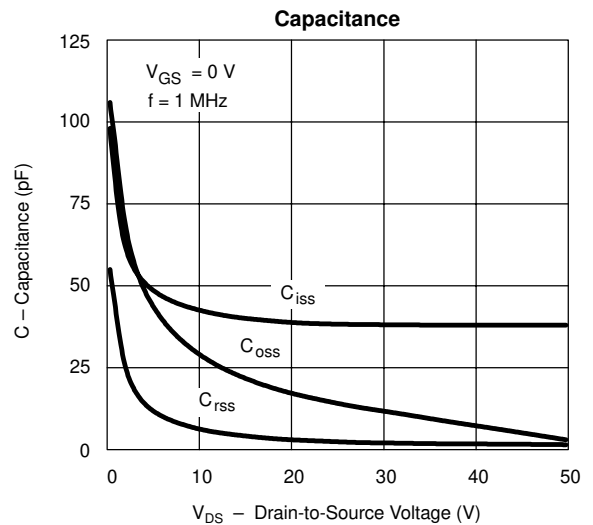
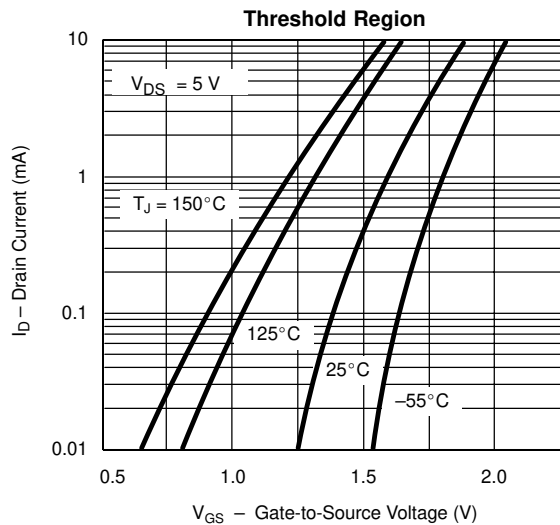



Disclaimer

All product specifications and data are subject to change without notice.

Vishay Intertechnology, Inc., its affiliates, agents, and employees, and all persons acting on its or their behalf (collectively, "Vishay"), disclaim any and all liability for any errors, inaccuracies or incompleteness contained herein or in any other disclosure relating to any product.

Vishay disclaims any and all liability arising out of the use or application of any product described herein or of any information provided herein to the maximum extent permitted by law. The product specifications do not expand or otherwise modify Vishay's terms and conditions of purchase, including but not limited to the warranty expressed therein, which apply to these products.

No license, express or implied, by estoppel or otherwise, to any intellectual property rights is granted by this document or by any conduct of Vishay.

The products shown herein are not designed for use in medical, life-saving, or life-sustaining applications unless otherwise expressly indicated. Customers using or selling Vishay products not expressly indicated for use in such applications do so entirely at their own risk and agree to fully indemnify Vishay for any damages arising or resulting from such use or sale. Please contact authorized Vishay personnel to obtain written terms and conditions regarding products designed for such applications.

Product names and markings noted herein may be trademarks of their respective owners.