



Chipsmall Limited consists of a professional team with an average of over 10 year of expertise in the distribution of electronic components. Based in Hongkong, we have already established firm and mutual-benefit business relationships with customers from,Europe,America and south Asia,supplying obsolete and hard-to-find components to meet their specific needs.

With the principle of “Quality Parts,Customers Priority,Honest Operation,and Considerate Service”,our business mainly focus on the distribution of electronic components. Line cards we deal with include Microchip,ALPS,ROHM,Xilinx,Pulse,ON,Everlight and Freescale. Main products comprise IC,Modules,Potentiometer,IC Socket,Relay,Connector.Our parts cover such applications as commercial,industrial, and automotives areas.

We are looking forward to setting up business relationship with you and hope to provide you with the best service and solution. Let us make a better world for our industry!



## Contact us

Tel: +86-755-8981 8866 Fax: +86-755-8427 6832

Email & Skype: info@chipsmall.com Web: www.chipsmall.com

Address: A1208, Overseas Decoration Building, #122 Zhenhua RD., Futian, Shenzhen, China



# 1591XXT Enclosure

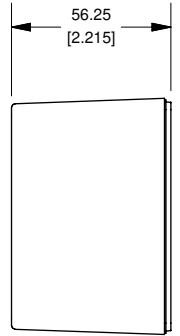

END VIEW OF BOX

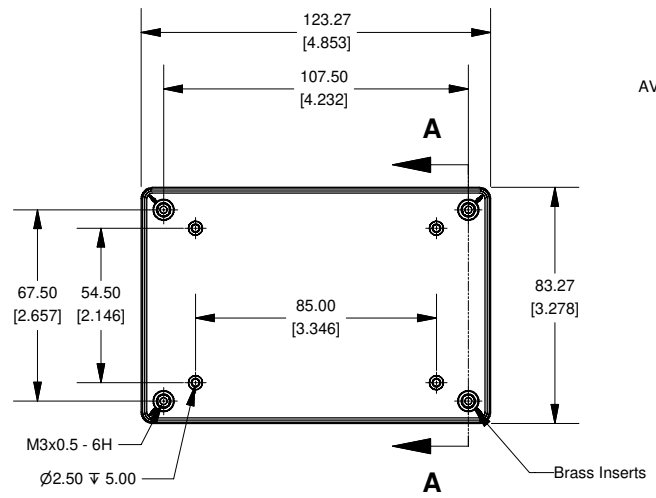

TOP VIEW OF BOX

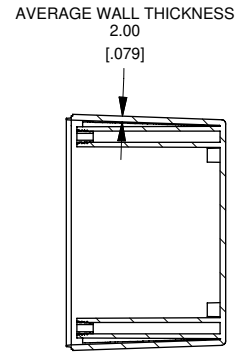

SECTION A-A

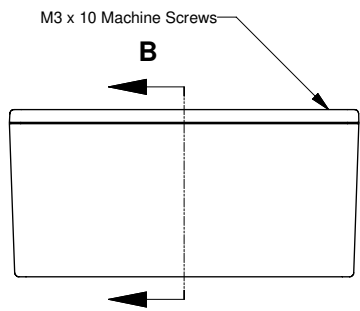

SIDE VIEW OF ENCLOSURE

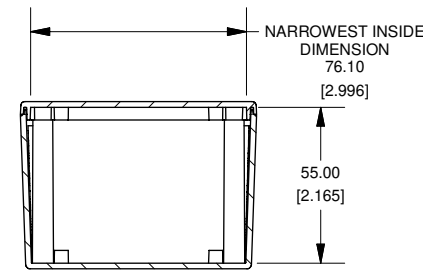

SECTION B-B

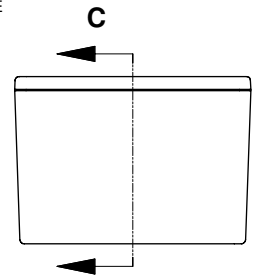

END VIEW OF ENCLOSURE

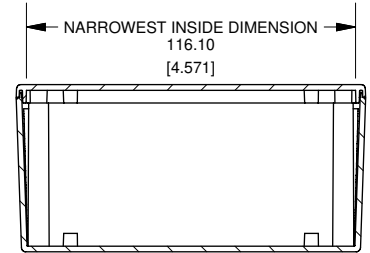

SECTION C-C

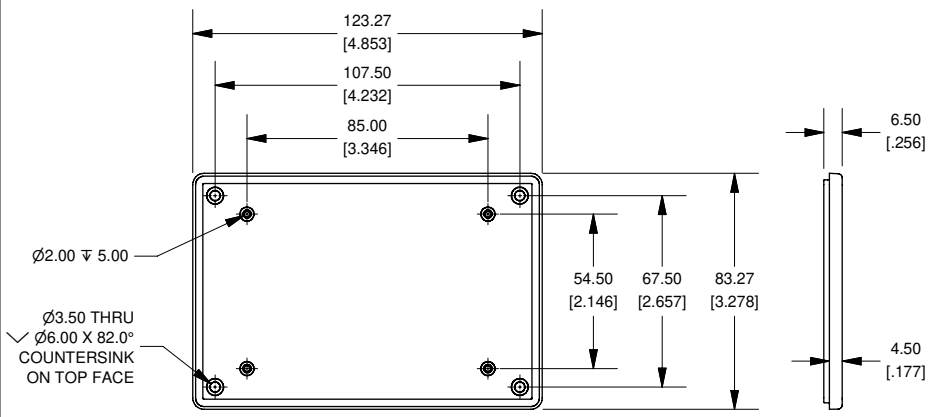

BOTTOM VIEW OF LID

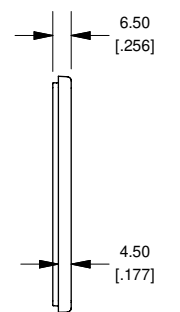

SIDE VIEW OF LID

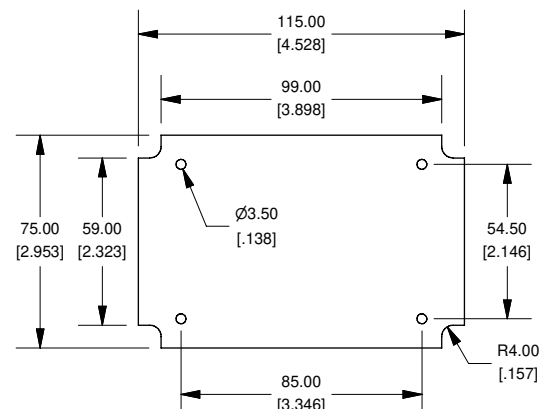

Max Size PCB. Fits in Box or in Lid.  
Not supplied with Enclosure

**NOTE:**

Enclosures available modified, Milling, Drilling, Silk Screening.  
Solid models of this enclosure available in STEP or IGES.  
Contact Factory [mjm@hammondmfg.com](mailto:mjm@hammondmfg.com)

NOTE	
Enclosure molded from FRABS UL 94-V0 Plastic. Other materials / Colours Available Consult Factory	
1591XXT	
1590XXT Enclosure	
Black Enclosure - RAL 7011	1591XXTBK
Gray Enclosure - RAL 7035	1591XXTGY
ACCESSORIES	
For Flame Retardent ABS (UL94-V0)	
Black Enclosure Cover Screws (Pkg 100)	1591MS100BK
Gray Enclosure Cover Screws (Pkg 100)	1591MS100
P.C. Board Screws (All Boxes)	
P.C. Board Screws	1593ATS50 (Pkg 50)
#4 x 1/4" self-tapping (6.4mm)	1593ATS100 (Pkg 100)

