



Chipsmall Limited consists of a professional team with an average of over 10 year of expertise in the distribution of electronic components. Based in Hongkong, we have already established firm and mutual-benefit business relationships with customers from,Europe,America and south Asia,supplying obsolete and hard-to-find components to meet their specific needs.

With the principle of “Quality Parts,Customers Priority,Honest Operation,and Considerate Service”,our business mainly focus on the distribution of electronic components. Line cards we deal with include Microchip,ALPS,ROHM,Xilinx,Pulse,ON,Everlight and Freescale. Main products comprise IC,Modules,Potentiometer,IC Socket,Relay,Connector.Our parts cover such applications as commercial,industrial, and automotives areas.

We are looking forward to setting up business relationship with you and hope to provide you with the best service and solution. Let us make a better world for our industry!



Contact us

Tel: +86-755-8981 8866 Fax: +86-755-8427 6832

Email & Skype: info@chipsmall.com Web: www.chipsmall.com

Address: A1208, Overseas Decoration Building, #122 Zhenhua RD., Futian, Shenzhen, China



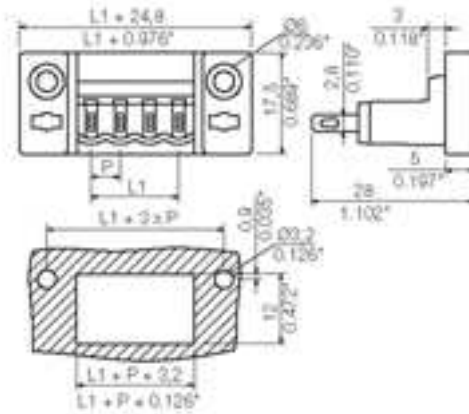

General ordering data

Order No.	1599130000
Part designation	SLDF 5.08 L/F 2 SN OR
Version	PCB plug-in connector, Male connectors, Pitch: 5.08 mm, No. of poles: 2, 180°, Box
EAN	4008190175931
Qty.	100 pc(s).

System parameters

Outgoing direction of conductor	180°
Pitch	5.08 mm
Pitch in inch	0.2 inch
No. of poles	2
L1 in mm	5.08 mm
L1 in inch	0.2 inch

Material data

Insulating material	PBT
Colour	orange
colour chart	Similar to RAL 2000
Flammability class UL 94	V-0
Contact base material	CuSn
Contact surface	tinned

DIN IEC rating data

Rated current, min. No. pins (Tu=20°C)	15 A
Rated current, min. No. pins(Tu=40°C)	13 A
Rated voltage for overvoltage class/pollution severity II/2	400 V
Rated voltage for overvoltage class/pollution severity III/2	320 V
Rated voltage for overvoltage class/pollution severity III/3	250 V
Rated impulse withstand voltage for overvoltage class/pollution severity II/2	4 kV
Rated impulse withstand voltage for overvoltage class/pollution severity III/2	4 kV
Rated impulse withstand voltage for overvoltage class/pollution severity III/3	4 kV

CSA rating data

Rated voltage (Use group D)	300 V
Rated current (Use group D)	10 A

UL 1059 rating data

Rated voltage (Use group D)	300 V
Rated current (Use group D)	10 A

Approvals

Approvals institutes



Classifications

ETIM 2.0	NK
ETIM 3.0	EC001284
eClass 4.1	27-26-07-01
eClass 5.0	27-26-07-01
eClass 5.1	27-26-07-04

Similar products

Order No.	Part designation	Version
-----------	------------------	---------

1599140000	SLDF 5.08 L/F 3 SN OR	PCB plug-in connector, Male connectors, Pitch: 5.08 mm, No. of poles: 3, 180°, Box
1599150000	SLDF 5.08 L/F 4 SN OR	PCB plug-in connector, Male connectors, Pitch: 5.08 mm, No. of poles: 4, 180°, Box
1599160000	SLDF 5.08 L/F 5 SN OR	PCB plug-in connector, Male connectors, Pitch: 5.08 mm, No. of poles: 5, 180°, Box
1599170000	SLDF 5.08 L/F 6 SN OR	PCB plug-in connector, Male connectors, Pitch: 5.08 mm, No. of poles: 6, 180°, Box
1599180000	SLDF 5.08 L/F 7 SN OR	PCB plug-in connector, Male connectors, Pitch: 5.08 mm, No. of poles: 7, 180°, Box
1599190000	SLDF 5.08 L/F 8 SN OR	PCB plug-in connector, Male connectors, Pitch: 5.08 mm, No. of poles: 8, 180°, Box
1599200000	SLDF 5.08 L/F 9 SN OR	PCB plug-in connector, Male connectors, Pitch: 5.08 mm, No. of poles: 9, 180°, Box
1599210000	SLDF 5.08 L/F 10 SN OR	PCB plug-in connector, Male connectors, Pitch: 5.08 mm, No. of poles: 10, 180°, Box
1599220000	SLDF 5.08 L/F 11 SN OR	PCB plug-in connector, Male connectors, Pitch: 5.08 mm, No. of poles: 11, 180°, Box
1599230000	SLDF 5.08 L/F 12 SN OR	PCB plug-in connector, Male connectors, Pitch: 5.08 mm, No. of poles: 12, 180°, Box
1599240000	SLDF 5.08 L/F 13 SN OR	PCB plug-in connector, Male connectors, Pitch: 5.08 mm, No. of poles: 13, 180°, Box
1599250000	SLDF 5.08 L/F 14 SN OR	PCB plug-in connector, Male connectors, Pitch: 5.08 mm, No. of poles: 14, 180°, Box
1599260000	SLDF 5.08 L/F 15 SN OR	PCB plug-in connector, Male connectors, Pitch: 5.08 mm, No. of poles: 15, 180°, Box
1599270000	SLDF 5.08 L/F 16 SN OR	PCB plug-in connector, Male connectors, Pitch: 5.08 mm, No. of poles: 16, 180°, Box