



Chipsmall Limited consists of a professional team with an average of over 10 year of expertise in the distribution of electronic components. Based in Hongkong, we have already established firm and mutual-benefit business relationships with customers from,Europe,America and south Asia,supplying obsolete and hard-to-find components to meet their specific needs.

With the principle of “Quality Parts,Customers Priority,Honest Operation,and Considerate Service”,our business mainly focus on the distribution of electronic components. Line cards we deal with include Microchip,ALPS,ROHM,Xilinx,Pulse,ON,Everlight and Freescale. Main products comprise IC,Modules,Potentiometer,IC Socket,Relay,Connector.Our parts cover such applications as commercial,industrial, and automotives areas.

We are looking forward to setting up business relationship with you and hope to provide you with the best service and solution. Let us make a better world for our industry!



## Contact us

Tel: +86-755-8981 8866 Fax: +86-755-8427 6832

Email & Skype: info@chipsmall.com Web: www.chipsmall.com

Address: A1208, Overseas Decoration Building, #122 Zhenhua RD., Futian, Shenzhen, China



### Top View of Assembly

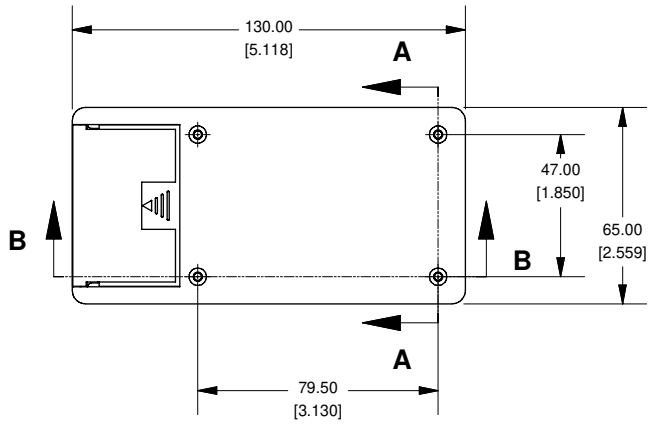

### SECTION A-A End View of Assembly

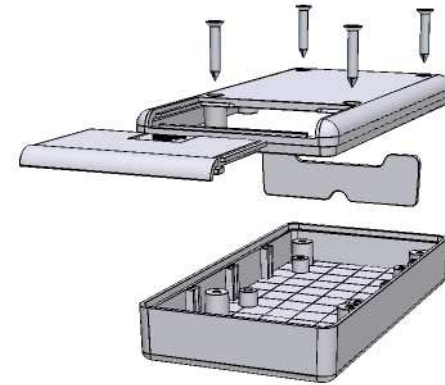
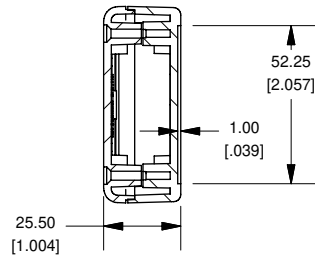

### SECTION B-B Side View of Assembly

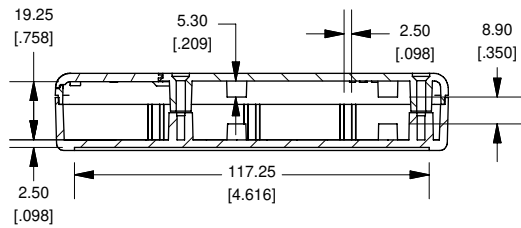

### Top View Looking Inside Box

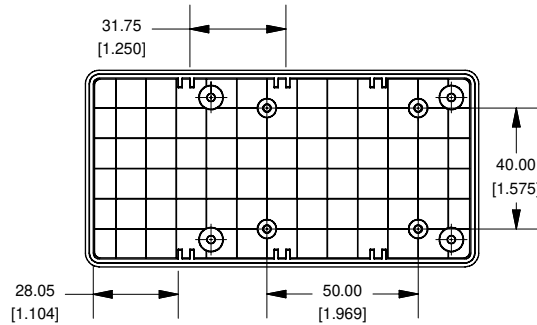

### Lid

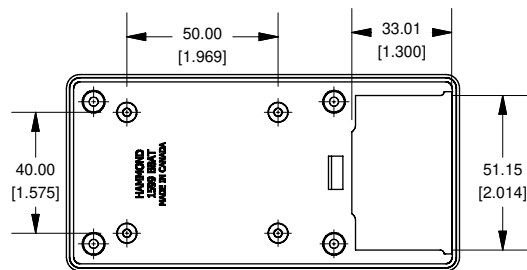

### Divider

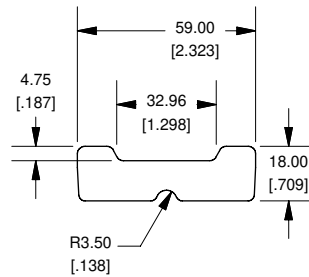

### Maximum P.C. Board Size

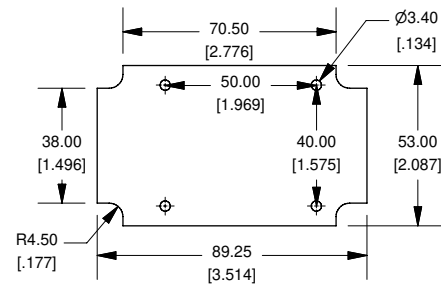

Enclosures can be Factory Modified ( Milling, Drilling, Printing etc. )  
 Contact Factory [mjm@hammondmfg.com](mailto:mjm@hammondmfg.com) for quotes  
 Solid models of this enclosure available in STEP or IGES.

#### NOTE

Purchased assembly includes box, lid and 4 cover screws. Flame retardant ABS carries UL flammability rating of 94 V-0. Various Battery holder kits available.

#### PART NUMBERS

<b>1599B Fire Retardant ABS with Battery Door</b>	
Black FR-ABS	1599BBKBAT
Grey FR-ABS	1599BGYBAT
<b>1599S General Purpose ABS with Battery Door</b>	
Black GP-ABS	1599BSKBAT
Grey GP-ABS	1599BSGYBAT
<b>ACCESSORIES</b>	
Cover Screws for FR-ABS (Pkg 100) [M3 - 0.5 x 20mm Nickel Plated Machine Screws]	1594MS100
Cover Screws for GP-ABS (Pkg 100) [#4 x 3/4" Stainless Steel Self Tapping Screws]	1599BTS100
P.C Board Mounting Screws (Pkg of 50 or 100) [#4 x 1/4" Self Tapping Screws]	1593ATS50 1593ATS100

