



Chipsmall Limited consists of a professional team with an average of over 10 year of expertise in the distribution of electronic components. Based in Hongkong, we have already established firm and mutual-benefit business relationships with customers from,Europe,America and south Asia,supplying obsolete and hard-to-find components to meet their specific needs.

With the principle of “Quality Parts,Customers Priority,Honest Operation,and Considerate Service”,our business mainly focus on the distribution of electronic components. Line cards we deal with include Microchip,ALPS,ROHM,Xilinx,Pulse,ON,Everlight and Freescale. Main products comprise IC,Modules,Potentiometer,IC Socket,Relay,Connector.Our parts cover such applications as commercial,industrial, and automotives areas.

We are looking forward to setting up business relationship with you and hope to provide you with the best service and solution. Let us make a better world for our industry!



Contact us

Tel: +86-755-8981 8866 Fax: +86-755-8427 6832

Email & Skype: info@chipsmall.com Web: www.chipsmall.com

Address: A1208, Overseas Decoration Building, #122 Zhenhua RD., Futian, Shenzhen, China



Top View of Assembly

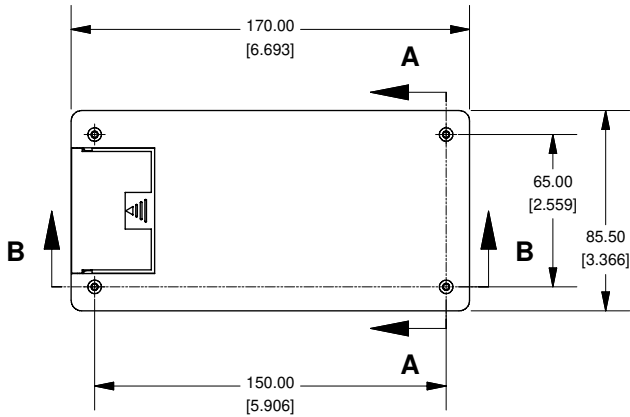

SECTION A-A End View of Assembly

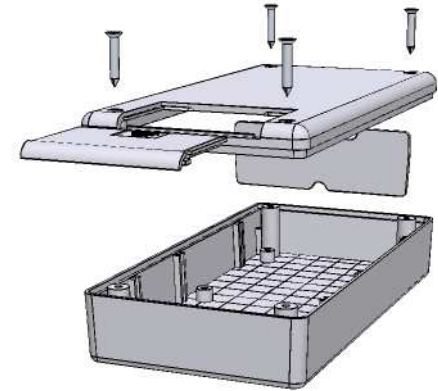
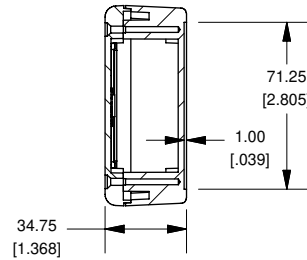

SECTION B-B Side View of Assembly

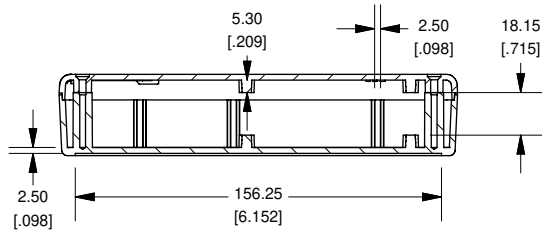

Top View Looking Inside Box

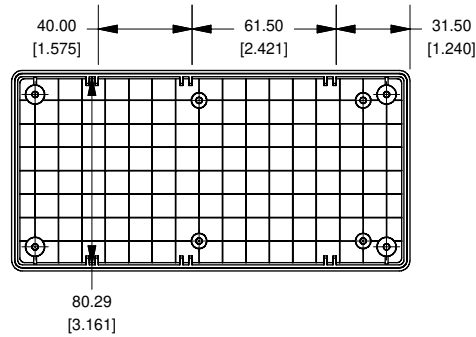

Lid

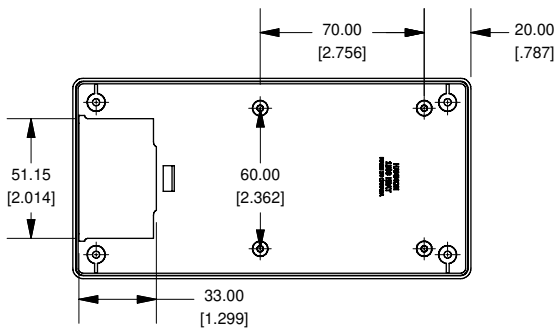

Divider

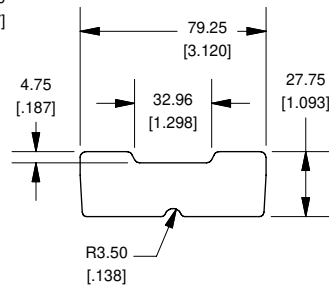

Maximum P.C. Board Size

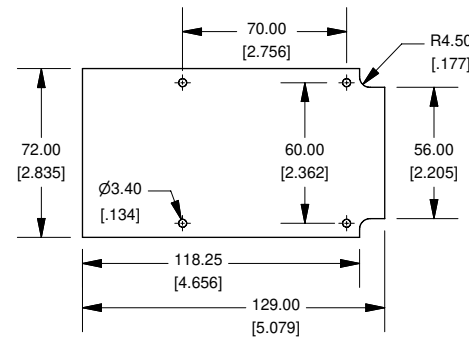

Enclosures can be Factory Modified (Milling, Drilling, Printing etc.)
 Contact Factory mjm@hammondmfg.com for quotes
 Solid models of this enclosure available in STEP or IGES.

NOTE

Purchased assembly includes box, lid and 4 cover screws. Flame retardant ABS carries UL flammability rating of 94 V-0. Various Battery holder kits available.

PART NUMBERS

1599E Fire Retardant ABS	
Black FR-ABS	1599EBKBAT
Grey FR-ABS	1599EGYBAT
1599E High Impact Polystyrene	
Black GP-ABS	1599ESBKBAT
Grey GP-ABS	1599ESGYBAT
ACCESSORIES	
Cover Screws for FR-ABS (Pkg 100) [M3 - 0.5 x 20mm Nickel Plated Machine Screws]	1591MS100
Cover Screws for GP-ABS (Pkg 100) [#4 x 3/4" Stainless Steel Self Tapping Screws]	1598TS100
P.C Board Mounting Screws (Pkg of 50 or 100) [#4 x 1/4" Self Tapping Screws]	1593ATS50 1593ATS100

