



Chipsmall Limited consists of a professional team with an average of over 10 year of expertise in the distribution of electronic components. Based in Hongkong, we have already established firm and mutual-benefit business relationships with customers from,Europe,America and south Asia,supplying obsolete and hard-to-find components to meet their specific needs.

With the principle of “Quality Parts,Customers Priority,Honest Operation,and Considerate Service”,our business mainly focus on the distribution of electronic components. Line cards we deal with include Microchip,ALPS,ROHM,Xilinx,Pulse,ON,Everlight and Freescale. Main products comprise IC,Modules,Potentiometer,IC Socket,Relay,Connector.Our parts cover such applications as commercial,industrial, and automotives areas.

We are looking forward to setting up business relationship with you and hope to provide you with the best service and solution. Let us make a better world for our industry!



## Contact us

Tel: +86-755-8981 8866 Fax: +86-755-8427 6832

Email & Skype: info@chipsmall.com Web: www.chipsmall.com

Address: A1208, Overseas Decoration Building, #122 Zhenhua RD., Futian, Shenzhen, China





# 15GN01MA

## RF Transistor 8V, 50mA, $f_T=1.5\text{GHz}$ , NPN Single MCP

ON Semiconductor®

<http://onsemi.com>

### Features

- Small ON-resistance [ $R_{on}=2\Omega$  ( $I_B=3\text{mA}$ )]
- Small output capacitance [ $C_{ob}=1.1\text{pF}$  ( $V_{CB}=10\text{V}$ )]

### Specifications

#### Absolute Maximum Ratings at $T_a=25^\circ\text{C}$

Parameter	Symbol	Conditions	Ratings	Unit
Collector-to-Base Voltage	$V_{CBO}$		15	V
Collector-to-Emitter Voltage	$V_{CEO}$		8	V
Emitter-to-Base Voltage	$V_{EBO}$		3	V
Collector Current	$I_C$		50	mA
Collector Dissipation	$P_C$	When mounted on ceramic substrate ( $250\text{mm}^2 \times 0.8\text{mm}$ )	400	mW
Junction Temperature	$T_j$		150	$^\circ\text{C}$
Storage Temperature	$T_{stg}$		-55 to +150	$^\circ\text{C}$

Stresses exceeding Maximum Ratings may damage the device. Maximum Ratings are stress ratings only. Functional operation above the Recommended Operating Conditions is not implied. Extended exposure to stresses above the Recommended Operating Conditions may affect device reliability.

### Package Dimensions

unit : mm (typ)

7023A-009

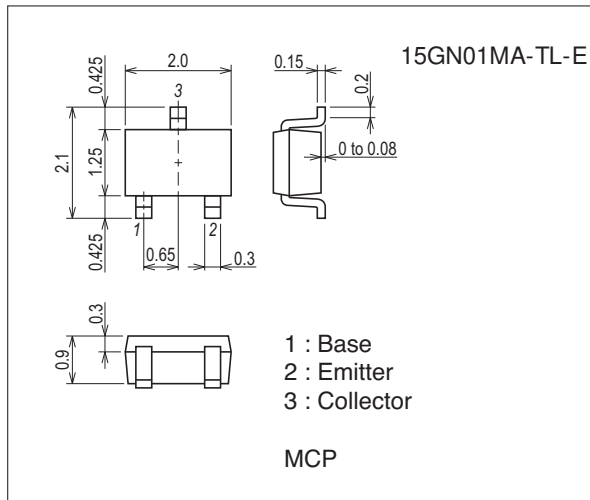

### Product & Package Information

- Package : MCP
- JEITA, JEDEC : SC-70, SOT-323
- Minimum Packing Quantity : 3,000 pcs./reel

### Packing Type: TL

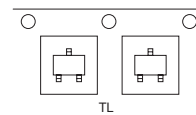

### Marking

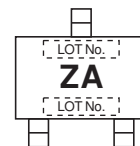

### Electrical Connection

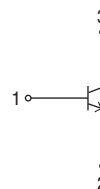

# 15GN01MA

## Electrical Characteristics at Ta=25°C

Parameter	Symbol	Conditions	Ratings			Unit
			min	typ	max	
Collector Cutoff Current	ICBO	V <sub>CB</sub> =10V, I <sub>E</sub> =0A			0.5	μA
Emitter Cutoff Current	IEBO	V <sub>EB</sub> =2V, I <sub>C</sub> =0A			0.5	μA
DC Current Gain	h <sub>FE</sub>	V <sub>CE</sub> =5V, I <sub>C</sub> =10mA	200		400	
Gain-Bandwidth Product	f <sub>T</sub>	V <sub>CE</sub> =5V, I <sub>C</sub> =10mA	1.0	1.5		GHz
Output Capacitance	Cob	V <sub>CB</sub> =10V, f=1MHz		1.1	1.5	pF
Collector-to-Emitter Saturation Voltage	V <sub>CE(sat)</sub>	I <sub>C</sub> =20mA, I <sub>B</sub> =2mA		0.06	0.12	V
Output ON resistance	Ron	I <sub>B</sub> =3mA, f=10kHz		2.0		Ω

## Ordering Information

Device	Package	Shipping	memo
15GN01MA-TL-E	MCP	3,000pcs./reel	Pb Free

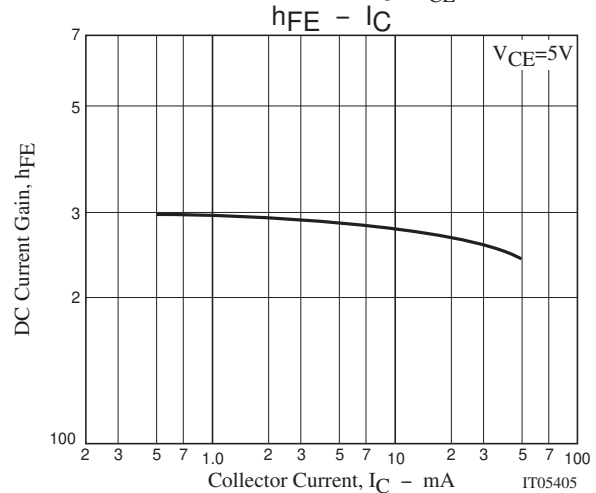
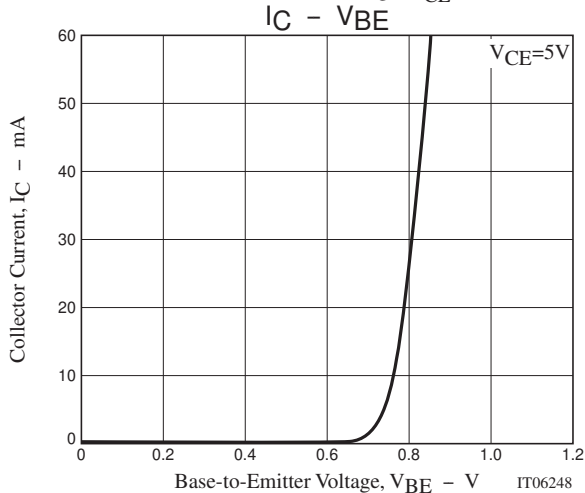
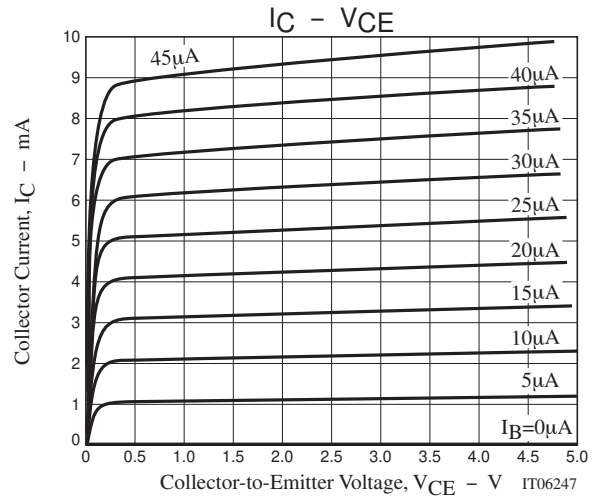
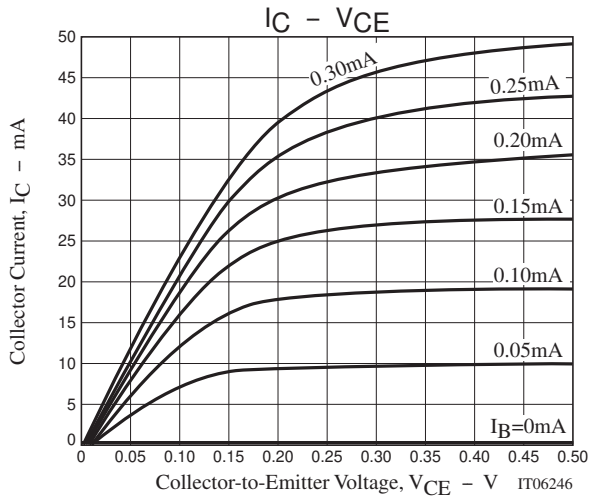

# 15GN01MA

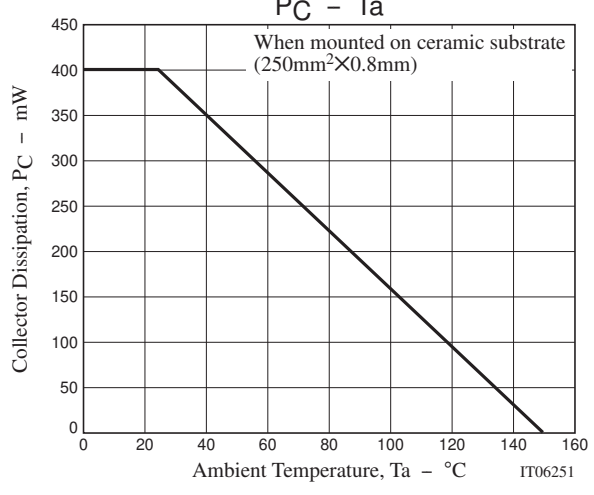
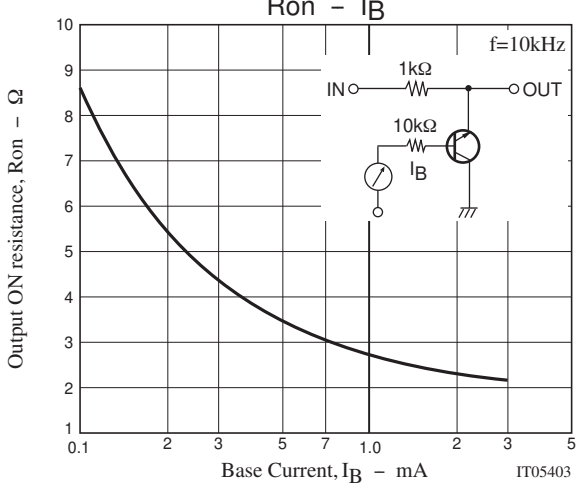
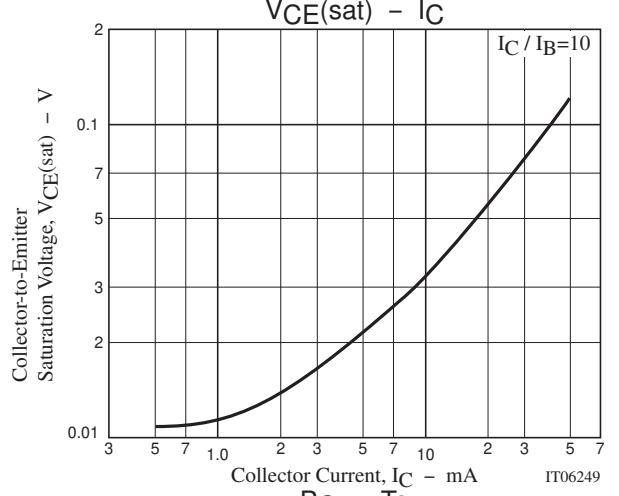
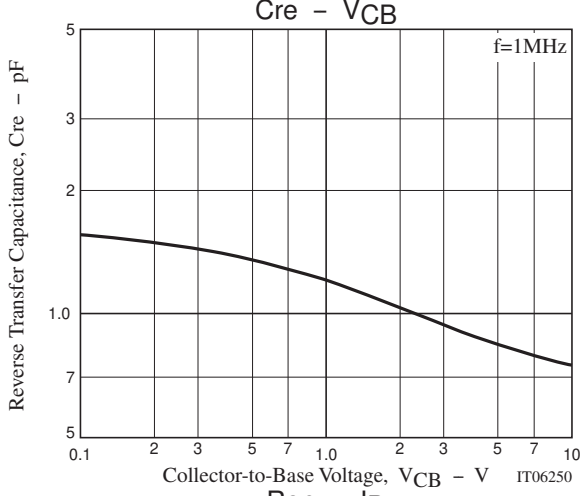
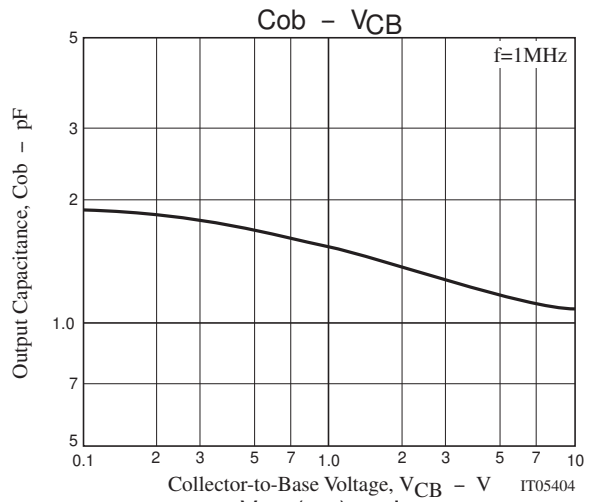
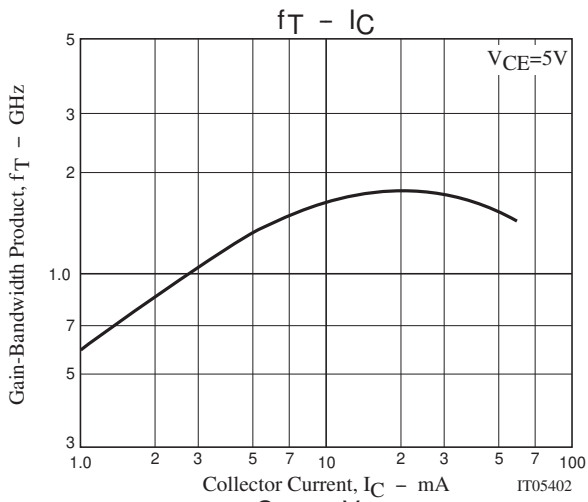

# 15GN01MA

## S Parameters (Common emitter)

$V_{CE}=5V, I_C=5mA, Z_O=50\Omega$

Freq(MHz)	S11	$\angle S11$	S21	$\angle S21$	S12	$\angle S12$	S22	$\angle S22$
100	0.662	-25.65	4.631	122.00	0.028	71.36	0.765	-10.50
200	0.582	-36.72	3.028	112.20	0.051	68.80	0.732	-14.15
300	0.529	-47.21	2.353	104.69	0.071	65.59	0.713	-17.91
400	0.487	-56.61	1.955	97.68	0.088	63.00	0.700	-21.58
500	0.459	-65.82	1.691	91.07	0.103	60.43	0.689	-25.23
600	0.429	-74.14	1.496	85.11	0.116	57.83	0.679	-28.81
700	0.409	-82.44	1.353	79.01	0.128	56.22	0.674	-32.38
800	0.388	-89.94	1.239	73.29	0.138	54.76	0.671	-35.89
900	0.374	-96.79	1.149	67.98	0.148	53.44	0.671	-39.34
1000	0.365	-103.28	1.072	63.13	0.156	52.60	0.670	-42.75

$V_{CE}=5V, I_C=10mA, Z_O=50\Omega$

Freq(MHz)	S11	$\angle S11$	S21	$\angle S21$	S12	$\angle S12$	S22	$\angle S22$
100	0.587	-31.65	6.647	118.78	0.026	71.86	0.694	-11.96
200	0.502	-46.40	4.239	108.57	0.046	68.22	0.653	-15.76
300	0.444	-59.47	3.227	100.32	0.064	65.90	0.630	-19.10
400	0.405	-70.80	2.616	93.18	0.079	63.91	0.619	-22.50
500	0.381	-81.80	2.217	86.64	0.093	62.30	0.607	-25.83
600	0.356	-91.29	1.922	80.82	0.105	60.39	0.598	-29.19
700	0.342	-101.15	1.715	74.86	0.115	59.29	0.596	-32.72
800	0.329	-109.42	1.544	69.40	0.125	58.34	0.593	-36.10
900	0.319	-116.99	1.414	64.16	0.135	57.86	0.594	-39.48
1000	0.315	-124.06	1.305	59.41	0.144	57.47	0.593	-42.80

$V_{CE}=5V, I_C=20mA, Z_O=50\Omega$

Freq(MHz)	S11	$\angle S11$	S21	$\angle S21$	S12	$\angle S12$	S22	$\angle S22$
100	0.505	-41.07	8.945	114.82	0.023	71.42	0.611	-13.64
200	0.417	-60.49	5.500	103.75	0.042	69.03	0.568	-16.14
300	0.369	-76.83	4.039	95.20	0.056	67.39	0.548	-18.89
400	0.341	-90.31	3.197	88.11	0.070	66.22	0.539	-21.75
500	0.328	-102.08	2.654	81.71	0.082	65.43	0.533	-24.77
600	0.316	-112.57	2.264	76.38	0.094	64.49	0.528	-27.99
700	0.311	-122.49	1.988	70.80	0.104	64.03	0.530	-31.32
800	0.306	-130.50	1.771	65.75	0.115	63.95	0.530	-34.57
900	0.304	-137.80	1.605	60.92	0.125	64.09	0.534	-37.93
1000	0.306	-144.30	1.470	56.51	0.135	64.16	0.537	-41.24

# 15GN01MA

## Embossed Taping Specification

15GN01MA-TL-E

### 1. Packing Format

Package Name	Carrier Tape Type	Maximum Number of devices contained (pcs)			Packing format	
		Reel	Inner box	Outer box	Inner BOX (C-1)	Outer BOX (A-7)
MCP	MCP	3,000	15,000	90,000	5 reels contained Dimensions:mm (external) 183×72×185	6 inner boxes contained Dimensions:mm (external) 440×195×210

#### Packing method

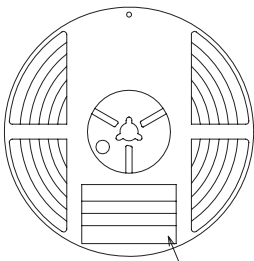

Reel label

Type No.  
LOT No.  
Quantity  
Origin

Reel label, Inner box label  
(unit: mm)

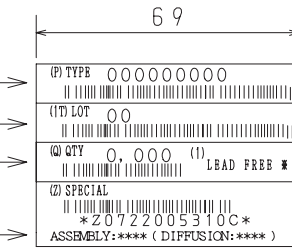

Outer box label

It is a label at the time of factory shipments.  
The form of a label may change in physical distribution process.

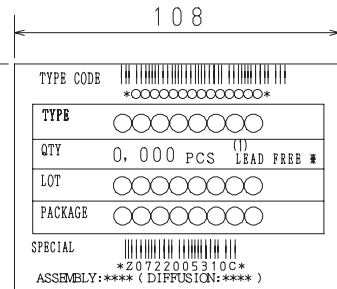

NOTE (1)

The LEAD FREE \* description shows that the surface treatment of the terminal is lead free.

Label	JEITA Phase
LEAD FREE 3	JEITA Phase 3A
LEAD FREE 4	JEITA Phase 3

### 2. Taping configuration

#### 2-1. Carrier tape size (unit:mm)

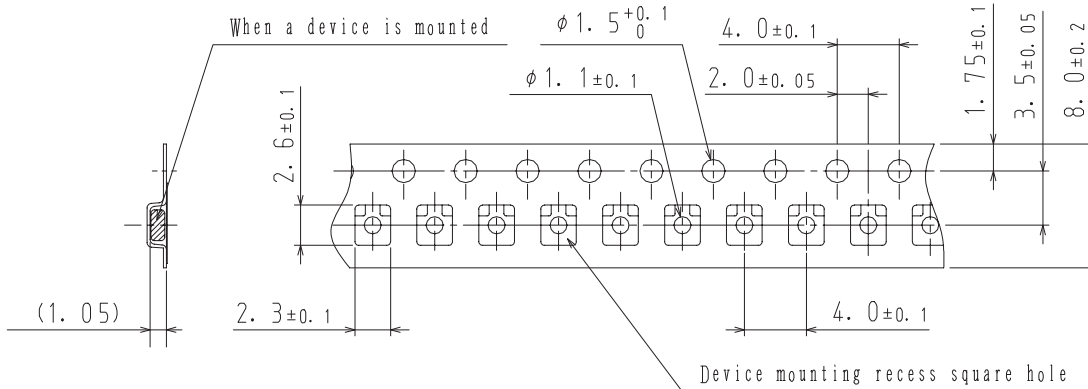

#### 2-2. Device placement direction

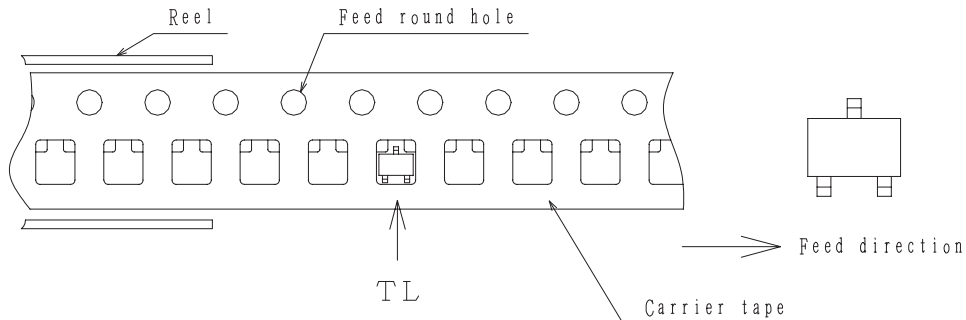

Those with oen electrode terminal on the feed hole side.....TL

# 15GN01MA

## Outline Drawing

15GN01MA-TL-E

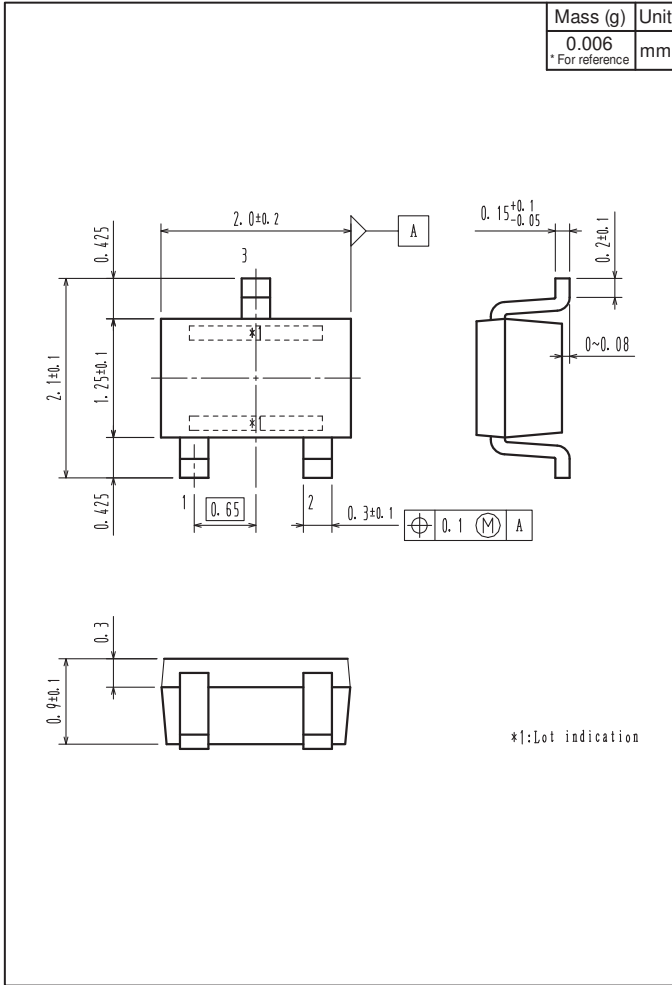

## Land Pattern Example

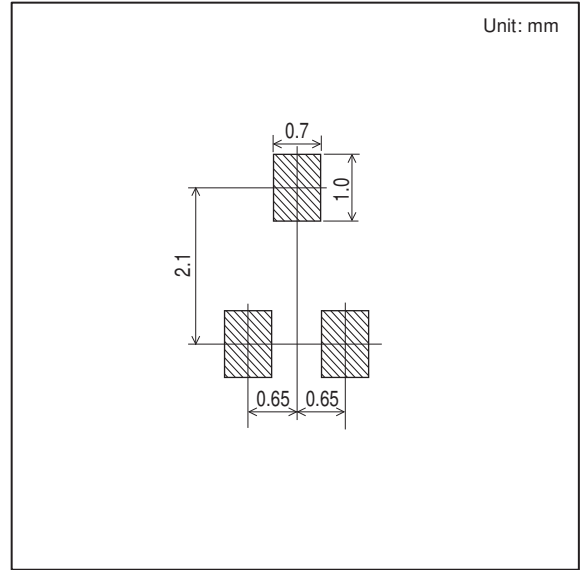

ON Semiconductor and the ON logo are registered trademarks of Semiconductor Components Industries, LLC (SCILLC). SCILLC owns the rights to a number of patents, trademarks, copyrights, trade secrets, and other intellectual property. A listing of SCILLC's product/patent coverage may be accessed at [www.onsemi.com/site/pdf/Patent-Marking.pdf](http://www.onsemi.com/site/pdf/Patent-Marking.pdf). SCILLC reserves the right to make changes without further notice to any products herein. SCILLC makes no warranty, representation or guarantee regarding the suitability of its products for any particular purpose, nor does SCILLC assume any liability arising out of the application or use of any product or circuit, and specifically disclaims any and all liability, including without limitation special, consequential or incidental damages. "Typical" parameters which may be provided in SCILLC data sheets and/or specifications can and do vary in different applications and actual performance may vary over time. All operating parameters, including "Typicals" must be validated for each customer application by customer's technical experts. SCILLC does not convey any license under its patent rights nor the rights of others. SCILLC products are not designed, intended, or authorized for use as components in systems intended for surgical implant into the body, or other applications intended to support or sustain life, or for any other application in which the failure of the SCILLC product could create a situation where personal injury or death may occur. Should Buyer purchase or use SCILLC products for any such unintended or unauthorized application, Buyer shall indemnify and hold SCILLC and its officers, employees, subsidiaries, affiliates, and distributors harmless against all claims, costs, damages, and expenses, and reasonable attorney fees arising out of, directly or indirectly, any claim of personal injury or death associated with such unintended or unauthorized use, even if such claim alleges that SCILLC was negligent regarding the design or manufacture of the part. SCILLC is an Equal Opportunity/Affirmative Action Employer. This literature is subject to all applicable copyright laws and is not for resale in any manner.