



Chipsmall Limited consists of a professional team with an average of over 10 year of expertise in the distribution of electronic components. Based in Hongkong, we have already established firm and mutual-benefit business relationships with customers from,Europe,America and south Asia,supplying obsolete and hard-to-find components to meet their specific needs.

With the principle of “Quality Parts,Customers Priority,Honest Operation,and Considerate Service”,our business mainly focus on the distribution of electronic components. Line cards we deal with include Microchip,ALPS,ROHM,Xilinx,Pulse,ON,Everlight and Freescale. Main products comprise IC,Modules,Potentiometer,IC Socket,Relay,Connector.Our parts cover such applications as commercial,industrial, and automotives areas.

We are looking forward to setting up business relationship with you and hope to provide you with the best service and solution. Let us make a better world for our industry!



Contact us

Tel: +86-755-8981 8866 Fax: +86-755-8427 6832

Email & Skype: info@chipsmall.com Web: www.chipsmall.com

Address: A1208, Overseas Decoration Building, #122 Zhenhua RD., Futian, Shenzhen, China





15GN03MA

RF Transistor

10V, 70mA, $f_T=1.5\text{GHz}$, NPN Single MCP

ON Semiconductor®

<http://onsemi.com>

Applications

- VHF, RF, MIXER, OSC, IF amplifier

Features

- High cut-off frequency : $f_T=1.5\text{GHz}$ typ
- High gain : $|S_{21e}|^2=13\text{dB}$ typ ($f=0.4\text{GHz}$)
- Ultrasmall package permitting applied sets to be small and slim

Specifications

Absolute Maximum Ratings at $T_a=25^\circ\text{C}$

Parameter	Symbol	Conditions	Ratings	Unit
Collector-to-Base Voltage	V_{CBO}		20	V
Collector-to-Emitter Voltage	V_{CEO}		10	V
Emitter-to-Base Voltage	V_{EBO}		3	V
Collector Current	I_C		70	mA
Collector Dissipation	P_C	When mounted on ceramic substrate (250mm ² ×0.8mm)	400	mW
Junction Temperature	T_j		150	$^\circ\text{C}$
Storage Temperature	T_{stg}		-55 to +150	$^\circ\text{C}$

Stresses exceeding Maximum Ratings may damage the device. Maximum Ratings are stress ratings only. Functional operation above the Recommended Operating Conditions is not implied. Extended exposure to stresses above the Recommended Operating Conditions may affect device reliability.

Package Dimensions

unit : mm (typ)

7023A-009

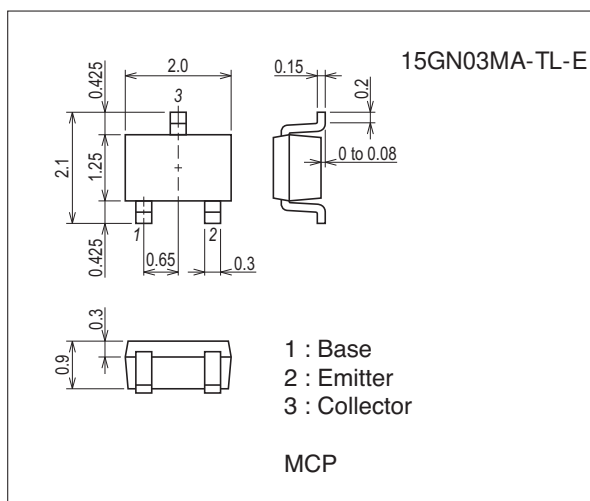

Product & Package Information

- Package : MCP
- JEITA, JEDEC : SC-70, SOT-323
- Minimum Packing Quantity : 3,000 pcs./reel

Packing Type: TL

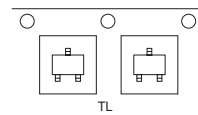

Marking

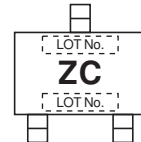

Electrical Connection

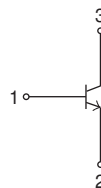

15GN03MA

Electrical Characteristics at Ta=25°C

Parameter	Symbol	Conditions	Ratings			Unit
			min	typ	max	
Collector Cutoff Current	ICBO	V _{CB} =10V, I _E =0A			0.1	μA
Emitter Cutoff Current	IEBO	V _{EB} =2V, I _C =0A			1	μA
DC Current Gain	h _{FE}	V _{CE} =5V, I _C =10mA	100		180	
Gain-Bandwidth Product	f _T	V _{CE} =5V, I _C =20mA	1.0	1.5		GHz
Output Capacitance	C _{ob}	V _{CB} =10V, f=1MHz		0.95	1.25	pF
Reverse Transfer Capacitance	C _{re}				0.65	pF
Forward Transfer Gain	S _{21e} ²	V _{CE} =5V, I _C =20mA, f=0.4GHz	10	13		dB
Noise Figure	NF	V _{CE} =3V, I _C =2mA, f=0.4GHz		1.6		dB

Ordering Information

Device	Package	Shipping	memo
15GN03MA-TL-E	MCP	3,000pcs./reel	Pb Free

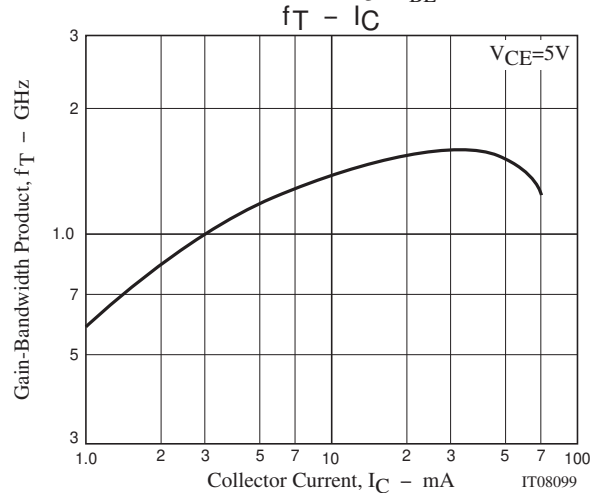
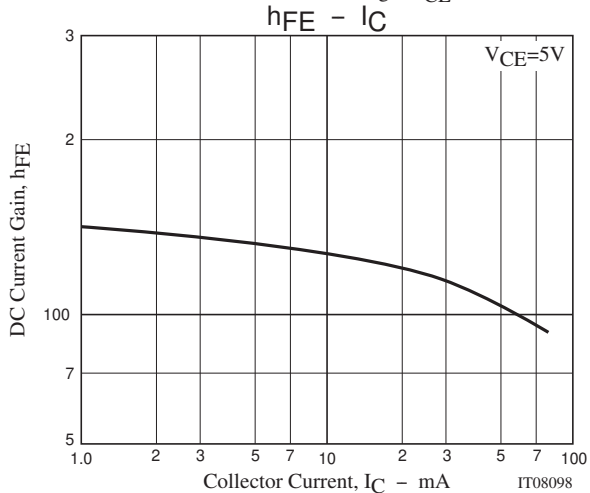
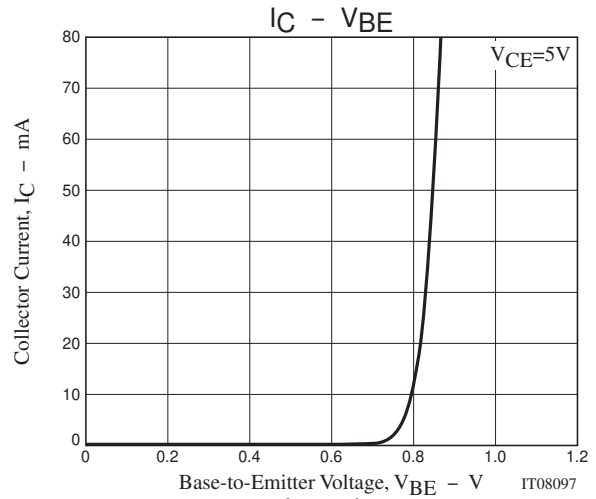
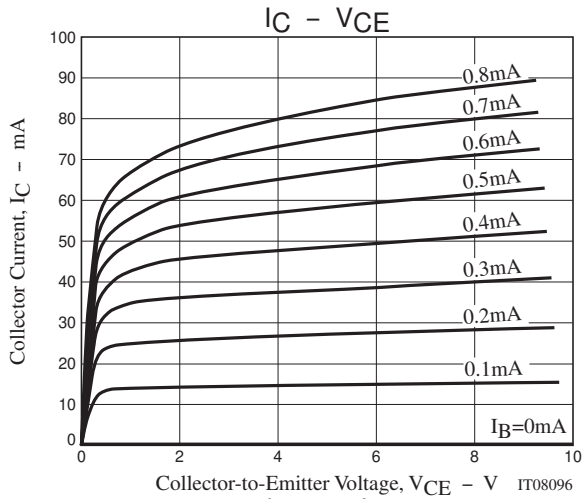

15GN03MA

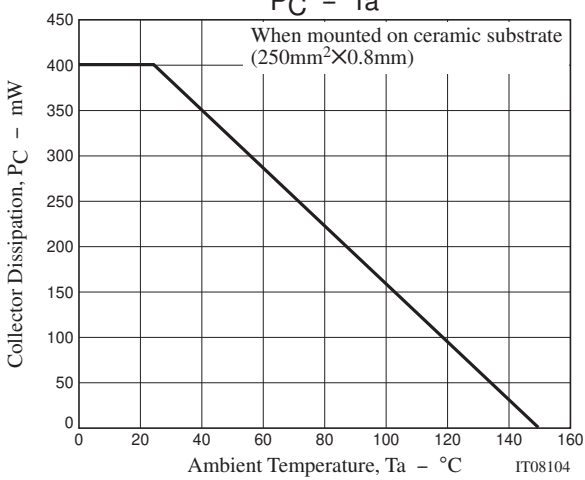
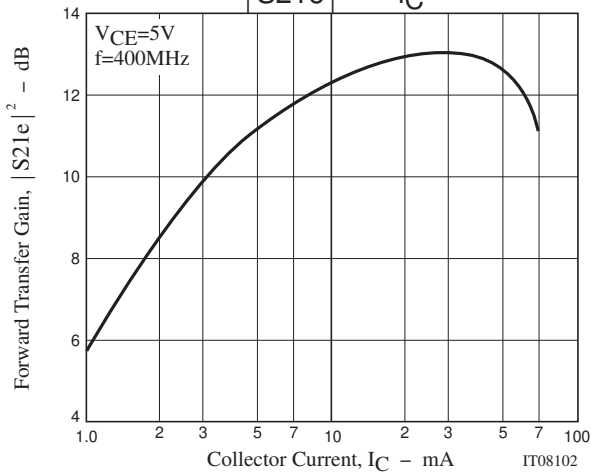
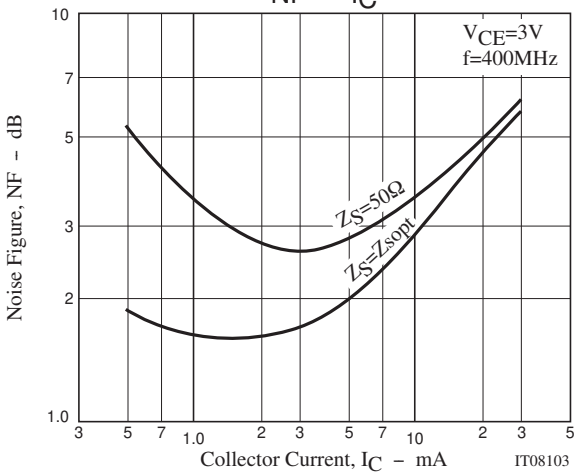
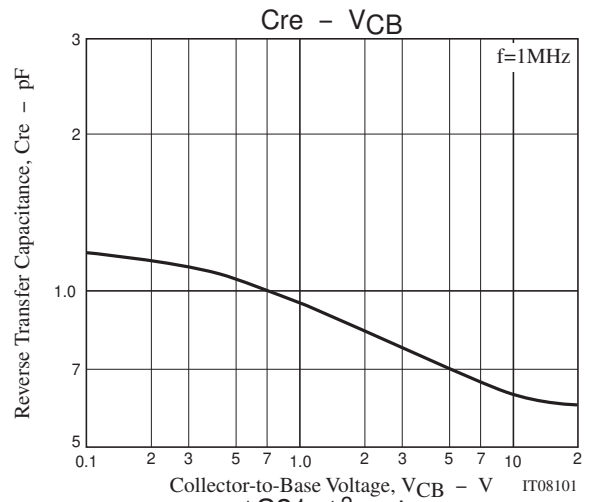
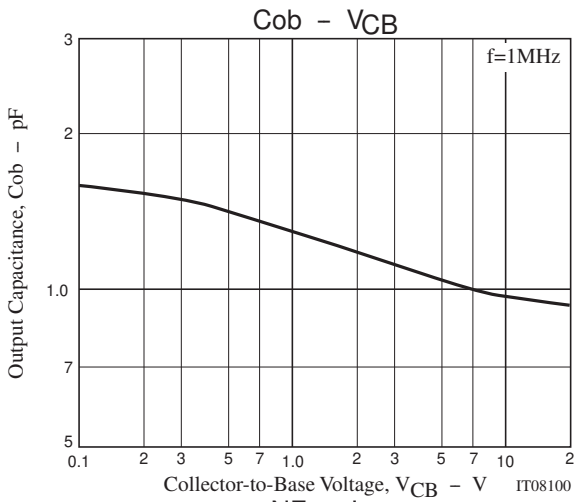

15GN03MA

S Parameters (Common emitter)

$V_{CE}=5V, I_C=1mA, Z_O=50\Omega$

Freq(MHz)	S11	$\angle S11$	S21	$\angle S21$	S12	$\angle S12$	S22	$\angle S22$
100	0.927	-39.48	3.051	153.95	0.045	66.57	0.938	-5.28
200	0.877	-72.13	2.643	134.85	0.072	53.42	0.879	-10.12
300	0.831	-97.09	2.258	118.70	0.090	41.89	0.834	-15.17
400	0.796	-115.43	1.925	105.65	0.093	33.66	0.806	-20.70
500	0.772	-128.51	1.645	95.12	0.090	29.42	0.796	-25.57
600	0.759	-139.76	1.420	86.92	0.085	28.20	0.796	-28.96
700	0.754	-148.33	1.255	80.31	0.080	30.19	0.792	-31.48
800	0.750	-155.54	1.132	74.68	0.072	36.45	0.790	-34.42
900	0.746	-162.07	1.033	69.44	0.067	44.81	0.793	-37.89
1000	0.743	-167.59	0.948	65.05	0.065	55.74	0.796	-41.83

$V_{CE}=5V, I_C=3mA, Z_O=50\Omega$

Freq(MHz)	S11	$\angle S11$	S21	$\angle S21$	S12	$\angle S12$	S22	$\angle S22$
100	0.819	-66.73	7.544	137.99	0.036	55.23	0.862	-14.15
200	0.733	-107.53	5.274	115.44	0.050	43.07	0.730	-17.07
300	0.698	-130.44	3.901	102.51	0.055	40.37	0.691	-20.60
400	0.682	-144.75	3.111	93.53	0.056	41.56	0.673	-22.18
500	0.674	-154.20	2.563	85.87	0.056	46.54	0.680	-25.14
600	0.669	-161.91	2.175	79.64	0.057	53.71	0.686	-28.23
700	0.669	-167.44	1.884	74.61	0.061	62.91	0.686	-30.58
800	0.671	-172.33	1.680	70.09	0.067	70.67	0.690	-33.35
900	0.672	-176.77	1.520	65.76	0.075	78.25	0.695	-36.65
1000	0.672	-179.40	1.386	61.98	0.086	83.86	0.700	-40.53

$V_{CE}=5V, I_C=5mA, Z_O=50\Omega$

Freq(MHz)	S11	$\angle S11$	S21	$\angle S21$	S12	$\angle S12$	S22	$\angle S22$
100	0.745	-85.56	10.487	129.32	0.031	52.32	0.808	-17.13
200	0.673	-125.68	6.596	107.46	0.041	43.79	0.695	-19.72
300	0.650	-144.45	4.641	95.99	0.044	45.46	0.655	-20.94
400	0.643	-155.93	3.583	88.14	0.046	51.02	0.641	-22.34
500	0.641	-163.08	2.926	81.98	0.051	57.47	0.638	-24.48
600	0.641	-169.17	2.468	76.86	0.055	65.57	0.640	-27.05
700	0.642	-173.85	2.139	72.14	0.064	72.10	0.640	-29.96
800	0.645	-177.59	1.898	68.01	0.072	78.01	0.643	-32.86
900	0.648	-179.02	1.708	64.03	0.082	84.74	0.654	-36.05
1000	0.649	-175.69	1.565	60.67	0.096	88.35	0.663	-39.64

$V_{CE}=5V, I_C=10mA, Z_O=50\Omega$

Freq(MHz)	S11	$\angle S11$	S21	$\angle S21$	S12	$\angle S12$	S22	$\angle S22$
100	0.648	-111.11	13.755	118.07	0.025	49.17	0.710	-18.60
200	0.617	-144.00	7.787	99.84	0.031	50.50	0.618	-18.94
300	0.610	-157.84	5.322	90.62	0.035	55.71	0.593	-19.18
400	0.611	-165.84	4.071	84.05	0.042	63.53	0.585	-20.81
500	0.612	-171.10	3.295	78.75	0.049	72.26	0.585	-23.14
600	0.616	-175.51	2.770	74.15	0.059	76.93	0.591	-25.68
700	0.620	-179.00	2.401	69.78	0.068	81.33	0.595	-28.62
800	0.622	-178.16	2.122	65.84	0.080	85.49	0.598	-31.66
900	0.629	-175.42	1.906	62.06	0.091	88.11	0.610	-34.80
1000	0.632	-172.79	1.741	58.71	0.104	90.16	0.619	-38.30

15GN03MA

S Parameters (Common emitter)

$V_{CE}=5V, I_C=15mA, Z_O=50\Omega$

Freq(MHz)	S11	$\angle S11$	S21	$\angle S21$	S12	$\angle S12$	S22	$\angle S22$
100	0.608	-124.26	15.141	112.79	0.021	49.66	0.661	-18.68
200	0.596	-152.05	8.271	96.59	0.028	56.25	0.584	-17.69
300	0.594	-163.33	5.613	88.34	0.034	63.87	0.566	-18.43
400	0.600	-169.82	4.267	82.26	0.042	71.61	0.561	-19.87
500	0.601	-173.91	3.457	77.23	0.052	77.39	0.564	-22.13
600	0.606	-177.77	2.902	72.65	0.061	81.90	0.570	-24.90
700	0.613	179.41	2.501	68.50	0.071	84.02	0.573	-27.96
800	0.617	176.72	2.210	64.59	0.083	86.75	0.579	-30.98
900	0.624	174.31	1.988	60.86	0.094	88.46	0.592	-34.26
1000	0.628	171.96	1.808	57.39	0.108	90.57	0.599	-37.51

$V_{CE}=5V, I_C=20mA, Z_O=50\Omega$

Freq(MHz)	S11	$\angle S11$	S21	$\angle S21$	S12	$\angle S12$	S22	$\angle S22$
100	0.587	-132.33	15.887	109.73	0.018	50.98	0.630	-18.23
200	0.589	-156.83	8.517	94.77	0.026	60.57	0.563	-17.10
300	0.590	-166.31	5.751	86.97	0.034	66.88	0.549	-17.73
400	0.593	-171.88	4.373	80.95	0.043	73.76	0.547	-19.30
500	0.598	-175.61	3.529	76.08	0.052	79.21	0.552	-21.55
600	0.604	-178.89	2.958	71.70	0.063	82.86	0.558	-24.41
700	0.611	178.36	2.550	67.43	0.073	85.71	0.560	-27.19
800	0.616	176.07	2.257	63.56	0.085	87.76	0.569	-30.31
900	0.624	173.75	2.026	59.99	0.097	89.02	0.581	-33.63
1000	0.628	171.39	1.838	56.47	0.109	90.88	0.590	-36.92

$V_{CE}=5V, I_C=30mA, Z_O=50\Omega$

Freq(MHz)	S11	$\angle S11$	S21	$\angle S21$	S12	$\angle S12$	S22	$\angle S22$
100	0.574	-141.90	16.518	106.28	0.017	56.75	0.594	-17.60
200	0.584	-161.69	8.702	92.68	0.024	65.21	0.541	-16.13
300	0.587	-169.42	5.851	85.19	0.033	71.56	0.531	-16.69
400	0.596	-174.12	4.433	79.42	0.042	77.01	0.532	-18.41
500	0.599	-177.29	3.570	74.54	0.053	82.34	0.536	-20.78
600	0.609	179.93	2.987	70.07	0.063	84.47	0.545	-23.60
700	0.616	177.48	2.574	65.88	0.073	86.83	0.550	-26.54
800	0.621	175.27	2.268	61.99	0.085	88.18	0.559	-29.78
900	0.631	173.12	2.033	58.20	0.096	90.72	0.571	-33.08
1000	0.638	170.96	1.845	54.81	0.111	91.80	0.582	-36.46

$V_{CE}=5V, I_C=50mA, Z_O=50\Omega$

Freq(MHz)	S11	$\angle S11$	S21	$\angle S21$	S12	$\angle S12$	S22	$\angle S22$
100	0.578	-151.54	16.222	102.78	0.015	58.15	0.564	-16.24
200	0.596	-166.79	8.428	90.13	0.023	71.59	0.524	-14.78
300	0.603	-172.63	5.641	82.89	0.033	76.27	0.520	-15.94
400	0.611	-176.28	4.254	77.21	0.043	79.95	0.521	-17.71
500	0.618	-178.98	3.421	72.11	0.052	83.78	0.530	-20.31
600	0.629	178.44	2.851	67.60	0.064	86.83	0.538	-23.39
700	0.639	176.23	2.452	63.15	0.074	88.24	0.546	-26.40
800	0.647	174.01	2.155	59.33	0.087	89.54	0.555	-29.74
900	0.657	171.87	1.921	55.44	0.099	92.59	0.568	-33.37
1000	0.664	169.65	1.740	51.95	0.113	94.10	0.581	-36.94

15GN03MA

Embossed Taping Specification

15GN03MA-TL-E

1. Packing Format

Package Name	Carrier Tape Type	Maximum Number of devices contained (pcs)			Packing format	
		Reel	Inner box	Outer box	Inner BOX (C-1)	Outer BOX (A-7)
MCP	MCP	3,000	15,000	90,000	5 reels contained Dimensions:mm (external) 183×72×185	6 inner boxes contained Dimensions:mm (external) 440×195×210

Packing method

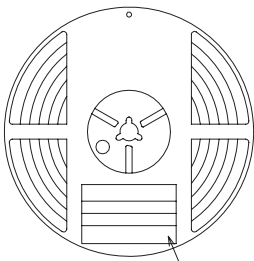

Reel label

Type No.
LOT No.
Quantity
Origin

Reel label, Inner box label
(unit:mm)

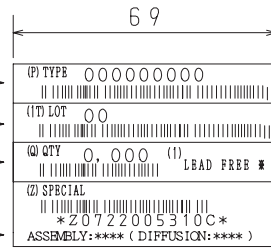

Outer box label

It is a label at the time of factory shipments.
The form of a label may change in physical distribution process.

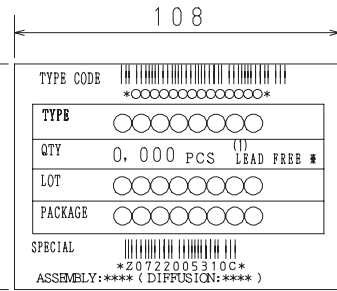

NOTE (1)

The LEAD FREE * description shows that the surface treatment of the terminal is lead free.

Label	JEITA Phase
LEAD FREE 3	JEITA Phase 3A
LEAD FREE 4	JEITA Phase 3

2. Taping configuration

2-1. Carrier tape size (unit:mm)

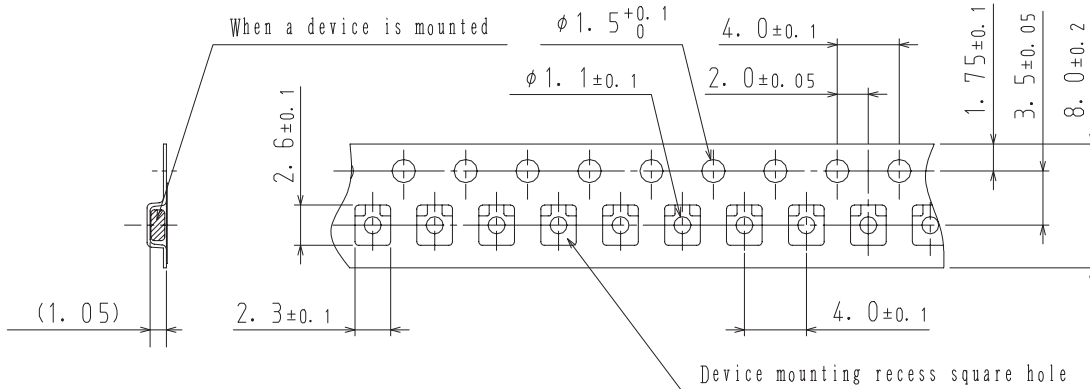

2-2. Device placement direction

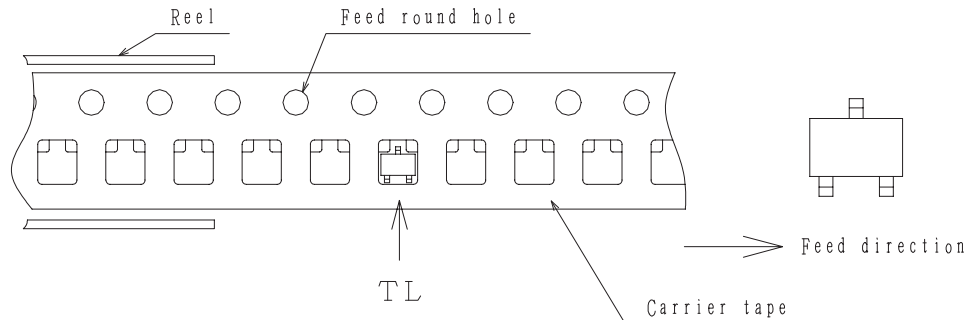

Those with one electrode terminal on the feed hole side.....TL

15GN03MA

Outline Drawing

15GN03MA-TL-E

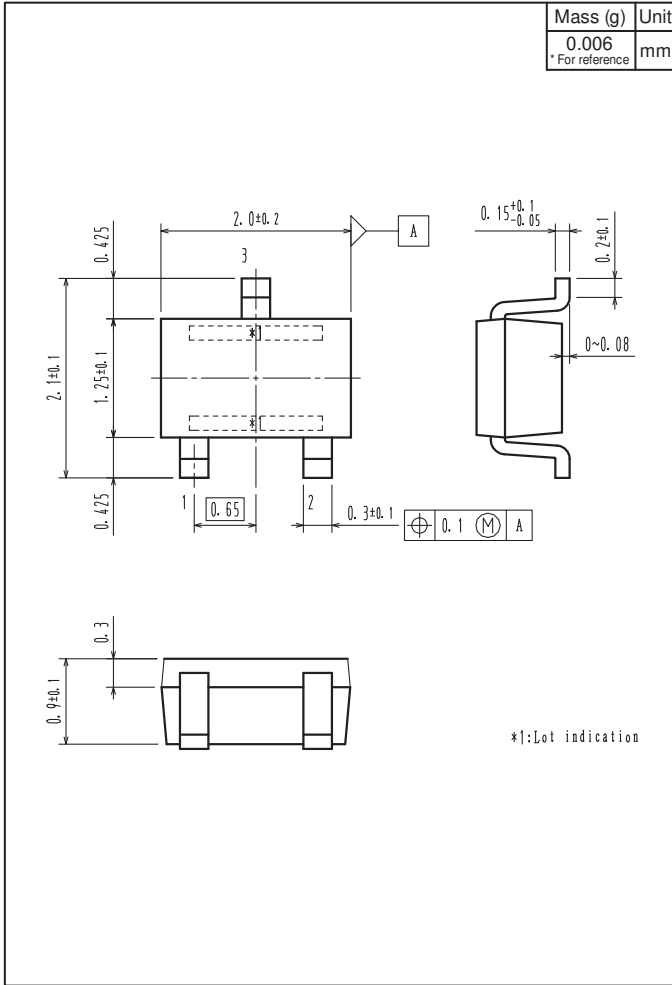

Land Pattern Example

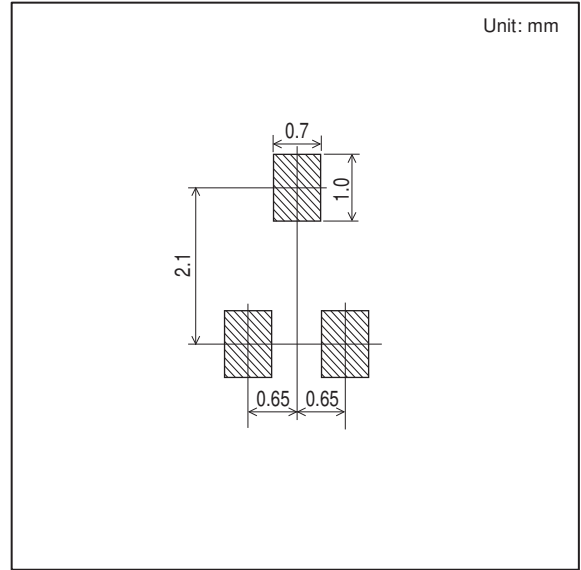

ON Semiconductor and the ON logo are registered trademarks of Semiconductor Components Industries, LLC (SCILLC). SCILLC owns the rights to a number of patents, trademarks, copyrights, trade secrets, and other intellectual property. A listing of SCILLC's product/patent coverage may be accessed at www.onsemi.com/site/pdf/Patent-Marking.pdf. SCILLC reserves the right to make changes without further notice to any products herein. SCILLC makes no warranty, representation or guarantee regarding the suitability of its products for any particular purpose, nor does SCILLC assume any liability arising out of the application or use of any product or circuit, and specifically disclaims any and all liability, including without limitation special, consequential or incidental damages. "Typical" parameters which may be provided in SCILLC data sheets and/or specifications can and do vary in different applications and actual performance may vary over time. All operating parameters, including "Typicals" must be validated for each customer application by customer's technical experts. SCILLC does not convey any license under its patent rights nor the rights of others. SCILLC products are not designed, intended, or authorized for use as components in systems intended for surgical implant into the body, or other applications intended to support or sustain life, or for any other application in which the failure of the SCILLC product could create a situation where personal injury or death may occur. Should Buyer purchase or use SCILLC products for any such unintended or unauthorized application, Buyer shall indemnify and hold SCILLC and its officers, employees, subsidiaries, affiliates, and distributors harmless against all claims, costs, damages, and expenses, and reasonable attorney fees arising out of, directly or indirectly, any claim of personal injury or death associated with such unintended or unauthorized use, even if such claim alleges that SCILLC was negligent regarding the design or manufacture of the part. SCILLC is an Equal Opportunity/Affirmative Action Employer. This literature is subject to all applicable copyright laws and is not for resale in any manner.