



Chipsmall Limited consists of a professional team with an average of over 10 year of expertise in the distribution of electronic components. Based in Hongkong, we have already established firm and mutual-benefit business relationships with customers from,Europe,America and south Asia,supplying obsolete and hard-to-find components to meet their specific needs.

With the principle of “Quality Parts,Customers Priority,Honest Operation,and Considerate Service”,our business mainly focus on the distribution of electronic components. Line cards we deal with include Microchip,ALPS,ROHM,Xilinx,Pulse,ON,Everlight and Freescale. Main products comprise IC,Modules,Potentiometer,IC Socket,Relay,Connector.Our parts cover such applications as commercial,industrial, and automotives areas.

We are looking forward to setting up business relationship with you and hope to provide you with the best service and solution. Let us make a better world for our industry!



Contact us

Tel: +86-755-8981 8866 Fax: +86-755-8427 6832

Email & Skype: info@chipsmall.com Web: www.chipsmall.com

Address: A1208, Overseas Decoration Building, #122 Zhenhua RD., Futian, Shenzhen, China



| LOC | DIST | REV | DATE | BY | APPV |
|-----|------|-----|------|----|------|
| ES | 00 | | | | |

| REVISIONS | | | | | |
|-----------|-----------|----|------|-------------------------|--|
| REV | DATE | BY | APPV | DESCRIPTION | |
| H1 | 03AUG2012 | CZ | SZ | REVISED 1-2 | |
| H3 | 30NOV2014 | CZ | SZ | ADD NEW DASH NUMBER 1-3 | |
| H4 | 02AUG2016 | CZ | SZ | ADD NEW DASH NUMBER 1-4 | |
| H5 | 17JAN2017 | WY | SZ | REV PER ECR-17-000673 | |

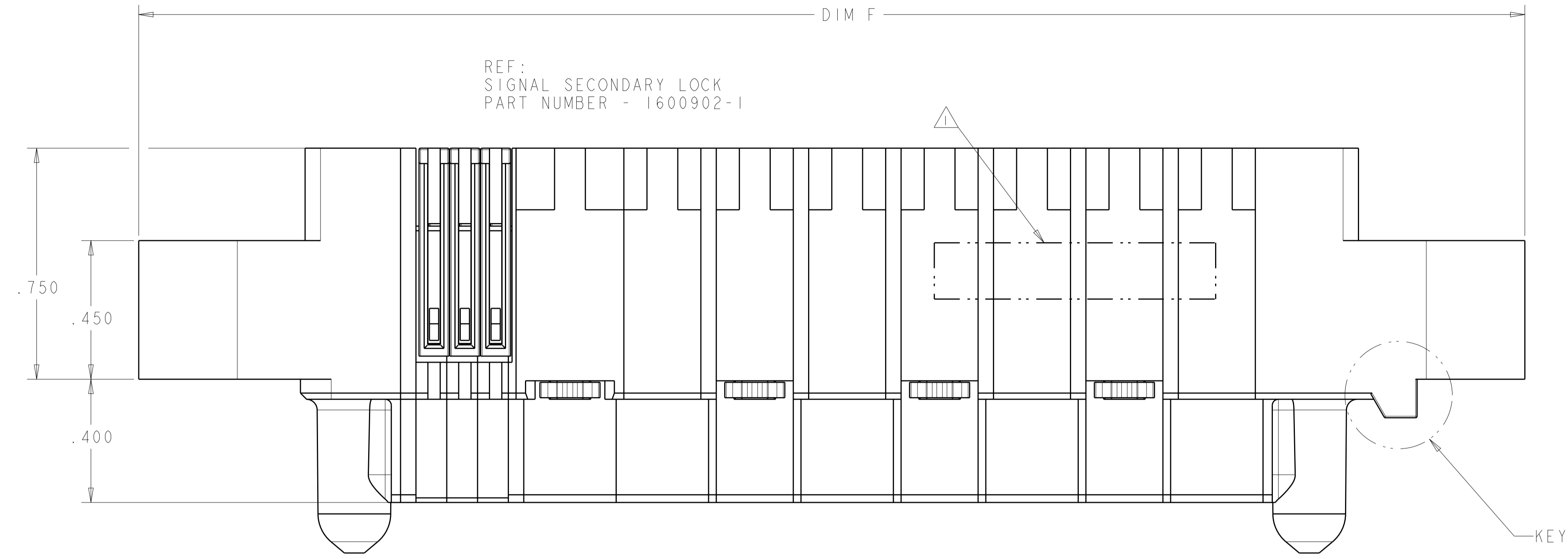

- 1 COMPANY TRADEMARK, PART NUMBER, AND DATE CODE TO BE MARKED IN AREA SHOWN. PARTS UNDER 2.00 LONG MAY BE MARKED ON BOTH SIDES.
- 2 MATERIAL: THERMO PLASTIC, UL94 V-0.
- 3 DATUM LOCATIONS AND BASIC DIMENSIONS TO BE ESTABLISHED BY THE CUSTOMER.
- 4 BULKHEAD THICKNESS RANGE: .031 - .100.
- 5 CONNECTOR MATED TO PANEL FROM OPPOSITE SIDE.
- 6 NO BURRS ALLOWED ON OPPOSITE (MATING) SIDE.
- 7 CONNECTOR KEEP OUT ZONE.
- 8 MOUNT CONNECTOR WITH TYCO HARDWARE KIT 1600914-1 FOR .050 (1.27mm) MIN RADIAL FLOAT.
- 9 VARIABLE DIMENSION SHOW ON VIEW (SHEET 2).
- 10 FOR THE CONFIGURATION OF 1-1600616-5, 1-1600616-6, PLEASE REFER TO THE SHEET 4.

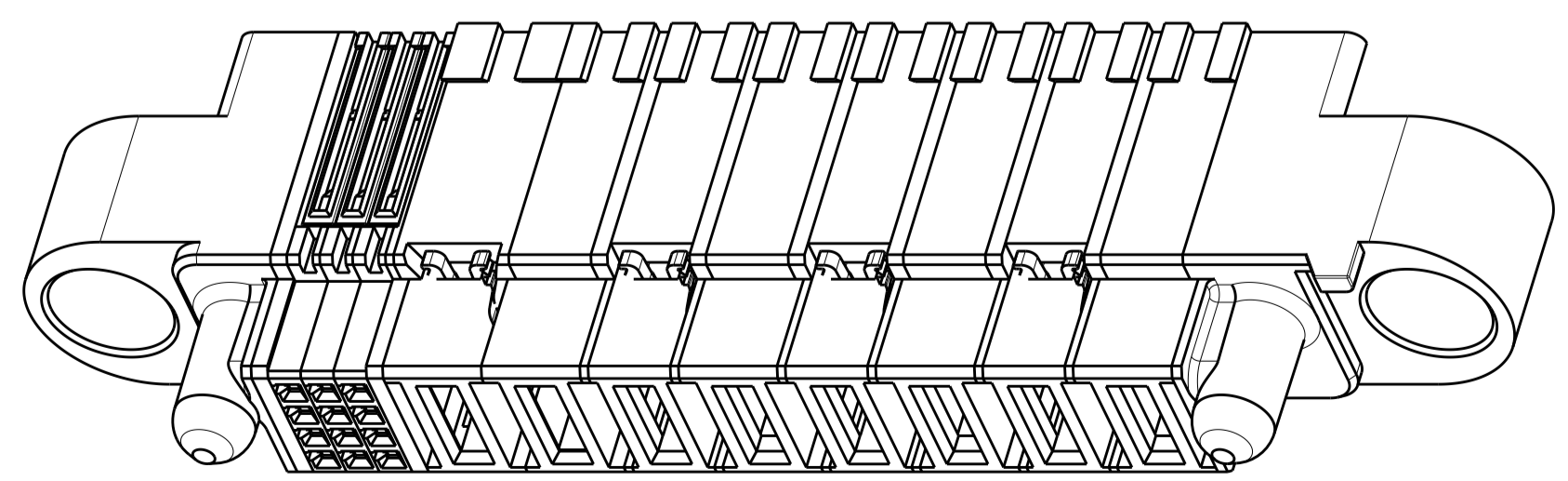
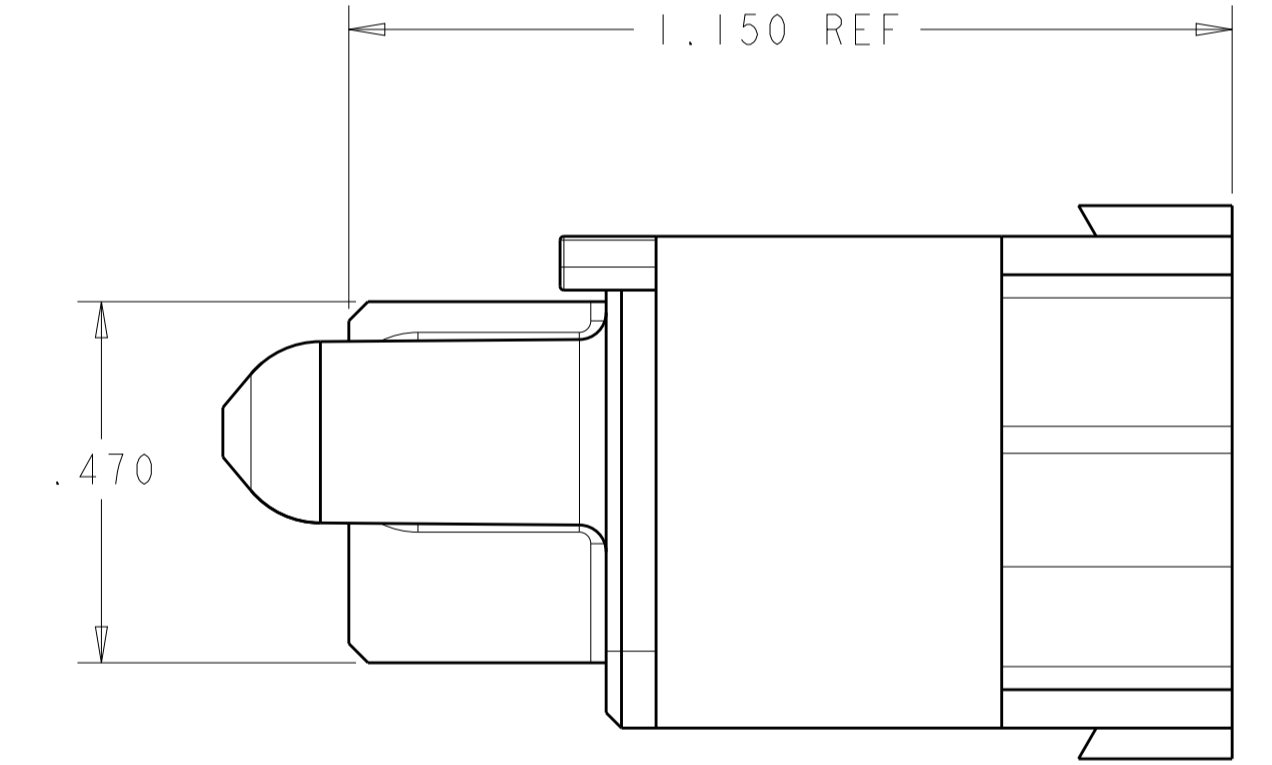
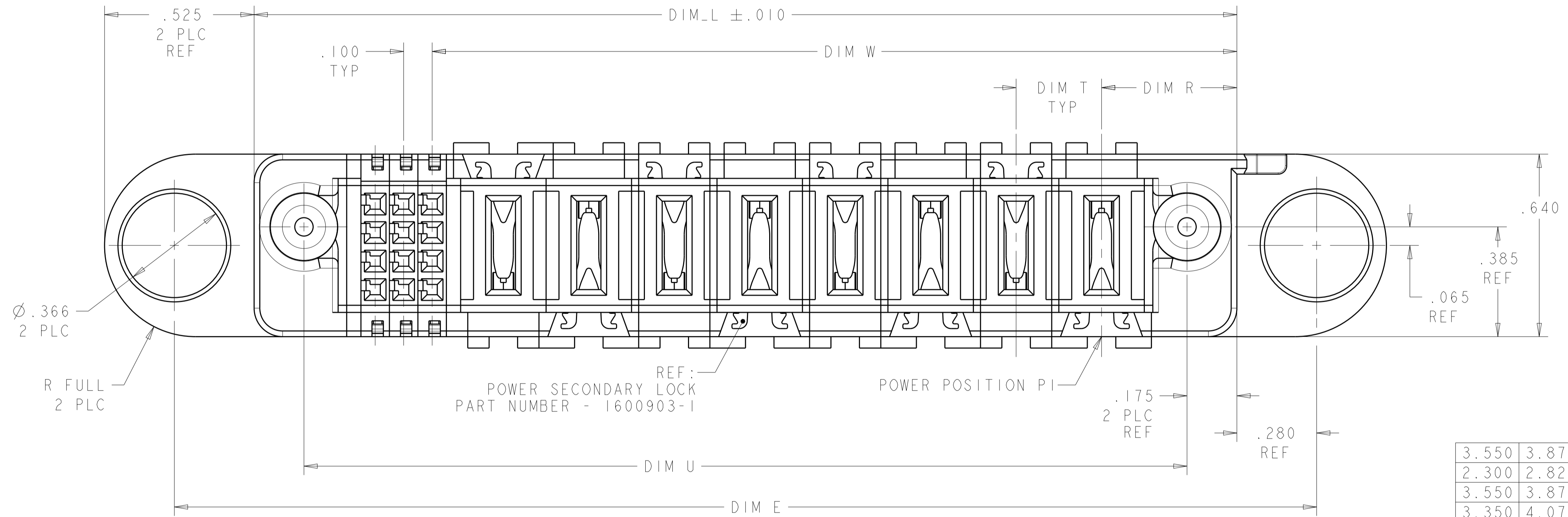

| DIM W | DIM U | DIM T | DIM R | DIM L | DIM F | DIM E | DESCRIPTION | PART NUMBER |
|-------|-------|-------|-------|-------|-------|-------|-------------------|-------------|
| 3.550 | 3.875 | 9 | .475 | 4.225 | 5.275 | 4.785 | 3ACP + 9P + 16S | 1-1600616-6 |
| 2.300 | 2.825 | 9 | .475 | 3.175 | 4.225 | 3.735 | 3ACP + 4P + 24S | 1-1600616-5 |
| 3.550 | 3.875 | 9 | .475 | 4.225 | 5.275 | 4.785 | 3ACP + 9P + 16S | 1-1600616-4 |
| 3.350 | 4.075 | 9 | .450 | 4.425 | 5.475 | 4.985 | 4ACP + 9HDP + 32S | 1-1600616-3 |
| 1.300 | 1.350 | .300 | .450 | 1.700 | 2.850 | 2.260 | 3ACP + 4S | 1-1600616-2 |
| 1.175 | 1.300 | .250 | .450 | 1.650 | 2.700 | 2.210 | 3P + 8S | 1-1600616-1 |
| 1.925 | 2.050 | .250 | .450 | 2.400 | 3.450 | 2.960 | 6P + 8S | 1-1600616-0 |
| 1.325 | 1.500 | .300 | .475 | 1.850 | 2.900 | 2.410 | 3ACP + 8S | 1600616-9 |
| 2.300 | 2.825 | 9 | .475 | 3.175 | 4.225 | 3.735 | 3ACP + 4P + 24S | 1600616-8 |
| 2.675 | 3.225 | 9 | .525 | 3.575 | 4.625 | 4.135 | 3ACP + 6P + 24S | 1600616-7 |
| 2.350 | 2.875 | 9 | .475 | 3.225 | 4.275 | 3.785 | 3ACP + 4P + 24S | 1600616-6 |
| 2.350 | 2.875 | 9 | .475 | 3.225 | 4.275 | 3.785 | 3ACP + 4P + 24S | 1600616-5 |
| 3.075 | 3.200 | .300 | .475 | 3.550 | 4.600 | 4.110 | 9ACP + 8S | 1600616-4 |
| 2.375 | 2.550 | 9 | .475 | 2.900 | 3.950 | 3.460 | 3ACP + 4P + 8S | 1600616-3 |
| 3.925 | 4.700 | .250 | .450 | 5.050 | 6.100 | 5.610 | 14P + 32S + 0P | 1600616-2 |
| 2.825 | 3.100 | .300 | .475 | 3.450 | 4.500 | 4.010 | 8ACP + 12S + 0P | 1600616-1 |

THIS DRAWING IS A CONTROLLED DOCUMENT.

DIMENSIONS: INCHES

TOLERANCES UNLESS OTHERWISE SPECIFIED:
 0 PLC ±.01
 1 PLC ±.01
 2 PLC ±.01
 3 PLC ±.005
 4 PLC ±.005
 ANGLES ±.0020

MATERIAL: 2

FINISH:

THIS DRAWING IS A CONTROLLED DOCUMENT.
 DWN: HAMMER 06 JUL 2004
 CHK: D. TROUT 09 JUL 2004
 APVD: D. TROUT
 PRODUCT SPEC: 108-2157
 APPLICATION SPEC: 114-13112
 WEIGHT: -
 CUSTOMER DRAWING

NAME: PLNEL MOUNT CABLE RECEPTACLE TYPE PS, WITH GUIDES MUTLI-BEAM XL
 SIZE: 114-13112
 CAGE CODE: 1600616
 SCALE: 4:1 SHEET 1 OF 4 REV: H5

STE TE Connectivity

| LOC | DIST | REV | DATE | BY | APPV |
|-----|------|-----|------|----|------|
| ES | 00 | | | | |

| REVISIONS | | | |
|-----------|-------------|------|----|
| NO. | DESCRIPTION | DATE | BY |
| - | SEE SHEET 1 | - | - |

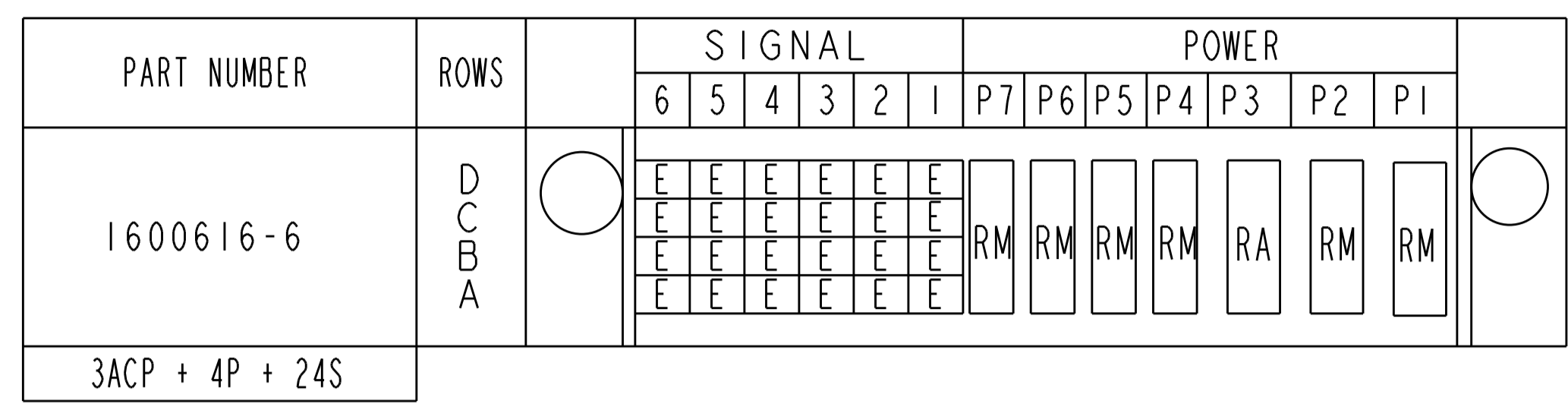
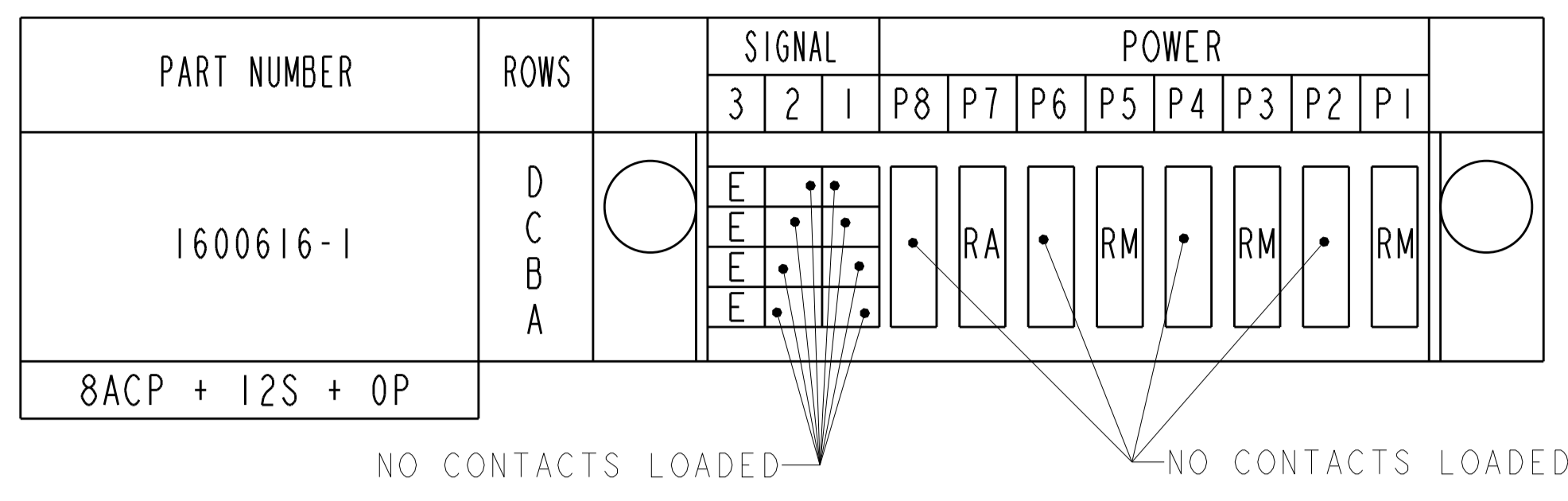

-6 HAS THE SAME DIM AS -5

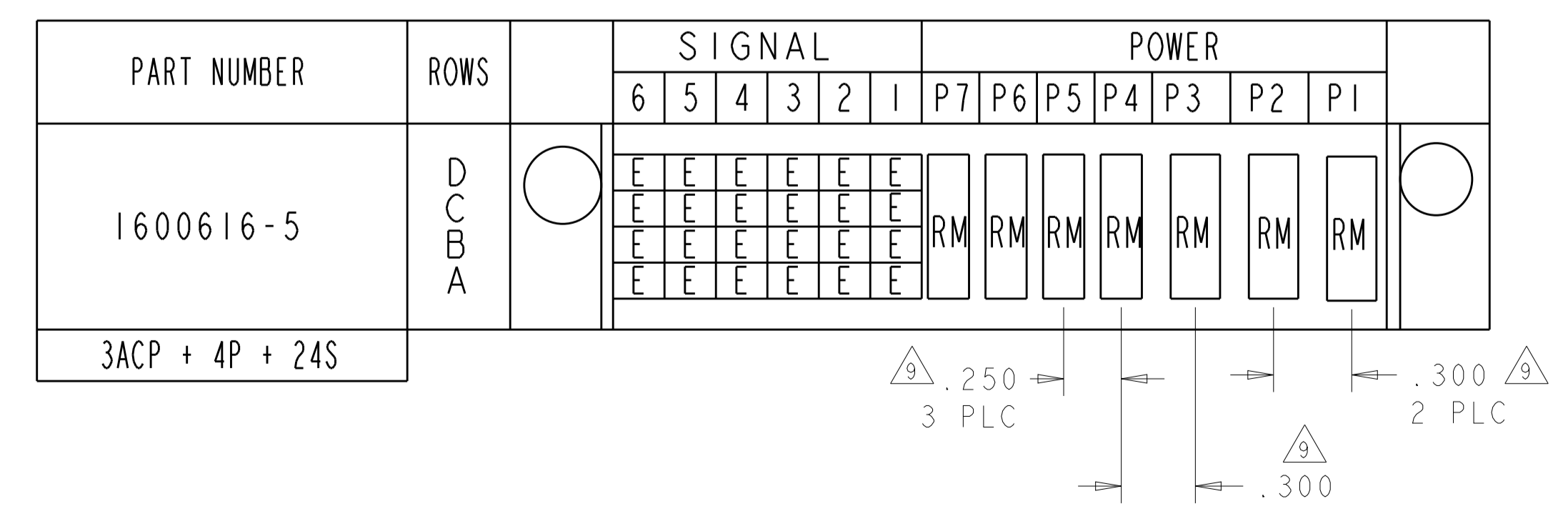
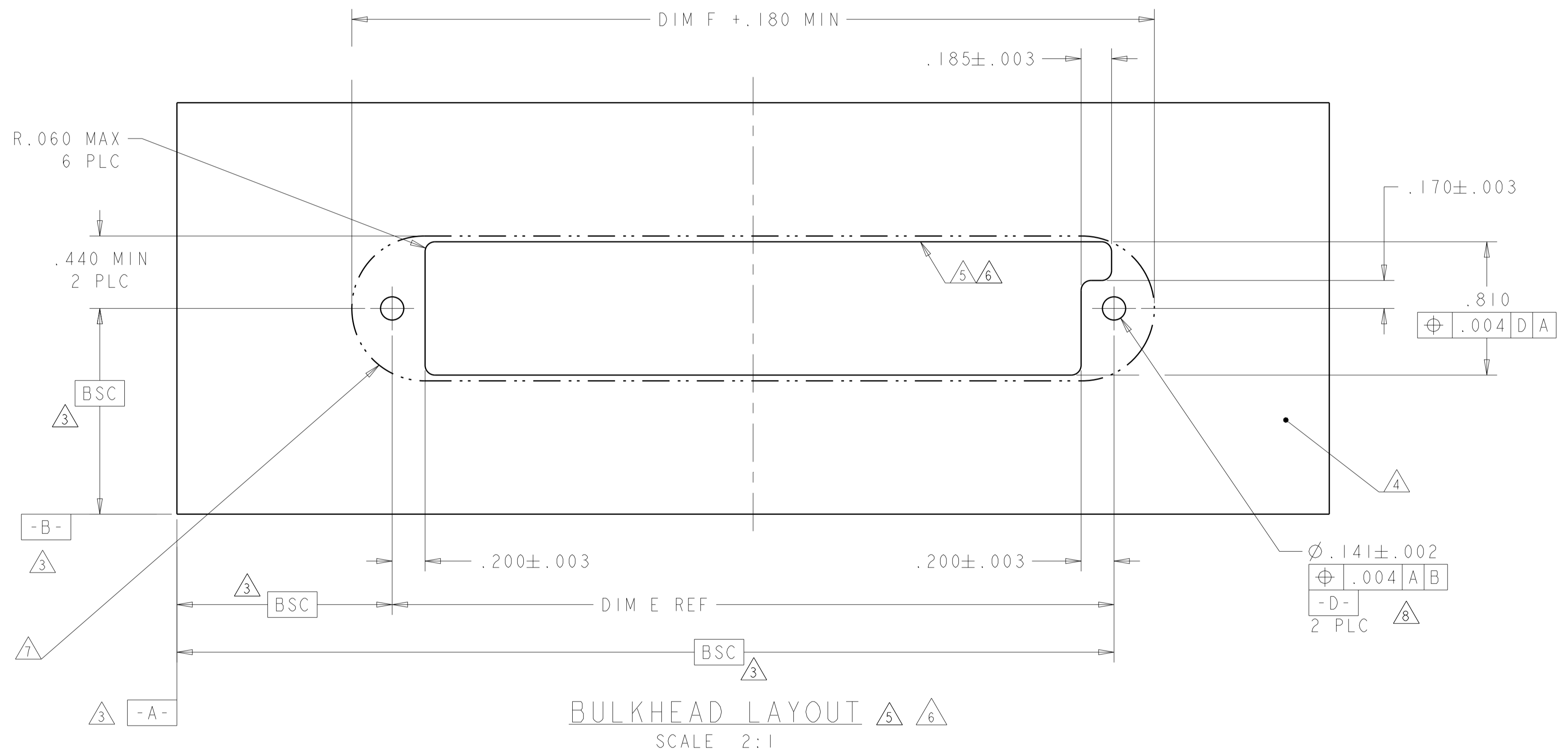
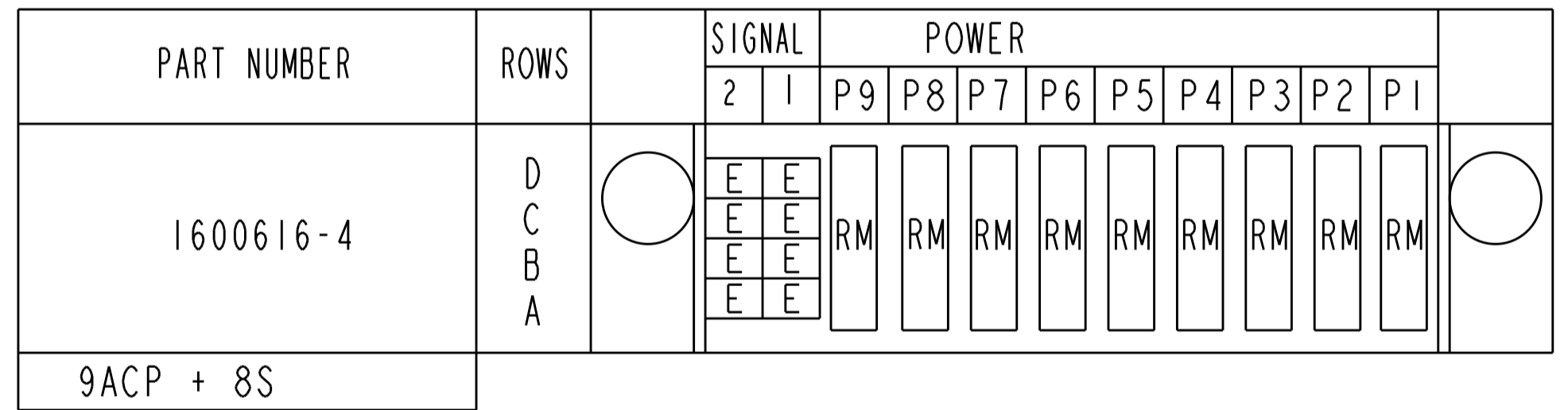
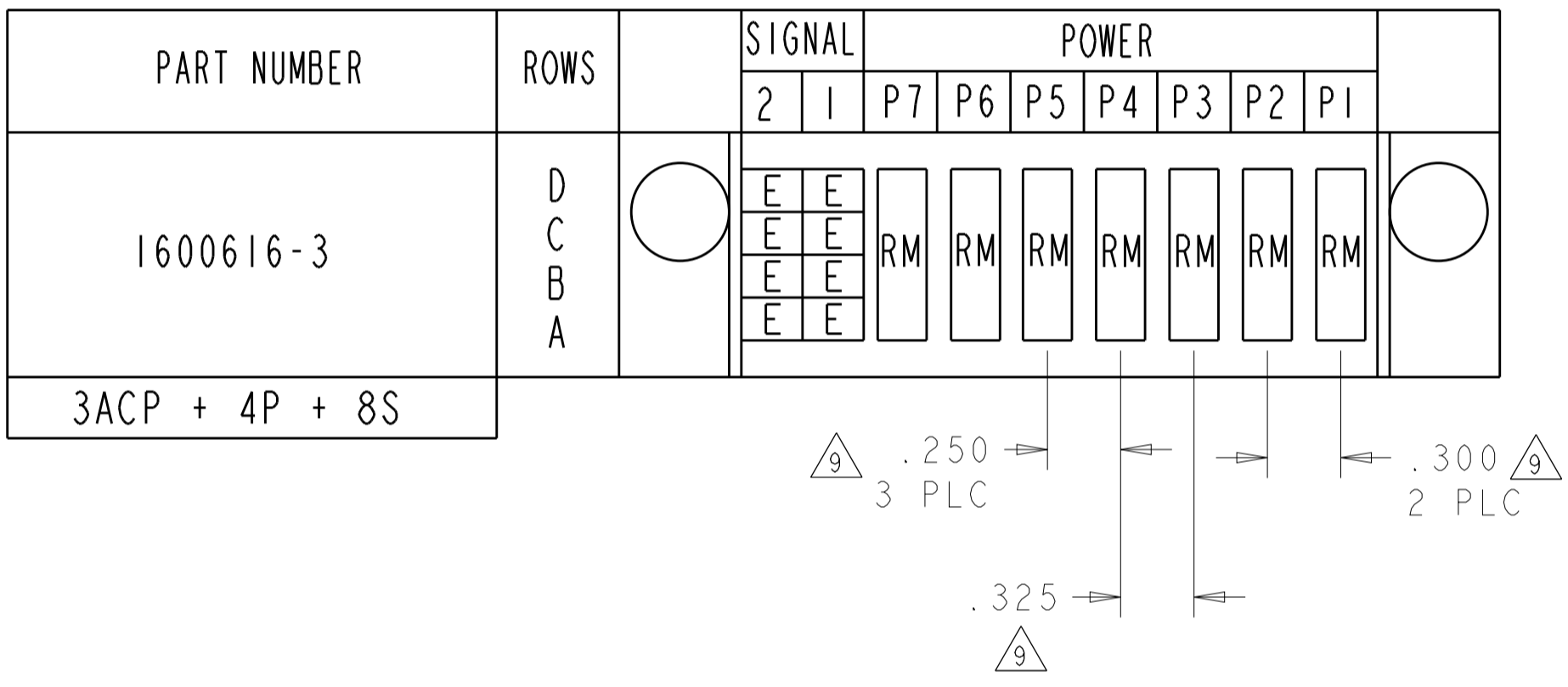
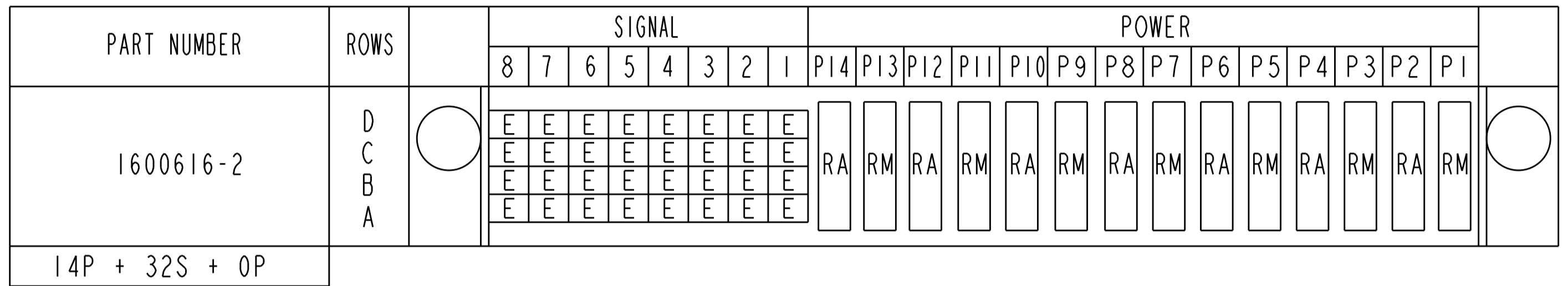

| REFERENCE WIRE CHART AND CONTACTS | | |
|-----------------------------------|-------------------------|---------------------------|
| HOUSING MODULE | CONTACT | INSULATION DIAMETER RANGE |
| .300 POWER | 8-10 1600960 REF | [.176 - .272] |
| .250 POWER | 8-10 1600960 REF | [.176 - .203] |
| | 12-14 1600961 REF | [.156 - .176] |
| .200 POWER | 12-14 1600961 REF | [.120 - .156] |
| .100 SIGNAL | 22 - 26 531216-5 REF | [.036 - .069] |

| CODE | DESCRIPTION |
|------|------------------------|
| RM | STANDARD POWER CONTACT |
| RA | MFBL POWER CONTACT |
| E | SIGNAL CONTACT |

CONTACT TABLE

THIS DRAWING IS A CONTROLLED DOCUMENT.

DIMENSIONS: INCHES

TOLERANCES UNLESS OTHERWISE SPECIFIED:
 0 PLC ±.
 1 PLC ±.01
 2 PLC ±.01
 3 PLC ±.005
 4 PLC ±.002
 ANGLES ±.2°

MATERIAL: .
FINISH: .

OWN: HAMMER 06JUL2004
CHK: D. TROUT 09JUL2004
APPV: D. TROUT
PRODUCT SPEC: 108-2157
APPLICATION SPEC: 114-13112
WEIGHT: .
CUSTOMER DRAWING

NAME: PLNEL MOUNT CABLE RECEPTACLE TYPE PS, WITH GUIDES MUTLI-BEAM XL
SIZE: A1
CAGE CODE: 1600616
DRAWING NO: 100779
SHEET 2 OF 4
REV: H5

SCALE: 4:1

| LOC | DIST | REV | DATE | BY | APPV |
|-----------|------|-----|-------------|------|------|
| ES | 00 | | | | |
| REVISIONS | | | DESCRIPTION | DATE | BY |
| | | | SEE SHEET 1 | | |

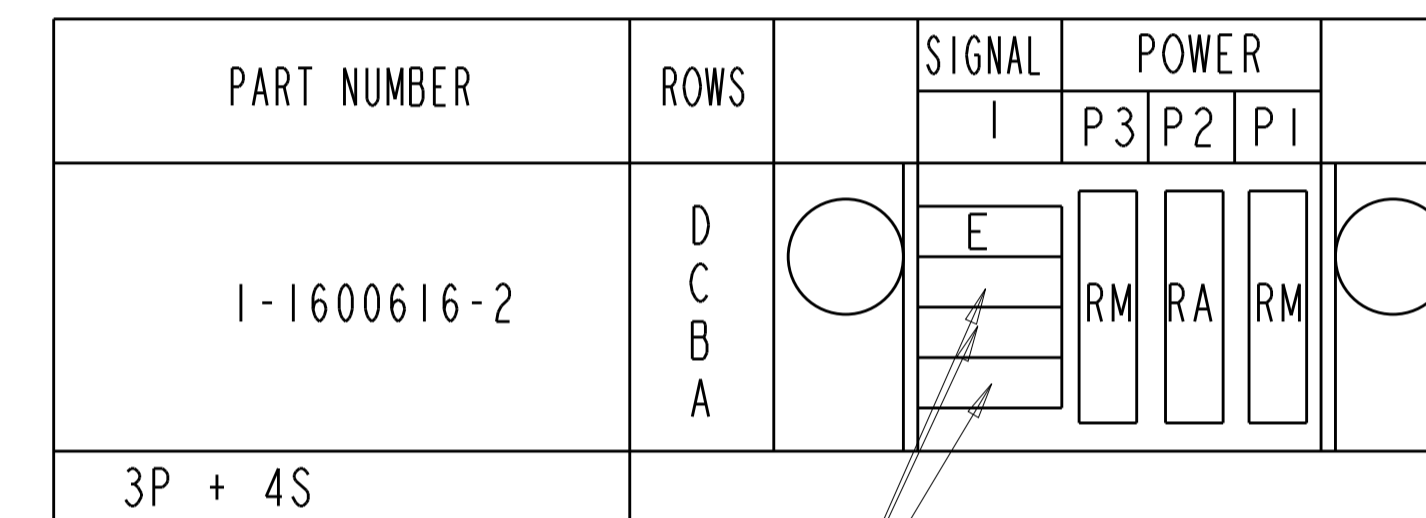
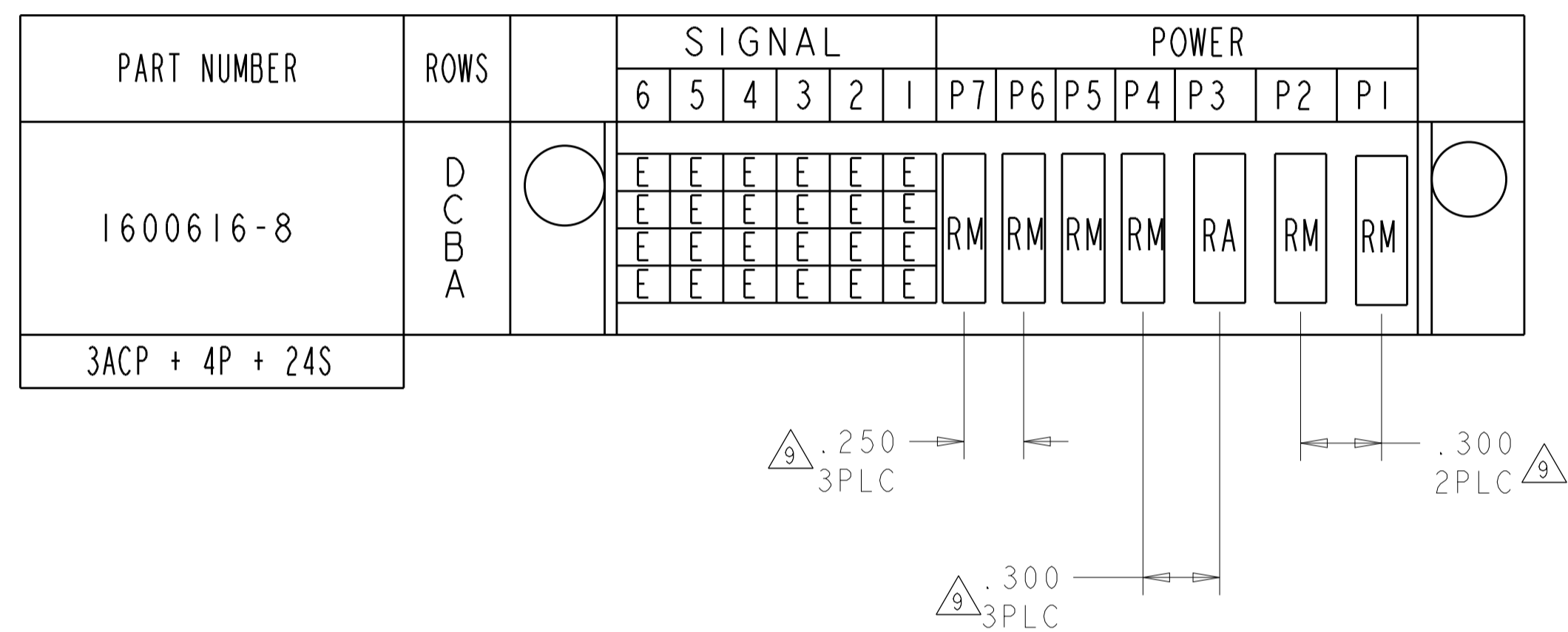
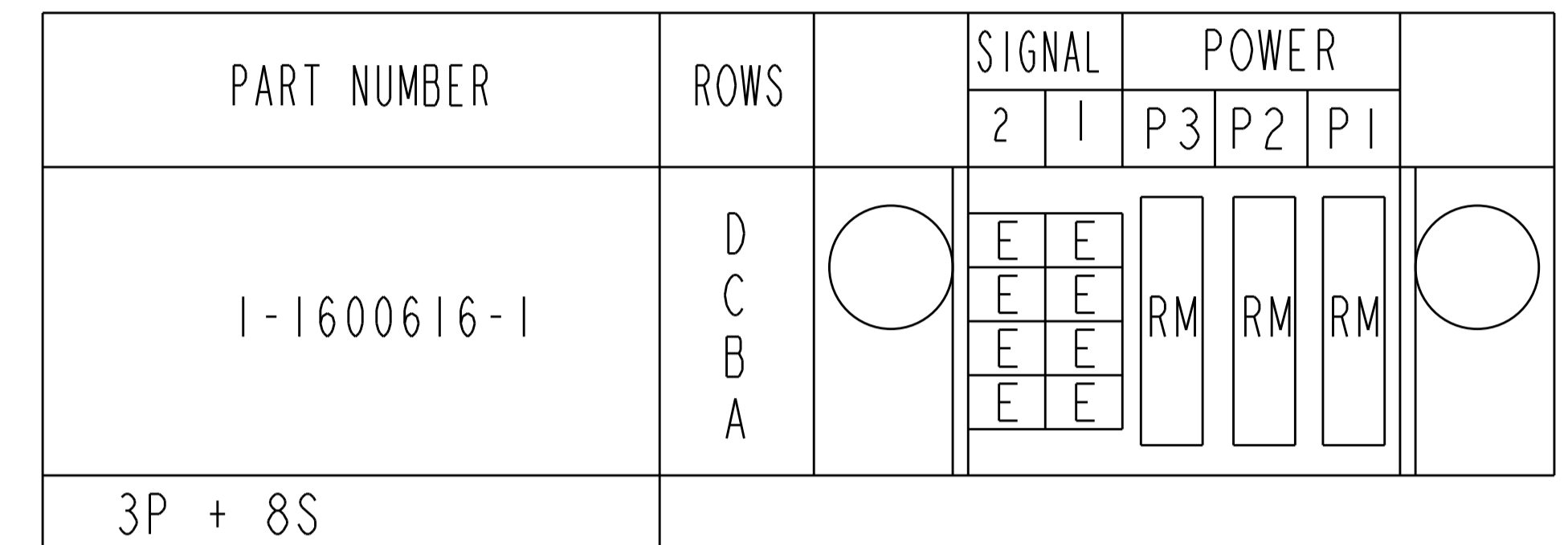
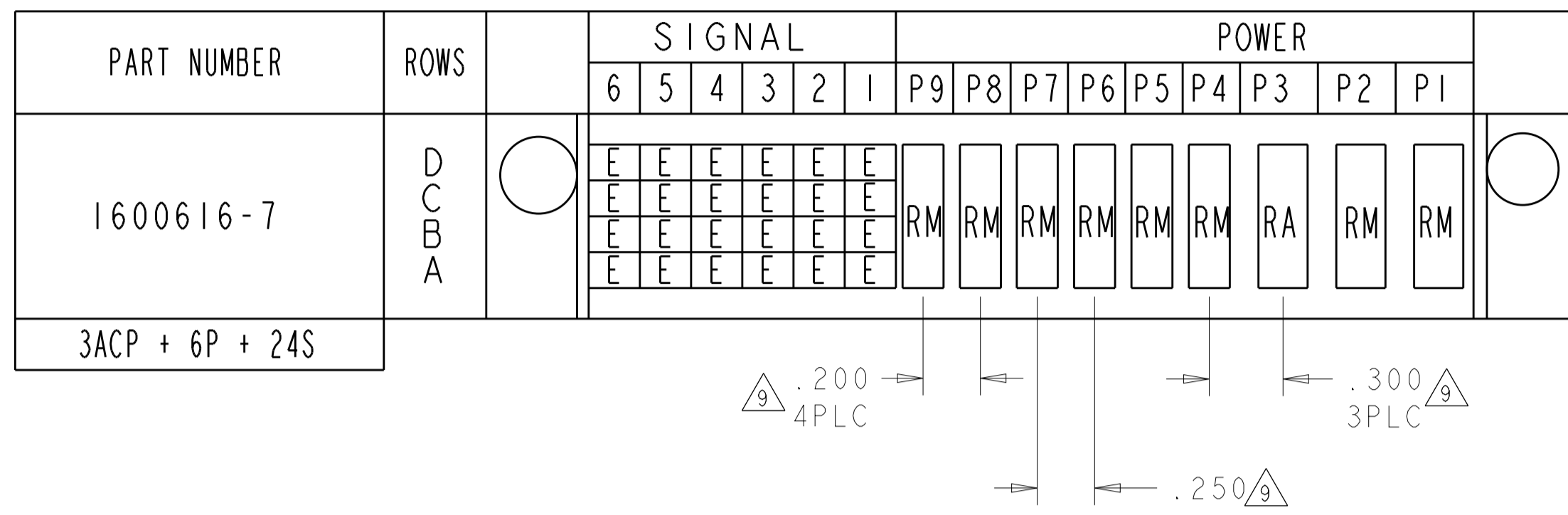

NO CONTACTS LOADED

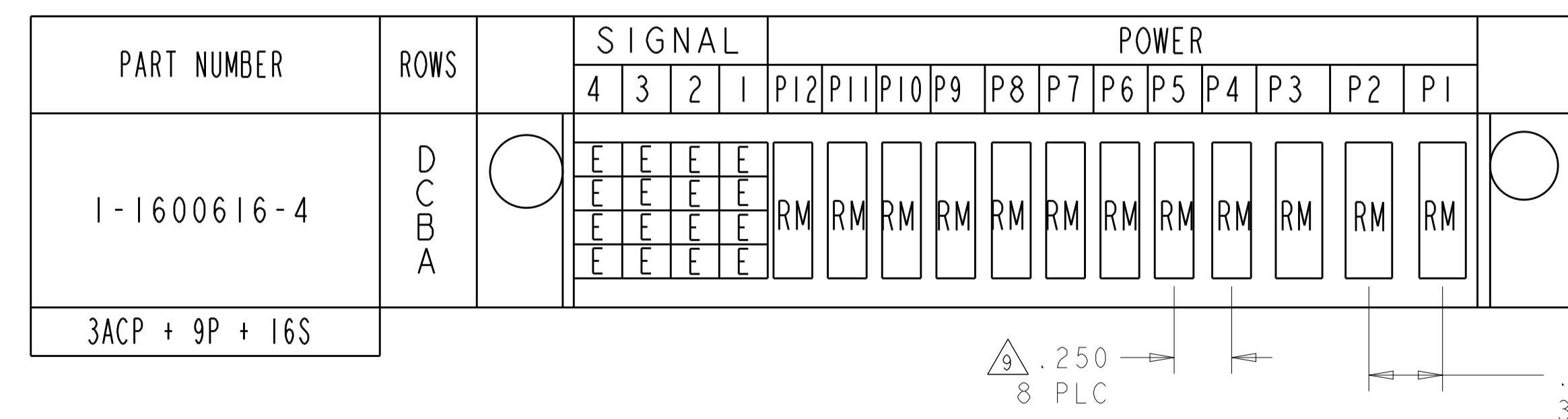
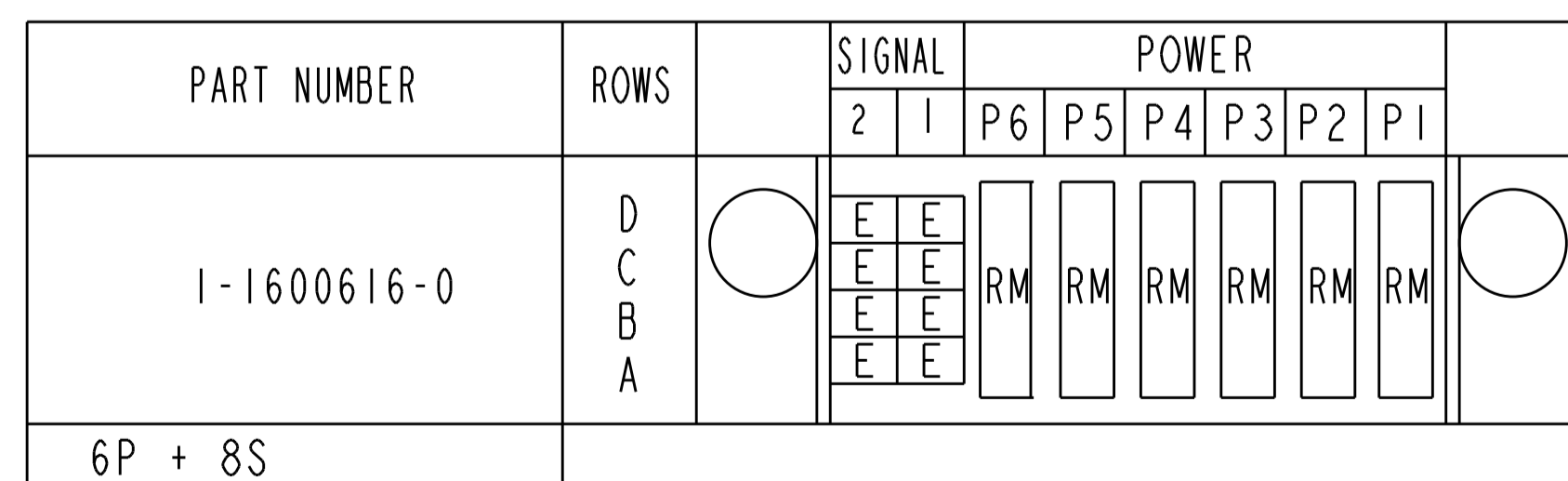
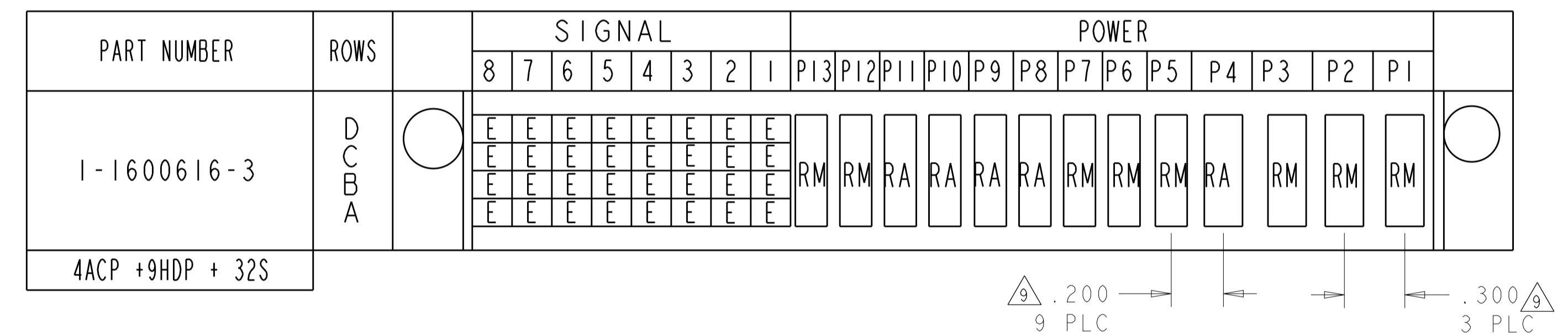
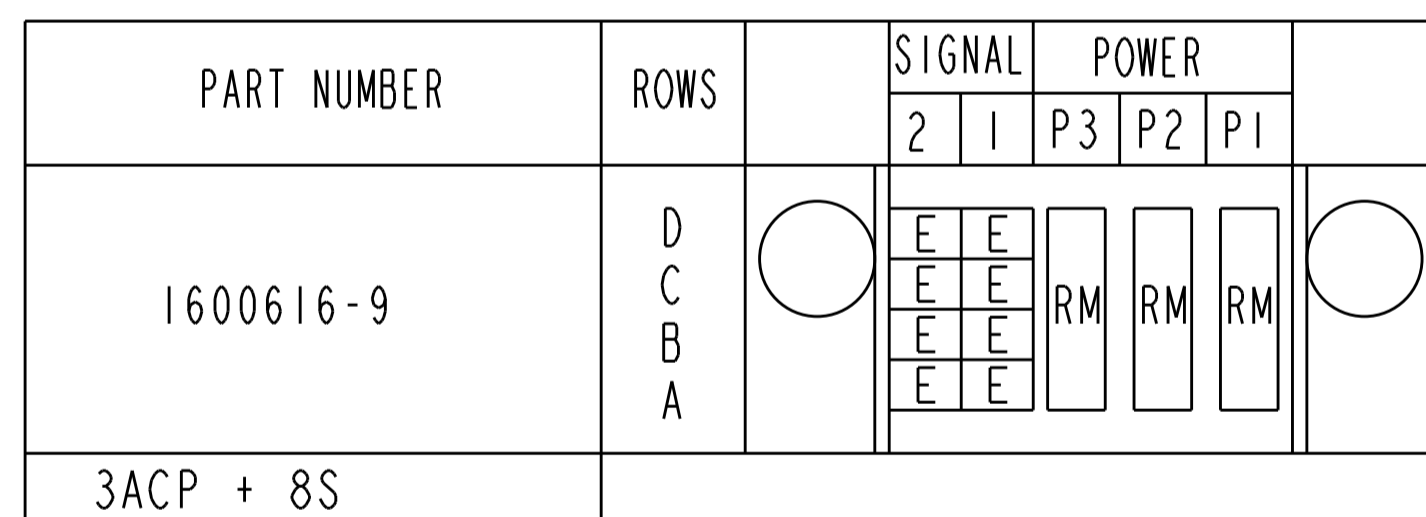

| | | | |
|---|--|-----------------------------|---|
| THIS DRAWING IS A CONTROLLED DOCUMENT. | | OWN: HAMMER 06 JUL 2004 | TE Connectivity |
| DIMENSIONS: INCHES | | CHK: D. TROUT 09 JUL 2004 | |
| TOLERANCES UNLESS OTHERWISE SPECIFIED: | | APVD: D. TROUT | NAME: PLNEL MOUNT CABLE RECEPTACLE TYPE PS, WITH GUIDES MUTLI-BEAM XL |
| 0 PLC ±.01 1 PLC ±.01 2 PLC ±.01 3 PLC ±.005 4 PLC ±.0020 ANGLES ±.020 | | PRODUCT SPEC: 108-2157 | SIZE: CAGE CODE DRAWING NO: A100779C=1600616 |
| MATERIAL: FINISH: | | APPLICATION SPEC: 114-13112 | RESTRICTED TO: - |
| | | WEIGHT: - | SCALE: 4:1 SHEET 3 OF 4 REV: H5 |
| | | CUSTOMER DRAWING | |

| PART NUMBER | ROWS | SIGNAL | | | | | | POWER | | | | | | |
|-----------------|------------------|--------|---|---|---|---|---|-------|----|----|----|----|----|----|
| | | 6 | 5 | 4 | 3 | 2 | 1 | P7 | P6 | P5 | P4 | P3 | P2 | P1 |
| I-1600616-5 | D C B A | E | E | E | E | E | E | RM | RM | RM | RM | RA | RM | RM |
| | | E | E | E | E | E | E | RM | RM | RM | RM | RA | RM | RM |
| | | E | E | E | E | E | E | RM | RM | RM | RM | RA | RM | RM |
| | | E | E | E | E | E | E | RM | RM | RM | RM | RA | RM | RM |
| 3ACP + 4P + 24S | | | | | | | | | | | | | | |

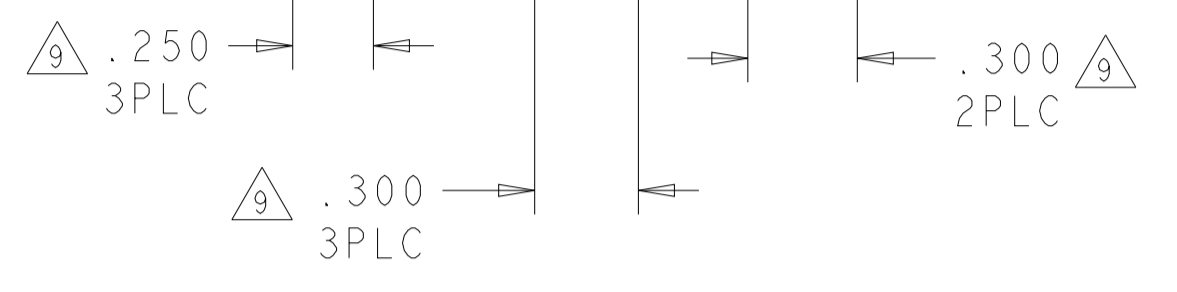

| PART NUMBER | ROWS | SIGNAL | | | | POWER | | | | | | | | | | | | |
|-----------------|------------------|--------|---|---|---|-------|-----|-----|----|----|----|----|----|----|----|----|----|----|
| | | 4 | 3 | 2 | 1 | PI2 | PI1 | PI0 | P9 | P8 | P7 | P6 | P5 | P4 | P3 | P2 | P1 | |
| I-1600616-6 | D C B A | E | E | E | E | RM | RM | RM | RM | RM | RM | RM | RM | RM | RM | RM | RM | |
| | | E | E | E | E | RM | RM | RM | RM | RM | RM | RM | RM | RM | RM | RM | RM | |
| | | E | E | E | E | RM | RM | RM | RM | RM | RM | RM | RM | RM | RM | RM | RM | RM |
| | | E | E | E | E | RM | RM | RM | RM | RM | RM | RM | RM | RM | RM | RM | RM | RM |
| 3ACP + 9P + 16S | | | | | | | | | | | | | | | | | | |

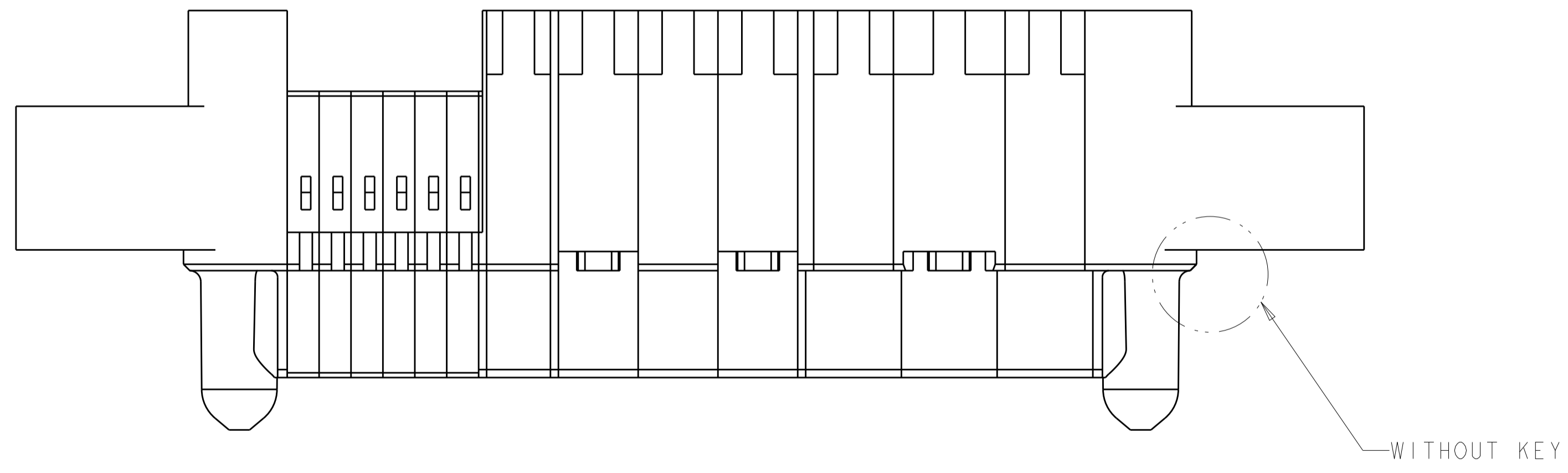
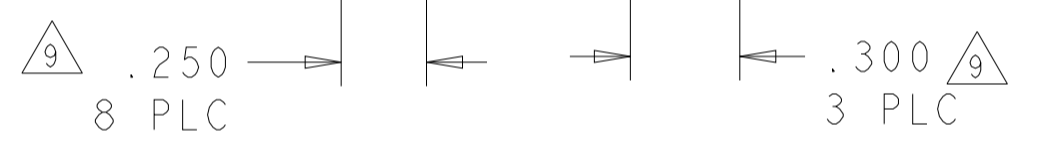

FOR THE CONFIGURATION WITHOUT KEY
 PART NUMBER: I-1600616-5, I-1600616-6

| | | | |
|--|--|--|---|
| THIS DRAWING IS A CONTROLLED DOCUMENT. | | DWN HAWMER 06 JUL 2004 | |
| DIMENSIONS: INCHES | | CHK D. TROUT 09 JUL 2004 | |
| | | TOLERANCES UNLESS OTHERWISE SPECIFIED: | NAME PLNEL MOUNT CABLE RECEPTACLE TYPE PS, WITH GUIDES MULTI-BEAM XL |
| MATERIAL | | APVD D. TROUT | PRODUCT SPEC |
| FINISH | | APPLICATION SPEC | SIZE A1 |
| | | WEIGHT | CAGE CODE 1600616 |
| | | CUSTOMER DRAWING | RESTRICTED TO |
| | | SCALE 4:1 | SHEET 4 OF 4 |
| | | | REV H5 |