



Chipsmall Limited consists of a professional team with an average of over 10 year of expertise in the distribution of electronic components. Based in Hongkong, we have already established firm and mutual-benefit business relationships with customers from,Europe,America and south Asia,supplying obsolete and hard-to-find components to meet their specific needs.

With the principle of “Quality Parts,Customers Priority,Honest Operation,and Considerate Service”,our business mainly focus on the distribution of electronic components. Line cards we deal with include Microchip,ALPS,ROHM,Xilinx,Pulse,ON,Everlight and Freescale. Main products comprise IC,Modules,Potentiometer,IC Socket,Relay,Connector.Our parts cover such applications as commercial,industrial, and automotives areas.

We are looking forward to setting up business relationship with you and hope to provide you with the best service and solution. Let us make a better world for our industry!



Contact us

Tel: +86-755-8981 8866 Fax: +86-755-8427 6832

Email & Skype: info@chipsmall.com Web: www.chipsmall.com

Address: A1208, Overseas Decoration Building, #122 Zhenhua RD., Futian, Shenzhen, China



Device connector, front mounting - ST-5ES1N8AAD00S - 1607726

Please be informed that the data shown in this PDF Document is generated from our Online Catalog. Please find the complete data in the user's documentation. Our General Terms of Use for Downloads are valid (<http://phoenixcontact.com/download>)



Device connector, front mounting, angled rotatable, SPEEDCON locking, M17, Number of positions: 5+PE, Type of contact: Socket, Crimp connection, Axial O-ring, 4xØ2,7, shielded: yes, Flange dimensions: 21.6 mm x 21.6 mm

The figure shows the 4-pos. (3+PE) product version



Key Commercial Data

Packing unit	1 STK
Weight per Piece (excluding packing)	1.060 g
Custom tariff number	85366990
Country of origin	Germany

Technical data

General

Note	Order information: Order crimp contacts Ø 1 mm separately
Type of locking	SPEEDCON locking
Direction of rotation of contact chamber numbering	Standard
Coding	N
Contact connection method	Crimp connection
Type of contacts	Socket
Number of positions	6
Contact diameter of power contacts	1 mm
Nominal current per power contact at 25°C	14 A
Contact diameter of signal contacts	1 mm
Pg housing screw connection	none
Mounting type	4xØ2,7

Device connector, front mounting - ST-5ES1N8AAD00S - 1607726

Technical data

Ambient conditions

Ambient temperature	-40 °C ... 125 °C
Degree of protection	IP67

Material

Housing material	Turned parts: copper zinc alloy (CuZn), die-cast parts: zinc (GD-Zn)
Insulator material	PA 66
Gasket and O-ring material	FPM

Specifications according to DIN EN 61984:2001

Installation height max.	3000 m
Nominal / operating voltage of power contacts	630 V
Rated surge voltage of power contacts	6 kV
Overvoltage category of power contacts	III
Degree of pollution of power contacts	3

Drawings

Schematic diagram



Connector pin assignment

Diagram

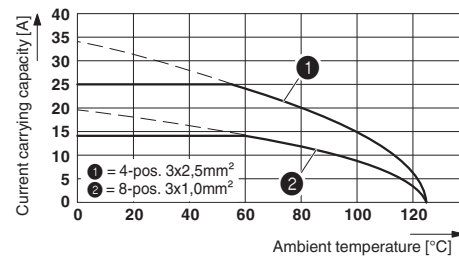

Diagram

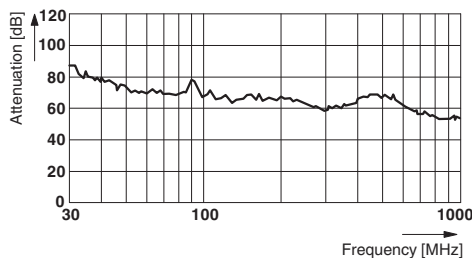

Dimensional drawing

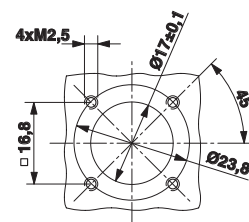

Device connector, front mounting - ST-5ES1N8AAD00S - 1607726

Dimensional drawing

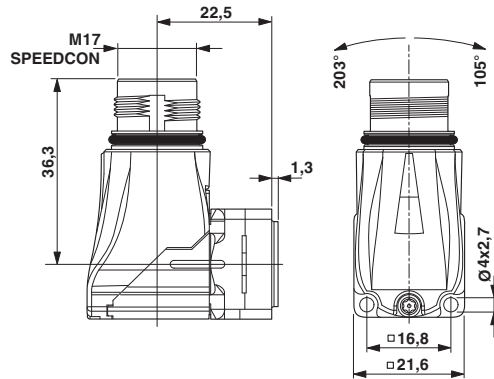

Classifications

eCl@ss

eCl@ss 4.0	272607xx
eCl@ss 4.1	27260701
eCl@ss 5.0	27143424
eCl@ss 5.1	27143424
eCl@ss 6.0	27143424
eCl@ss 7.0	27440209
eCl@ss 8.0	27440102
eCl@ss 9.0	27440103

ETIM

ETIM 3.0	EC001121
ETIM 4.0	EC001121
ETIM 5.0	EC002635

UNSPSC

UNSPSC 6.01	43172015
UNSPSC 7.0901	43201404
UNSPSC 11	43172015
UNSPSC 12.01	43201404
UNSPSC 13.2	43201404

Approvals

Approvals

Device connector, front mounting - ST-5ES1N8AAD00S - 1607726

Approvals

Approvals

UL Recognized / cUL Recognized / EAC / cULus Recognized

Ex Approvals

Approval details

UL Recognized  http://database.ul.com/cgi-bin/XYV/template/LISEXT/1FRAME/index.htm FILE E 335019	
mm ² /AWG/kcmil	1.0
Nominal current I _N	6 A
Nominal voltage U _N	600 V

cUL Recognized  http://database.ul.com/cgi-bin/XYV/template/LISEXT/1FRAME/index.htm FILE E 335019	
mm ² /AWG/kcmil	1.0
Nominal current I _N	6 A
Nominal voltage U _N	600 V

EAC B.01742

cULus Recognized  http://database.ul.com/cgi-bin/XYV/template/LISEXT/1FRAME/index.htm
--