



Chipsmall Limited consists of a professional team with an average of over 10 year of expertise in the distribution of electronic components. Based in Hongkong, we have already established firm and mutual-benefit business relationships with customers from,Europe,America and south Asia,supplying obsolete and hard-to-find components to meet their specific needs.

With the principle of “Quality Parts,Customers Priority,Honest Operation,and Considerate Service”,our business mainly focus on the distribution of electronic components. Line cards we deal with include Microchip,ALPS,ROHM,Xilinx,Pulse,ON,Everlight and Freescale. Main products comprise IC,Modules,Potentiometer,IC Socket,Relay,Connector.Our parts cover such applications as commercial,industrial, and automotives areas.

We are looking forward to setting up business relationship with you and hope to provide you with the best service and solution. Let us make a better world for our industry!



Contact us

Tel: +86-755-8981 8866 Fax: +86-755-8427 6832

Email & Skype: info@chipsmall.com Web: www.chipsmall.com

Address: A1208, Overseas Decoration Building, #122 Zhenhua RD., Futian, Shenzhen, China



Patch cable - VS-04-2X2X26C7/7-67A/SDB/5,0 - 1653906

Please be informed that the data shown in this PDF Document is generated from our Online Catalog. Please find the complete data in the user's documentation. Our General Terms of Use for Downloads are valid (<http://download.phoenixcontact.com>)



Assembled USB cable, shielded, color: RAL 5021 (water blue), PUR outer sheath, USB type A/IP67 on USB type B/standard, length: 5 m



Key commercial data

Packing unit	1 pc
GTIN	 4 017918 970239
Weight per Piece (excluding packing)	369.7 GRM
Custom tariff number	85444290
Country of origin	Germany

Technical data

Mechanical characteristics

Number of positions	4
Shielded	Yes
Insertion/withdrawal cycles	≥ 500
Cable diameter	6.70 mm
Cable structure	2x2xAWG26/7 + 2xAWG20/19; S/FTP
Length of cable	5 m

Ambient conditions

Ambient temperature (operation)	-20 °C ... 60 °C (cable, fixed installation)
	0 °C ... 50 °C (cable, flexible installation)
	(Plug / socket)
Degree of protection	IP67/IP20

Material data

Patch cable - VS-04-2X2X26C7/7-67A/SDB/5,0 - 1653906

Technical data

Material data

Housing material	PA
Sealing material	NBR
Material, O-ring	FPM
Outer sheath, material	PUR
External sheath, color	water blue RAL 5021

Electrical characteristics

Rated voltage (III/3)	125 V
Rated current	1 A
Transmission characteristics (category)	USB 2.0

Line characteristics

Cable type	FireWire
Cable structure	2x2xAWG26/7 + 2xAWG20/19; S/FTP
Conductor cross section	2x 2x 0.14 mm ² (signal line) 2x 0.5 mm ² (Power supply)
AWG signal line	26
Conductor structure signal line	7x 0.15 mm
AWG power supply	20
Conductor structure, voltage supply	19x 0.20 mm
Core diameter including insulation	≤ 1.05 mm (signal line) nom. 1.4 mm (Power supply)
External cable diameter	6.7 mm
Wire colors	White-blue, white-orange, white, black
External sheath, color	water blue RAL 5021
Insulation resistance	5 GΩ*km
Conductor resistance	150 Ω/km
Transmission characteristics (category)	CAT7, for USB 2.0 (480 Mbps)
Working capacitance	42 pF (per meter)
Wave impedance	100 Ω ±5 % (at 100 MHz)
Signal speed	0.72 c
Signal runtime	4.6 ns/m
Shield attenuation	60 dB (Up to 1000 MHz)
Interference suppression	90 dB (Up to 1000 MHz)
Coupling resistance	5.00 mΩ/m (At 10 MHz)
Nominal voltage, cable	≤ 125 V
Test voltage, cable	1000 V
Twisted pairs	2 cores to the pair

Patch cable - VS-04-2X2X26C7/7-67A/SDB/5,0 - 1653906

Technical data

Line characteristics

Type of pair shielding	Aluminum-lined polyester foil
Overall twist	Two pairs and two power supply wires to the core
Shielding	Tinned copper braided shield
Outer sheath, material	PUR
Material conductor insulation	Cell PE (signal line)
	PVC (Power supply)
Conductor material	Bare Cu litz wires
Cable weight	59 kg/km
Minimum bending radius, fixed installation	5 x D
Minimum bending radius, flexible installation	5 x D
Tensile strength short-term/long-term	≤ 30 N
Special properties	Free of substances which would hinder coating with paint or varnish
Flame resistance	complying with IEC 60332-2-2
Resistance to oil	according to EN 60811-2-1
Other resistance	Microbe resistance as per DIN VDE 0282
	Hydrolysis resistance as per DIN 53504
Ambient temperature (operation)	-40 °C ... 70 °C (cable, fixed installation)
	-10 °C ... 50 °C (cable, flexible installation)

Classifications

eCl@ss

eCl@ss 4.0	27140816
eCl@ss 4.1	27260701
eCl@ss 5.0	27260701
eCl@ss 5.1	27260701
eCl@ss 6.0	27279218
eCl@ss 7.0	27279218
eCl@ss 8.0	27279218

ETIM

ETIM 2.0	EC000830
ETIM 3.0	EC001855
ETIM 4.0	EC001855
ETIM 5.0	EC001855

UNSPSC

UNSPSC 6.01	31261501
-------------	----------

Patch cable - VS-04-2X2X26C7/7-67A/SDB/5,0 - 1653906

Classifications

UNSPSC

UNSPSC 7.0901	31261501
UNSPSC 11	31261501
UNSPSC 12.01	31261501
UNSPSC 13.2	31261501

Drawings

Schematic diagram

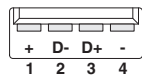

Pin assignment plug USB, type A

Schematic diagram

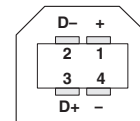

Plug pin assignment plug USB, type B

Dimensioned drawing

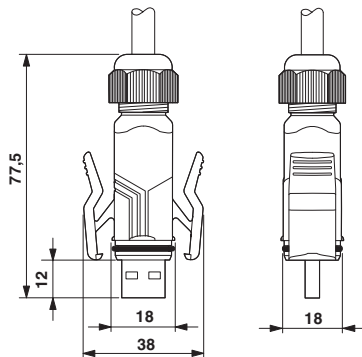

USB connector, type A, IP67

Dimensioned drawing

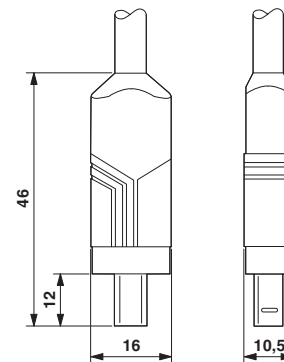

USB connector, type B, standard

Circuit diagram

