



Chipsmall Limited consists of a professional team with an average of over 10 year of expertise in the distribution of electronic components. Based in Hongkong, we have already established firm and mutual-benefit business relationships with customers from,Europe,America and south Asia,supplying obsolete and hard-to-find components to meet their specific needs.

With the principle of “Quality Parts,Customers Priority,Honest Operation,and Considerate Service”,our business mainly focus on the distribution of electronic components. Line cards we deal with include Microchip,ALPS,ROHM,Xilinx,Pulse,ON,Everlight and Freescale. Main products comprise IC,Modules,Potentiometer,IC Socket,Relay,Connector.Our parts cover such applications as commercial,industrial, and automotives areas.

We are looking forward to setting up business relationship with you and hope to provide you with the best service and solution. Let us make a better world for our industry!



## Contact us

Tel: +86-755-8981 8866 Fax: +86-755-8427 6832

Email & Skype: info@chipsmall.com Web: www.chipsmall.com

Address: A1208, Overseas Decoration Building, #122 Zhenhua RD., Futian, Shenzhen, China



## Front plate - VS-SI-FP-2DSUB25-GC-BU/ST - 1657753

Please be informed that the data shown in this PDF Document is generated from our Online Catalog. Please find the complete data in the user's documentation. Our General Terms of Use for Downloads are valid (<http://download.phoenixcontact.com>)

Front plate with contact inserts, plastic, 2x D-SUB 25, socket/pin



Illustration shows the product version  
VS-SI-FP-2RJ45-5-MOD-BU/BU



### Key commercial data

Packing unit	1 pc
Weight per Piece (excluding packing)	52.8 GRM
Custom tariff number	85366990
Country of origin	Czech Republic

### Technical data

#### Mechanical characteristics

Number of slots	2
Color	gray

#### Ambient conditions

Ambient temperature (operation)	-10 °C ... 60 °C
Degree of protection	IP20

#### Material data

Inflammability class according to UL 94	V0
Housing material	PBT

#### Electrical characteristics

Rated voltage (III/3)	125 V
Rated current	3 A

# Front plate - VS-SI-FP-2DSUB25-GC-BU/ST - 1657753

## Classifications

### eCl@ss

eCl@ss 4.0	27140816
eCl@ss 4.1	27140816
eCl@ss 5.0	27189239
eCl@ss 5.1	27189239
eCl@ss 6.0	27144001
eCl@ss 7.0	27144001
eCl@ss 8.0	27144001

### ETIM

ETIM 2.0	EC000007
ETIM 3.0	EC000007
ETIM 4.0	EC000007
ETIM 5.0	EC000456

### UNSPSC

UNSPSC 6.01	31261501
UNSPSC 7.0901	31261501
UNSPSC 11	31261501
UNSPSC 12.01	31261501
UNSPSC 13.2	31261501

## Approvals

### Approvals

---

Approvals

GOST

---

Ex Approvals

---

Approvals submitted

---

Approval details

# Front plate - VS-SI-FP-2DSUB25-GC-BU/ST - 1657753

## Approvals



## Accessories

Accessories

Marking material

Marker labels - VS-SI-BZ - 1656660



Marker label, plastic, plate with 20 labels

## Drawings

Dimensioned drawing

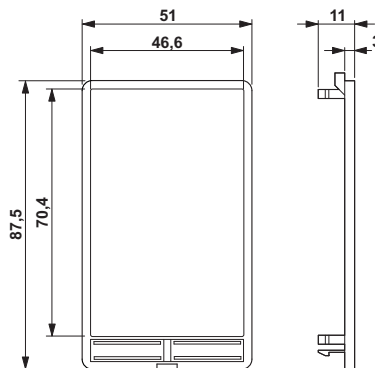

Front plate