



Chipsmall Limited consists of a professional team with an average of over 10 year of expertise in the distribution of electronic components. Based in Hongkong, we have already established firm and mutual-benefit business relationships with customers from,Europe,America and south Asia,supplying obsolete and hard-to-find components to meet their specific needs.

With the principle of "Quality Parts,Customers Priority,Honest Operation,and Considerate Service",our business mainly focus on the distribution of electronic components. Line cards we deal with include Microchip,ALPS,ROHM,Xilinx,Pulse,ON,Everlight and Freescale. Main products comprise IC,Modules,Potentiometer,IC Socket,Relay,Connector.Our parts cover such applications as commercial,industrial, and automotives areas.

We are looking forward to setting up business relationship with you and hope to provide you with the best service and solution. Let us make a better world for our industry!



## Contact us

Tel: +86-755-8981 8866 Fax: +86-755-8427 6832

Email & Skype: info@chipsmall.com Web: www.chipsmall.com

Address: A1208, Overseas Decoration Building, #122 Zhenhua RD., Futian, Shenzhen, China



## Description

Very cost effective design to meet international requirements. No exposed metal parts which are, or could become, current-carrying except for terminals. R-type TO CBE to EN 60934.

- Manual reset, cycling trip free mechanism
- Extremely small and lightweight
- UL, CSA, VDE and EN 60934 (IEC 60934) approved

## Typical applications

Battery chargers, consumer products, power supplies, motors.

## Ordering information

### Type No.

1658 single pole thermal circuit breaker

### Threadneck design

G21	manual reset type, 3/8"-27 threadneck
G41	manual reset type, 7/16"-28 threadneck
E00	manual reset without threadneck
F01	snap-in type
F02	press to reset, snap-in type
A21	auto reset type, 3/8"-27 threadneck
A41	auto reset type, 7/16"-28 threadneck
A00	auto reset type, without threadneck
A01	auto reset, snap-in type

### Hardware

configuration	bulk		mounted	
	hex nut	knurled nut	hex nut	knurled nut
00	0	0	0	0
01	1 (PAL)	0	0	0
02	1 (PAL)	1	0	0
03	0	0	1 (PAL)	0
04	0	0	1 (PAL)	1
05	0	1	1 (PAL)	0
06	0	1	0	0
07	1	0	0	0
08	2	0	0	0
09	1	1	0	0
10	0	0	0	1
12 (3/8-27 UNS)	1 (PAL)	1 (plastic)	0	0
14 (3/8-27 UNS)	0	0	1 (PAL)	1 (plastic)
15 (3/8-27 UNS)	0	1 (plastic)	1 (PAL)	0
16 (3/8-27 UNS)	0	1 (plastic)	0	0
19 (3/8-27 UNS)	1	1 (plastic)	0	0
20 (3/8-27 UNS)	0	0	0	1 (plastic)

### Terminals

P10	blade terminals A6.3-0.8 (QC .250)
P13	blade terminals A6.3-0.8 (QC .250), 90°
S80	straight screw terminals*
S83	90° bent screw terminals*

**Current ratings**  
5 ... 30 A

1658 - G21 - 02 - P10 - 5 A Ordering example

\* Screws and lock washers bulk shipped

## Standard current ratings and typical voltage drop values

Current rating (A)	Voltage drop (mV)	Current rating (A)	Voltage drop (mV)
5	≤ 150	12	≤ 140
6	≤ 150	15	≤ 240
7	≤ 150	16	≤ 240
8	≤ 150	20	≤ 240
9	≤ 150	25	≤ 240
10	≤ 140	30	≤ 240

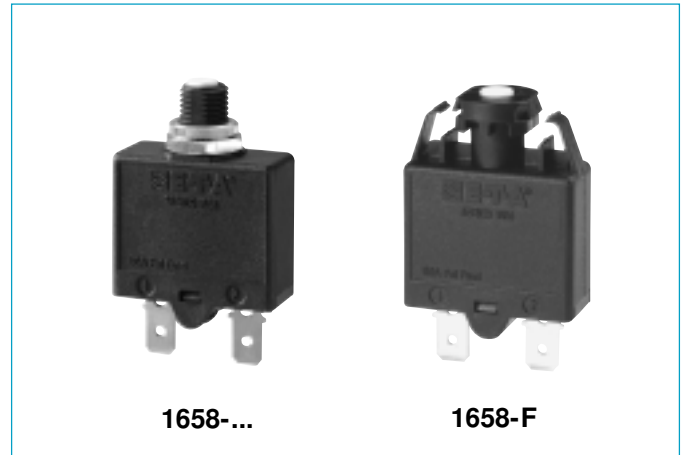

## Technical data

Voltage rating	AC 240 V; DC 28 V		
Current ratings	5...30 A		
Typical life	1,000 operations at 2 x I <sub>N</sub>		
Ambient temperature	-20...+60 °C (-4...+140 °F), <8A max. +40 °C (104 °F)		
Insulation co-ordination (IEC 60664 and 60664 A)	Rated impulse withstand voltage 2.5 kV	Pollution degree 2	reinforced insulation in operating area
Dielectric strength (IEC 60664 and 60664A) operating area	Test voltage AC 3,000 V		
Insulation resistance	> 100 MΩ (DC 500 V)		
Interrupting capacity I <sub>cn</sub>	200 A		
Interrupting capacity (UL 1077/EN 60934 PC1)	I <sub>N</sub>	U <sub>N</sub>	
	5...16 A	AC 240 V	2,000 A
	18...30 A	AC 120 V	2,000 A
	5...30 A	DC 28 V	2,000 A
Degree of protection (IEC 60529/DIN 40050)	operating area IP 40 terminal area IP 00		
Vibration	8 g (57-500 Hz) ±0.61 mm (10-57 Hz), to IEC 60068-2-6, Test Fc, 10 frequency cycles/axis		
Shock	30 g (11 ms) to IEC 60068-2-27, test Ea		
Corrosion	96 hours at 5 % salt mist, to IEC 60068-2-11, test Ka		
Humidity	240 hours at 95 % RH to IEC 60068-2-3, test Ca		
Mass	approx. 16 g		

## Approvals

Authority	Voltage rating	Current ratings	
VDE (EN 60934)	AC 240 V; DC 28 V	5...25 A	
UL, CSA	AC 250 V	5...15 A	1658-G...
	AC 240 V	16 A	1658-G...
	AC 120 V	30 A	1658-G...
	AC 125 V	17...25 A	1658-G...
	DC 28 V	5...30 A	1658-G...

All dimensions without tolerances are for reference only. In the interest of improved design, performance and cost effectiveness the right to make changes in these specifications without notice is reserved. Product markings may not be exactly as the ordering codes. Errors and omissions excepted.

## Dimensions

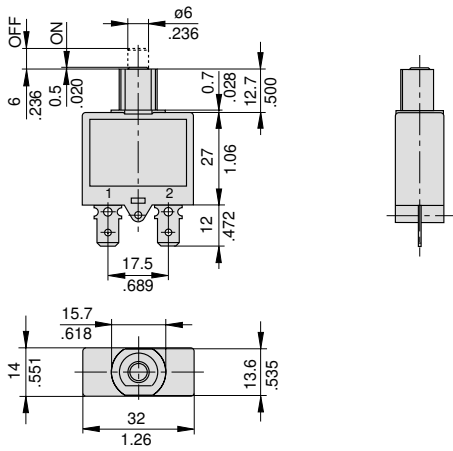

A00



A21 3/8-27UNS-2A

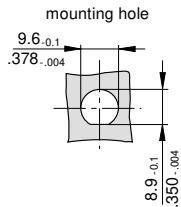
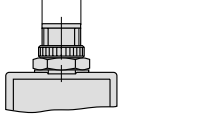

G21 3/8-27UNS-2A  
Tightening Torque= 0.8 Nm

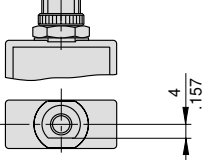

A41 10 / .394

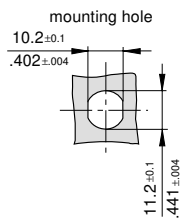
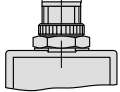

G41 10 / .394  
7/16-28UNS-2A  
Double "D"

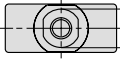

See ordering information for mounting hardware

## Installation drawing

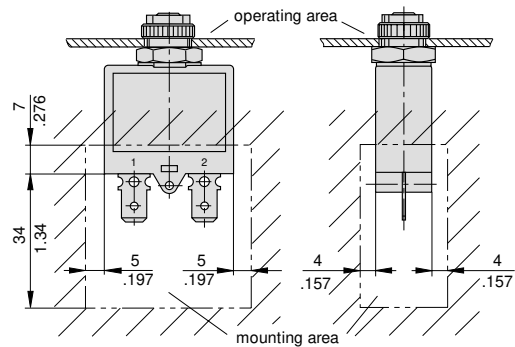

## Terminal design

P10

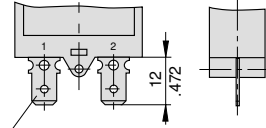

blade terminals DIN 46244-A6.3-0.8 (QC .250)

S83

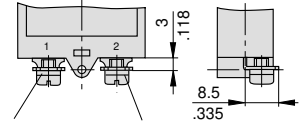

terminal screw 6-32 UNC  
lock washer

P13

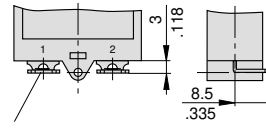

blade terminals DIN 46244-A6.3-0.8 (QC .250) angled 90°

P10-S83

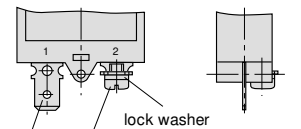

lock washer  
terminal screw 6-32 UNC

S80

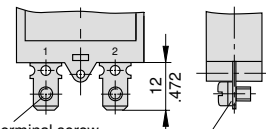

terminal screw 6-32 UNC  
lock washer

blade terminals DIN 46244-A6.3-0.8 (QC .250)

This is a metric design and millimeter dimensions take precedence ( $\frac{mm}{inch}$ )

## Internal connection diagram

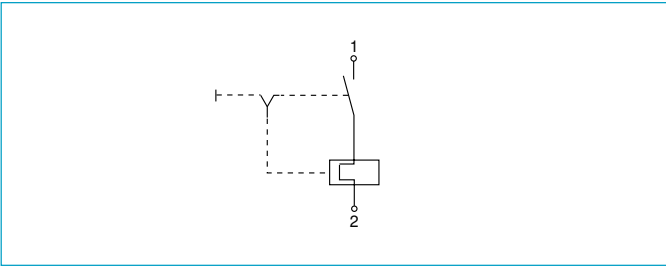

## Typical time/current characteristics

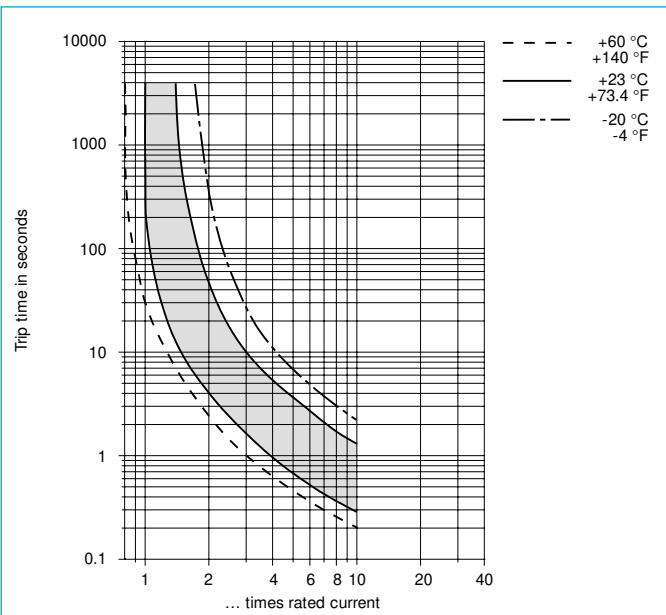

The time/current characteristic curve depends on the ambient temperature prevailing. In order to eliminate nuisance tripping, please multiply the circuit breaker current ratings by the derating factor shown below. See also section 9 – Technical information.

Ambient temperature	°F	-4	+14	+32	+73.4	+104	+122	+140
	°C	-20	-10	0	+23	+40	+50	+60
Multiplication factor		0.76	0.84	0.92	1	1.08	1.16	1.24

## Accessories

1

**Mounting nut 3/8", 27-thread**  
Y306 671 01

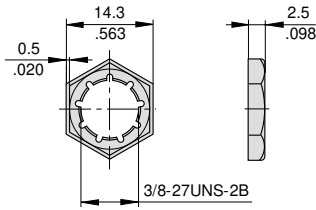

**Mounting nut 7/16", 28-thread**  
Y303 200 01

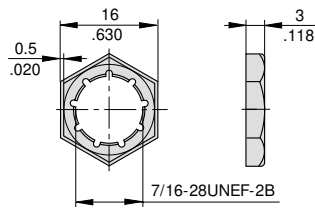

**Knurled nut 3/8", 27-thread  
nickel-plated brass**  
Y300 190 03

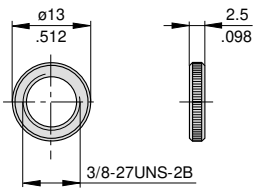

**Knurled nut 7/16", 28-thread  
nickel-plated brass**  
Y302 294 03

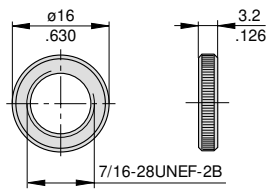

**Hex nut 3/8", 27-thread  
nickel-plated brass**  
Y300 192 01

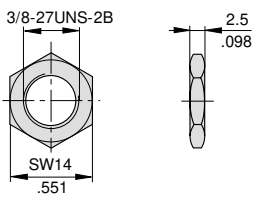

**Hex nut 7/16", 28-thread  
nickel-plated brass**  
Y302 295 01

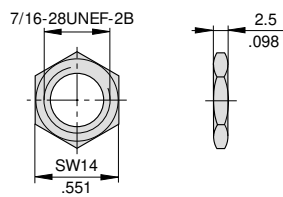

**Press to Reset Plate for 3/8",  
27-thread, aluminium**  
Y301 059 02

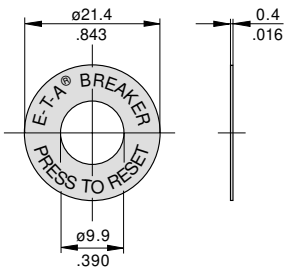

**Press to Reset Plate for 7/16",  
28-thread, aluminium**  
Y302 732 01

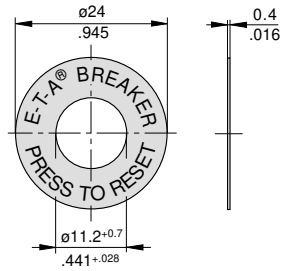

**Plastic knurled nut  
for 3/8", 27-thread**  
Y307 117 02

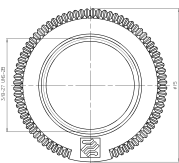

**Reset button seal for 3/8", 27-thread,  
short**  
X201 285 01

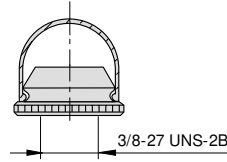

**long**  
X200 799 01

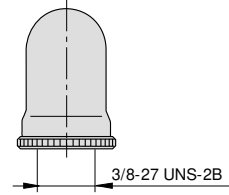

**Reset button seal for 7/16", 28-thread,  
short**  
X222 119 01

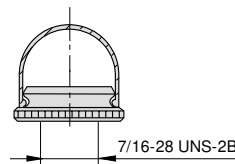

**long**  
X222 119 02

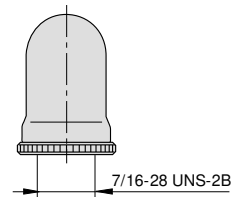

This is a metric design and millimeter dimensions take precedence ( $\frac{mm}{inch}$ )