



Chipsmall Limited consists of a professional team with an average of over 10 year of expertise in the distribution of electronic components. Based in Hongkong, we have already established firm and mutual-benefit business relationships with customers from,Europe,America and south Asia,supplying obsolete and hard-to-find components to meet their specific needs.

With the principle of “Quality Parts,Customers Priority,Honest Operation,and Considerate Service”,our business mainly focus on the distribution of electronic components. Line cards we deal with include Microchip,ALPS,ROHM,Xilinx,Pulse,ON,Everlight and Freescale. Main products comprise IC,Modules,Potentiometer,IC Socket,Relay,Connector.Our parts cover such applications as commercial,industrial, and automotives areas.

We are looking forward to setting up business relationship with you and hope to provide you with the best service and solution. Let us make a better world for our industry!



Contact us

Tel: +86-755-8981 8866 Fax: +86-755-8427 6832

Email & Skype: info@chipsmall.com Web: www.chipsmall.com

Address: A1208, Overseas Decoration Building, #122 Zhenhua RD., Futian, Shenzhen, China



CONEC[®]

TECHNOLOGY IN CONNECTORS[™]

I/O CONNECTORS



CONEC[®]

TECHNOLOGY IN CONNECTORS[™]



GERMANY

As a leading manufacturer of connectors, CONEC develops, produces and markets its products around the world to customers in the machine-tool, electronics and communications industries.

CONEC has dedicated itself to make a contribution to progress in the connector industry and to satisfy its customers through innovation, quality and excellent service. Around the world, our organization operates as a customer-oriented team.

CONEC is present in numerous countries with its own branch offices and representatives. Our local sales consultants transmit all information directly to the responsible departments to keep the paths of communication short. This provides support in the local language, quick response and competent consulting.

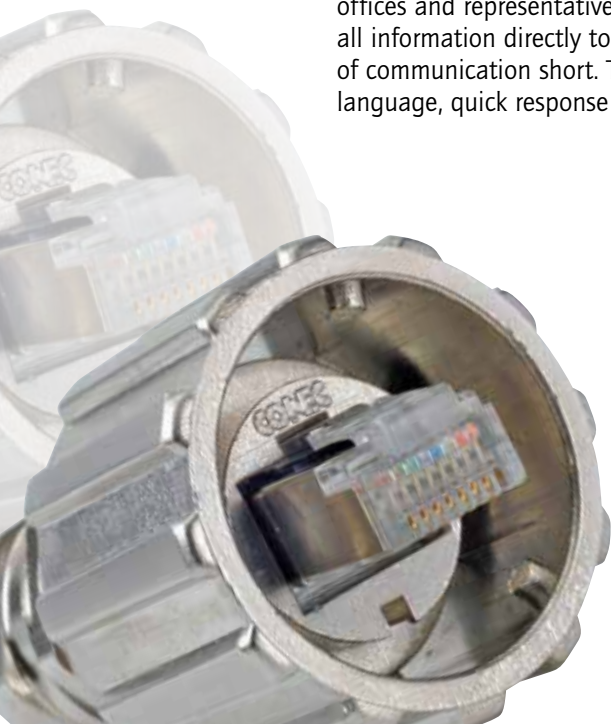



CANADA



USA

CONEC designs and manufactures a wide variety of electronic connector products. CONEC provides reliable and effective solutions to problems faced by electronic equipment manufacturers, contract manufacturers and cable assembly operations.



OUR PHILOSOPHY – CUSTOMER SATISFACTION.

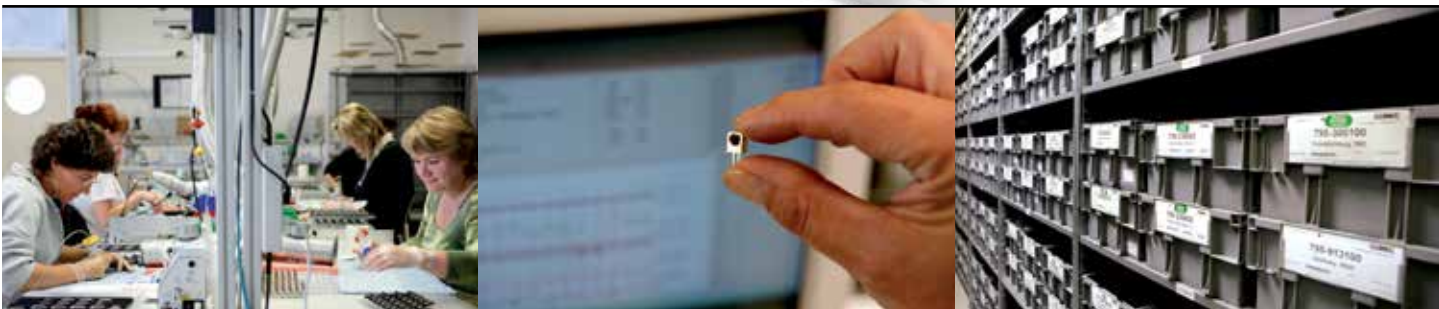

Quality is realized right from the beginning with Total Quality Management concept. Therefore our customers are included into all our processes, starting with design phase, first sampling, series production release and continuous sales support. The phases will be accompanied by drawings, samples and test reports. The entire quality process is documented and approved. CONEC is certified to ISO/TS16949:2002.



CONEC inhouse is equipped with modern test systems. We can verify the requirements and implement a continuous product improvement process to meet and exceed future requirements. To fulfill international and national requirements most of CONEC product series are registered by UL, CSA or VDE



CONEC IS YOUR SPECIALIST FOR DESIGN AND PRODUCTION OF SPECIAL CUSTOMIZED PRODUCTS.

Flexibility, quality assurance and rapid response are required in today's market more than ever before. CONEC fulfills these demands with central order-processing and well implemented quality control systems. Statistical process control as well as just in time deliveries are a common practice. Numerous customers honored this performance by approving CONEC to a "Preferred Supplier" status.



Are you looking for application-specific solutions?
Standard products do not meet your needs?
The implementation deadline is tight?







CONEC experienced design team can create your solution for you:









- Special Interconnect solutions to customers specifications
- Prototypes and small series production batches
- Connectors with increased IP ratings for harsh environments.

Contact us to discuss your special requirements.



TABLE OF CONTENTS

SECTION 1	D-SUB CONNECTORS	 1 2 1 24 1 32 1 44 1 48
SECTION 2	COMBINATION D-SUB CONNECTORS	 2 2 2 10 2 26 2 30 2 36 2 38 2 54
SECTION 3	FILTER D-SUB CONNECTORS	 3 2 3 4 3 30 3 34 3 40 3 50 3 52 3 62 3 64
SECTION 4	C-FILTER COMBINATION D-SUB CONNECTORS	 4 2 4 5 4 10 4 20 4 25
SECTION 5	MICROTCA POWER MODUL CONNECTORS	 5 2 5 4 5 10 5 14 5 16
SECTION 6	RJ45 MODULAR JACK WITH MAGNETIC FILTER	 6 2 6 4 6 16
SECTION 7	D-SUB HOODS AND ACCESSORIES	 7 2 7 13 7 34 7 36 7 39 7 48

SECTION 8	IP67 D-SUB CONNECTORS	 8 2 8 4 8 11 8 16 8 20 8 25
SECTION 9	IP67 COMBINATION D-SUB CONNECTORS	 9 2 9 8 9 23 9 29 9 32
SECTION 10	IP67-FILTER D-SUB CONNECTORS	 10 2 10 4 10 18 10 22
SECTION 11	RJ45-IP67 INDUSTRIAL ETHERNET CONNECTOR SYSTEM	 11 2 11 3 11 14 11 18 11 26
SECTION 12	USB 2.0-IP67 CONNECTOR SYSTEM	 12 2 12 3 12 5 12 10 12 12
SECTION 13	FIBER OPTIC CONNECTORS	 13 2 13 5 13 8
SECTION 14	INSTALLATION AND ASSEMBLY TOOLS	 14 2
SEKTION 15	PART NUMBERS	 15 2

SECTION 1

D-SUBMINIATURE CONNECTORS

CONEC D-Subminiature connector dimensions conform to IEC 60807-2 (formerly DIN 41652) or MIL-C-24308. These cable/device connectors each consist of a plug/jack mating pair which meets IEC Recommendation 48 B, deliverable in five standardized housing sizes with standard pole counts of 9, 15, 25, 37 and 50. In addition to this, we also have a high density series deliverable with pole counts of 15, 26, 44, 62 and 78.

These connectors are utilized in control, regulation and communications technology. The machined, precision contacts are hard-gold plated over a nickel barrier layer appropriate to the given application requirements.

The isolating body is made of polyester GF, self-extinguishing per UL 94 V0, and can also be adapted on an application-specific basis.





The trapezoid shaped housing (shell) provides mechanical protection, electrical shielding and ensures proper plug-in alignment. CONEC connectors are compatible with industry standards. Hoods and Backshells are configured for either straight or side cable entry.

An extensive assortment consisting of protective caps, hard ware and latches can be supplied.

Need a custom design? Please contact us.

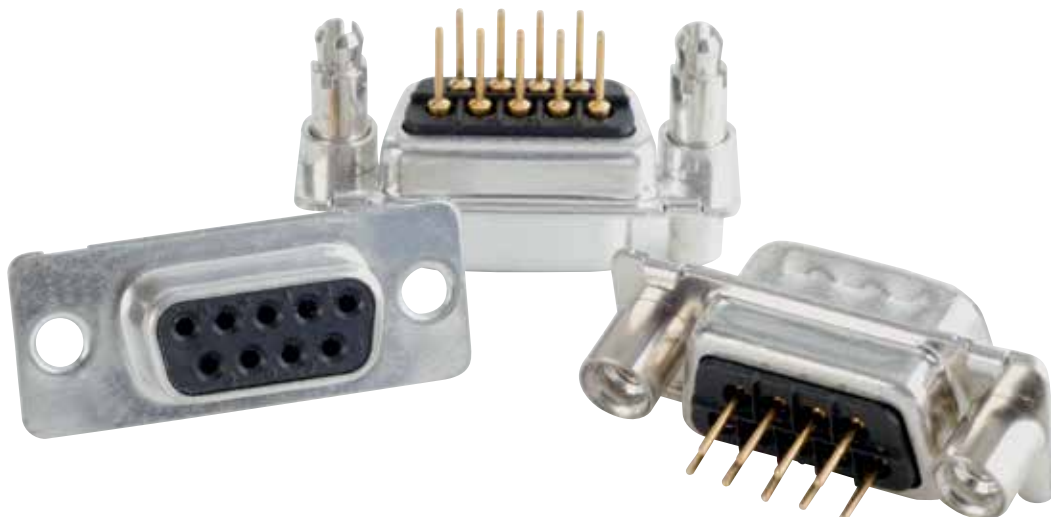

D-SUB STANDARD

Solder cup – Precision machined contacts – For wire size AWG 20



RoHS compliant – CSA listed, File No.: LR 115000-1 – UL listed, File No.: E202784

DESCRIPTION

- Suitable for wire size AWG 20
- Mounting styles:
 - with through-hole, $\varnothing .118''/3 \text{ mm}$
 - with M3 or 4-40 UNC threaded insert
- Quality class 3 (also available in quality class 1)
- Shell: Steel tin plated (brass tin plated or stainless steel available on request)

SOCKET CONNECTOR

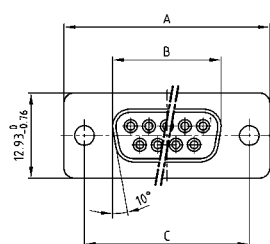

No. of pos.	A -0.76	B -0.25	C
09	31.19	16.46	25.00 $+0.12$
15	39.52	24.79	33.30 $+0.15$ -0.10
25	53.42	38.50	47.04 $+0.13$
37	69.70	54.96	63.50 $+0.13$
50	67.31	52.55	61.10 $+0.14$ -0.11

Mounting style: Through-hole

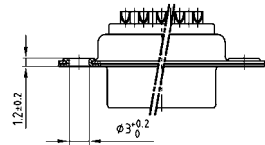

Mounting style: Threaded insert

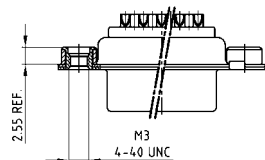

PLUG CONNECTOR

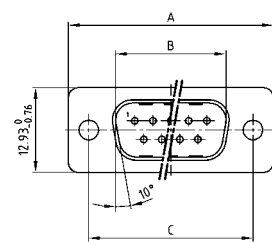

No. of pos.	A -0.76	B +0.25	C	D -0.3
09	31.19	16.79	25.00 $+0.12$	6.12
15	39.52	25.12	33.30 $+0.15$ -0.10	6.12
25	53.42	38.84	47.04 $+0.13$	5.99
37	69.70	55.30	63.50 $+0.13$	5.99
50	67.31	52.68	61.10 $+0.14$ -0.11	5.99

Mounting style: Through-hole

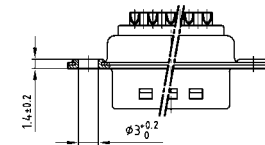

Mounting style: Threaded insert

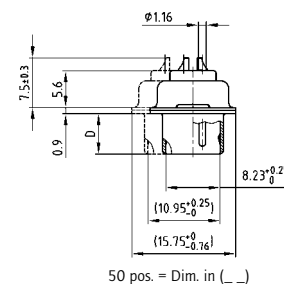
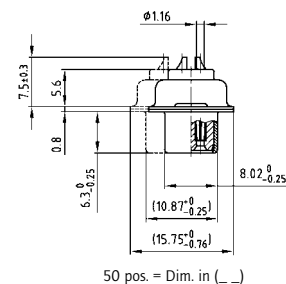
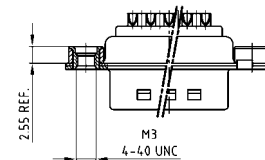

ORDER DATA

SOCKET CONNECTOR		
No. of pos.	Mounting style	Part Number
09	Through-hole	164A10019X
15	Through-hole	164A10029X
25	Through-hole	164A10039X
37	Through-hole	164A10049X
50	Through-hole	164A10059X
09	4-40 UNC Threaded insert	164A10219X
15	4-40 UNC Threaded insert	164A10229X
25	4-40 UNC Threaded insert	164A10239X
37	4-40 UNC Threaded insert	164A10249X
50	4-40 UNC Threaded insert	164A10259X
09	M3 Threaded insert	164A10269X
15	M3 Threaded insert	164A10279X
25	M3 Threaded insert	164A10289X
37	M3 Threaded insert	164A10299X
50	M3 Threaded insert	164A10309X

PLUG CONNECTOR		
No. of pos.	Mounting style	Part Number
09	Through-hole	163A11069X
15	Through-hole	163A11079X
25	Through-hole	163A11089X
37	Through-hole	163A11099X
50	Through-hole	163A11109X
09	4-40 UNC Threaded insert	163A11269X
15	4-40 UNC Threaded insert	163A11279X
25	4-40 UNC Threaded insert	163A11289X
37	4-40 UNC Threaded insert	163A11299X
50	4-40 UNC Threaded insert	163A11309X
09	M3 Threaded insert	163A11319X
15	M3 Threaded insert	163A11329X
25	M3 Threaded insert	163A11339X
37	M3 Threaded insert	163A11349X
50	M3 Threaded insert	163A11359X

D-SUB STANDARD

Solder cup – Stamped contacts – For wire size AWG 20



RoHS compliant – CSA listed, File No.: LR 115000-1 – UL listed, File No.: E202784

DESCRIPTION

- Suitable for wire size AWG 20
- Mounting style: with through-hole, Ø .118" / 3 mm
- Quality class 3 (other quality classes on request)
- Shell: Steel tin plated

SOCKET CONNECTOR

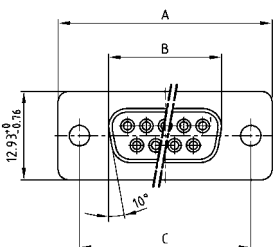

No. of pos.	A -0.76	B -0.25	C
09	31.19	16.46	25.00 +0.12
15	39.52	24.79	33.30 +0.15 -0.10
25	53.42	38.50	47.04 ±0.13
37	69.70	54.96	63.50 ±0.13
50	67.31	52.55	61.10 +0.14 -0.11

Mounting style: Through-hole

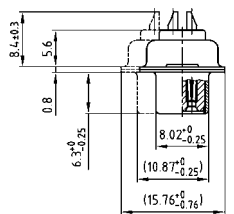
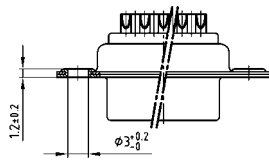

50 pos. = Dim. in (_)

PLUG CONNECTOR

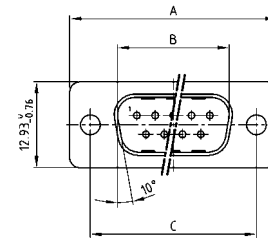

No. of pos.	A -0.76	B -0.25	C	D -0.3
09	31.19	16.79	25.00 -0.12	6.12
15	39.52	25.12	33.30 +0.15 -0.10	6.12
25	53.42	38.84	47.04 ±0.13	5.99
37	69.70	55.30	63.50 ±0.13	5.99
50	67.31	52.68	61.10 -0.14 -0.11	5.99

Mounting style: Through-hole

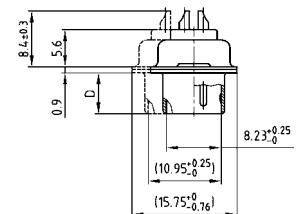
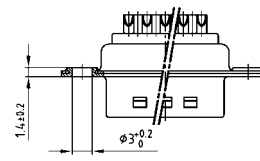

50 pos. = Dim. in (_)

ORDER DATA

SOCKET CONNECTOR		
No. of pos.	Mounting style	Part Number
09	Through-hole	302A10019X
15	Through-hole	302A10029X
25	Through-hole	302A10059X
37	Through-hole	302A10069X
50	Through-hole	302A10079X

PLUG CONNECTOR		
No. of pos.	Mounting style	Part Number
09	Through-hole	301A10019X
15	Through-hole	301A10029X
25	Through-hole	301A10059X
37	Through-hole	301A10069X
50	Through-hole	301A10079X

D-SUB STANDARD

Solder pin – Straight – Precision machined contacts



RoHS compliant – CSA listed, File No.: LR 115000-1 – UL listed, File No.: E202784

SOCKET CONNECTOR

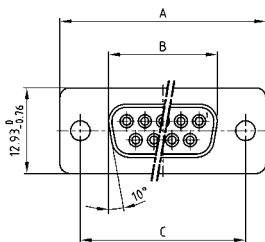

No. of pos.	A -0.76	B -0.25	C
09	31.19	16.46	25.00 +0.12
15	39.52	24.79	33.30 +0.15 / -0.10
25	53.42	38.50	47.04 +0.13
37	69.70	54.96	63.50 +0.13
50	67.31	52.55	61.10 +0.14 / -0.11

PCB-Layout: Kat1kFUA

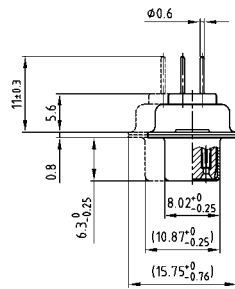
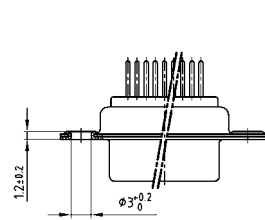

50 pos. = Dim. in (_)

DESCRIPTION

- Mounting styles:
 - with through-hole, Ø .118"/3 mm
 - with 4-40 UNC or M3 threaded insert
 - with 4-40 UNC or M3 threaded rear spacer
 - with 4-40 UNC or M3 front and threaded rear spacer
 - with 4-40 UNC front/M3 threaded rear spacer
 - with M3 front/4-40 UNC or M3 threaded rear spacer with PCB clip
 - with 4-40 UNC or M3 Front/Threaded rear spacer with PCB clip
- Quality class 3 (also available in quality class 1)
- Shell: Steel tin plated (brass tin plated or stainless steel available on request)

PLUG CONNECTOR

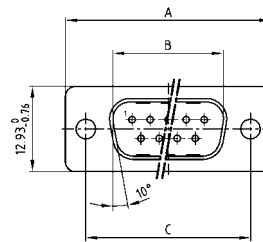

No. of pos.	A -0.76	B -0.25	C	D -0.3
09	31.19	16.79	25.00 +0.12	6.12
15	39.52	25.12	33.30 +0.15 / -0.10	6.12
25	53.42	38.84	47.04 +0.13	5.99
37	69.70	55.30	63.50 +0.13	5.99
50	67.31	52.68	61.10 +0.14 / -0.11	5.99

PCB-Layout: Kat1kFUA

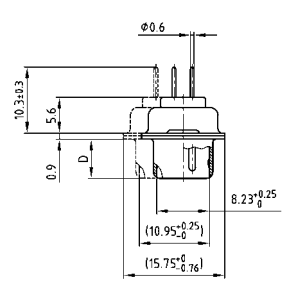
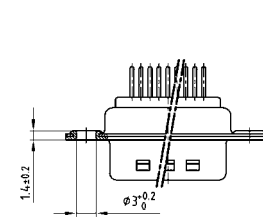

50 pos. = Dim. in (_)

ORDER DATA

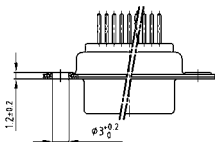

SOCKET CONNECTOR		
No. of pos.	Mounting style	Part Number
09	Through-hole	164A10069X
15	Through-hole	164A10079X
25	Through-hole	164A10089X
37	Through-hole	164A10099X
50	Through-hole	164A10109X

PLUG CONNECTOR		
No. of pos.	Mounting style	Part Number
09	Through-hole	163A11119X
15	Through-hole	163A11129X
25	Through-hole	163A11139X
37	Through-hole	163A11149X
50	Through-hole	163A11159X

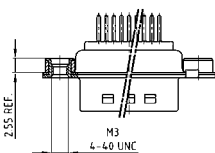

SOCKET CONNECTOR		
No. of pos.	Mounting style	Part Number
09	4-40 UNC Threaded insert	164A10319X
15	4-40 UNC Threaded insert	164A10329X
25	4-40 UNC Threaded insert	164A10339X
37	4-40 UNC Threaded insert	164A10349X
50	4-40 UNC Threaded insert	164A10359X
09	M3 Threaded insert	164A10369X
15	M3 Threaded insert	164A10379X
25	M3 Threaded insert	164A10389X
37	M3 Threaded insert	164A10399X
50	M3 Threaded insert	164A10409X

PLUG CONNECTOR		
No. of pos.	Mounting style	Part Number
09	4-40 UNC Threaded insert	163A11369X
15	4-40 UNC Threaded insert	163A11379X
25	4-40 UNC Threaded insert	163A11389X
37	4-40 UNC Threaded insert	163A11399X
50	4-40 UNC Threaded insert	163A11409X
09	M3 Threaded insert	163A11419X
15	M3 Threaded insert	163A11429X
25	M3 Threaded insert	163A11439X
37	M3 Threaded insert	163A11449X
50	M3 Threaded insert	163A11459X

D-SUB STANDARD – MOUNTING STYLES

Solder pin – Straight – Precision machined contacts

ORDER DATA

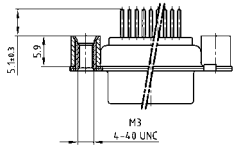

SOCKET CONNECTOR		
No. of pos.	Mounting style	Part Number
09	4-40 UNC Threaded rear spacer	164A12029X
15	4-40 UNC Threaded rear spacer	164A12039X
25	4-40 UNC Threaded rear spacer	164A12049X
37	4-40 UNC Threaded rear spacer	164A12059X
50	4-40 UNC Threaded rear spacer	164A12069X
09	M3 Threaded rear spacer	164A12079X
15	M3 Threaded rear spacer	164A12089X
25	M3 Threaded rear spacer	164A12099X
37	M3 Threaded rear spacer	164A12109X
50	M3 Threaded rear spacer	164A12119X

PLUG CONNECTOR		
No. of pos.	Mounting style	Part Number
09	4-40 UNC Threaded rear spacer	163A13629X
15	4-40 UNC Threaded rear spacer	163A13639X
25	4-40 UNC Threaded rear spacer	163A13649X
37	4-40 UNC Threaded rear spacer	163A13659X
50	4-40 UNC Threaded rear spacer	163A13669X
09	M3 Threaded rear spacer	163A13679X
15	M3 Threaded rear spacer	163A13689X
25	M3 Threaded rear spacer	163A13699X
37	M3 Threaded rear spacer	163A13709X
50	M3 Threaded rear spacer	163A13719X

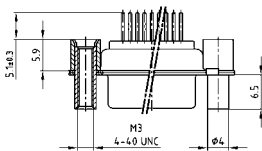

SOCKET CONNECTOR		
No. of pos.	Mounting style	Part Number
09	4-40 UNC Front/Threaded rear spacer	164A12129X
15	4-40 UNC Front/Threaded rear spacer	164A12139X
25	4-40 UNC Front/Threaded rear spacer	164A12149X
37	4-40 UNC Front/Threaded rear spacer	164A12159X
50	4-40 UNC Front/Threaded rear spacer	164A12169X
09	M3 Front/Threaded rear spacer	164A12179X
15	M3 Front/Threaded rear spacer	164A12189X
25	M3 Front/Threaded rear spacer	164A12199X
37	M3 Front/Threaded rear spacer	164A12209X
50	M3 Front/Threaded rear spacer	164A12219X

PLUG CONNECTOR		
No. of pos.	Mounting style	Part Number
09	4-40 UNC Front/Threaded rear spacer	163A13729X
15	4-40 UNC Front/Threaded rear spacer	163A13739X
25	4-40 UNC Front/Threaded rear spacer	163A13749X
37	4-40 UNC Front/Threaded rear spacer	163A13759X
50	4-40 UNC Front/Threaded rear spacer	163A13769X
09	M3 Front/Threaded rear spacer	163A13779X
15	M3 Front/Threaded rear spacer	163A13789X
25	M3 Front/Threaded rear spacer	163A13799X
37	M3 Front/Threaded rear spacer	163A13809X
50	M3 Front/Threaded rear spacer	163A13819X

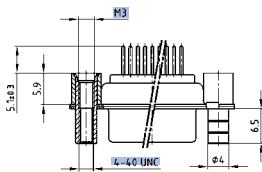

SOCKET CONNECTOR		
No. of pos.	Mounting style	Part Number
09	4-40 UNC Front /M3 Threaded rear spacer	164A12919X
15	4-40 UNC Front /M3 Threaded rear spacer	164A12929X
25	4-40 UNC Front /M3 Threaded rear spacer	164A12939X
37	4-40 UNC Front /M3 Threaded rear spacer	164A12949X
50	4-40 UNC Front /M3 Threaded rear spacer	164A12959X

PLUG CONNECTOR		
No. of pos.	Mounting style	Part Number
09	4-40 UNC Front /M3 Threaded rear spacer	163A14439X
15	4-40 UNC Front /M3 Threaded rear spacer	163A14449X
25	4-40 UNC Front /M3 Threaded rear spacer	163A14459X
37	4-40 UNC Front /M3 Threaded rear spacer	163A14469X
50	4-40 UNC Front /M3 Threaded rear spacer	163A14479X

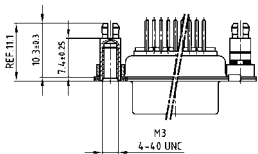

SOCKET CONNECTOR		
No. of pos.	Mounting style	Part Number
09	4-40 UNC Threaded rear spacer PCB clip	164A16569X
15	4-40 UNC Threaded rear spacer PCB clip	164A16579X
25	4-40 UNC Threaded rear spacer PCB clip	164A16589X
37	4-40 UNC Threaded rear spacer PCB clip	164A16599X
50	4-40 UNC Threaded rear spacer PCB clip	164A16609X
09	M3 Threaded rear spacer PCB clip	164A16619X
15	M3 Threaded rear spacer PCB clip	164A16629X
25	M3 Threaded rear spacer PCB clip	164A16639X
37	M3 Threaded rear spacer PCB clip	164A16649X
50	M3 Threaded rear spacer PCB clip	164A16659X

PLUG CONNECTOR		
No. of pos.	Mounting style	Part Number
09	4-40 UNC Threaded rear spacer PCB clip	163A16159X
15	4-40 UNC Threaded rear spacer PCB clip	163A16169X
25	4-40 UNC Threaded rear spacer PCB clip	163A16179X
37	4-40 UNC Threaded rear spacer PCB clip	163A16189X
50	4-40 UNC Threaded rear spacer PCB clip	163A16199X
09	M3 Threaded rear spacer PCB clip	163A16209X
15	M3 Threaded rear spacer PCB clip	163A16219X
25	M3 Threaded rear spacer PCB clip	163A16229X
37	M3 Threaded rear spacer PCB clip	163A16239X
50	M3 Threaded rear spacer PCB clip	163A16249X

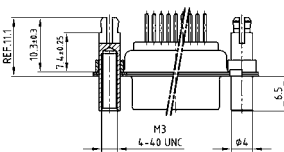

SOCKET CONNECTOR		
No. of pos.	Mounting style	Part Number
09	4-40 UNC Front/Threaded rear spacer PCB clip	164A16669X
15	4-40 UNC Front/Threaded rear spacer PCB clip	164A16679X
25	4-40 UNC Front/Threaded rear spacer PCB clip	164A16689X
37	4-40 UNC Front/Threaded rear spacer PCB clip	164A16699X
50	4-40 UNC Front/Threaded rear spacer PCB clip	164A16709X
09	M3 Front/Threaded rear spacer PCB clip	164A16719X
15	M3 Front/Threaded rear spacer PCB clip	164A16729X
25	M3 Front/Threaded rear spacer PCB clip	164A16739X
37	M3 Front/Threaded rear spacer PCB clip	164A16749X
50	M3 Front/Threaded rear spacer PCB clip	164A16759X

PLUG CONNECTOR		
No. of pos.	Mounting style	Part Number
09	4-40 UNC Front/Threaded rear spacer PCB clip	163A16259X
15	4-40 UNC Front/Threaded rear spacer PCB clip	163A16269X
25	4-40 UNC Front/Threaded rear spacer PCB clip	163A16279X
37	4-40 UNC Front/Threaded rear spacer PCB clip	163A16289X
50	4-40 UNC Front/Threaded rear spacer PCB clip	163A16299X
09	M3 Front/Threaded rear spacer PCB clip	163A16309X
15	M3 Front/Threaded rear spacer PCB clip	163A16319X
25	M3 Front/Threaded rear spacer PCB clip	163A16329X
37	M3 Front/Threaded rear spacer PCB clip	163A16339X
50	M3 Front/Threaded rear spacer PCB clip	163A16349X

PCB clip for .126"/3.2 ± .004"/0.10 mm hole diameter and .063"/1.6 mm circuit board thickness.

PCB-Layout: Kat1kFUA

PCB-Layout: Kat1kFUA

D-SUB STANDARD

Solder pin – Straight – Stamped contacts



RoHS compliant – CSA listed, File No.: LR 115000-1 – UL listed, File No.: E202784

SOCKET CONNECTOR

9-37 pos.

No. of pos.	A	B	C	D
09	30.80	16.30	25.00	19.20
15	39.20	24.60	33.30	27.70
25	53.10	38.30	47.04	41.10
37	69.40	54.80	63.50	57.30

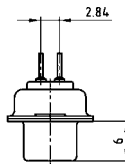
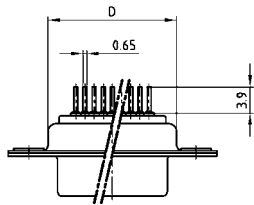
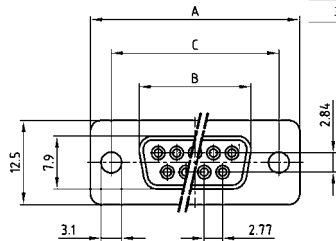

DESCRIPTION

- Mounting styles:
 - with through-hole, \varnothing .118" / 3 mm
 - with 4-40 UNC threaded insert
 - with 4-40 UNC threaded rear spacer
 - with 4-40 UNC threaded rear spacer with PCB clip
 - with 4-40 UNC front and threaded rear spacer with PCB clip
- Quality class 3 (other quality classes on request)
- Shell: Steel tin plated

PLUG CONNECTOR

9-37 pos.

No. of pos.	A	B	C	D
09	30.80	16.92	25.00	19.20
15	39.20	25.25	33.30	27.70
25	53.10	38.96	47.04	41.10
37	69.40	55.42	63.50	57.30

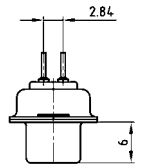
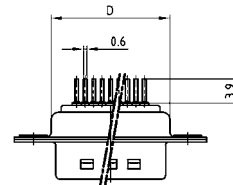
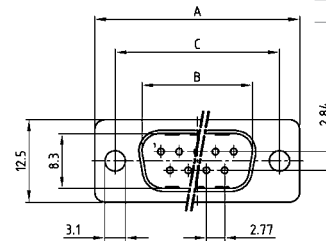

50 pos.

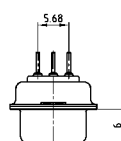
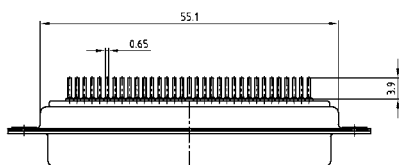
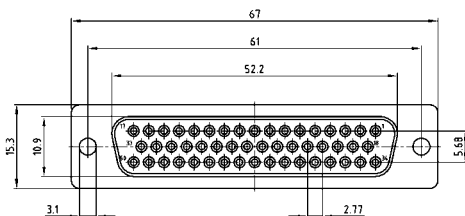

50 pos.

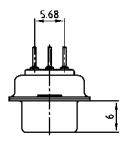
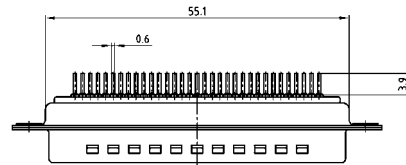
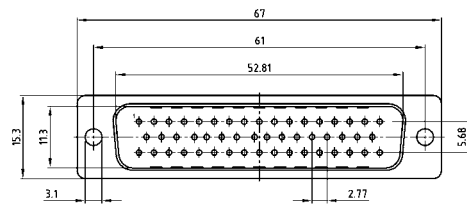

D-SUB STANDARD – MOUNTING STYLES

Solder pin – Straight – Stamped contacts

ORDER DATA

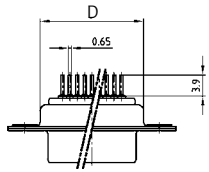

SOCKET CONNECTOR		
No. of pos.	Mounting style	Part Number
09	Through-hole	DLS1XS4AD01X
15	Through-hole	DLS2XS4AD01X
25	Through-hole	DLS3XS4AD01X
37	Through-hole	DLS4XS4AD01X
50	Through-hole	DLS5XS4AD01X

PLUG CONNECTOR		
No. of pos.	Mounting style	Part Number
09	Through-hole	DLS1XP4AD01X
15	Through-hole	DLS2XP4AD01X
25	Through-hole	DLS3XP4AD01X
37	Through-hole	DLS4XP4AD01X
50	Through-hole	DLS5XP4AD01X

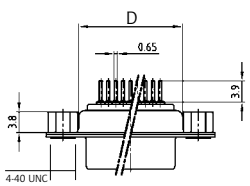

SOCKET CONNECTOR		
No. of pos.	Mounting style 4-40 UNC	Part Number
09	Threaded insert	DLS1XS4AG06X
15	Threaded insert	DLS2XS4AG06X
25	Threaded insert	DLS3XS4AG06X
37	Threaded insert	DLS4XS4AG06X
50	Threaded insert	DLS5XS4AG06X

PLUG CONNECTOR		
No. of pos.	Mounting style 4-40 UNC	Part Number
09	Threaded insert	DLS1XP4AG06X
15	Threaded insert	DLS2XP4AG06X
25	Threaded insert	DLS3XP4AG06X
37	Threaded insert	DLS4XP4AG06X
50	Threaded insert	DLS5XP4AG06X

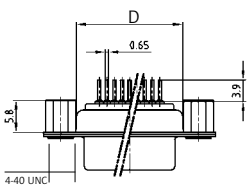

SOCKET CONNECTOR		
No. of pos.	Mounting style 4-40 UNC	Part Number
09	Threaded rear spacer	DLS1XS4AA37X
15	Threaded rear spacer	DLS2XS4AA37X
25	Threaded rear spacer	DLS3XS4AA37X
37	Threaded rear spacer	DLS4XS4AA37X
50	Threaded rear spacer	DLS5XS4AA37X

PLUG CONNECTOR		
No. of pos.	Mounting style 4-40 UNC	Part Number
09	Threaded rear spacer	DLS1XP4AA37X
15	Threaded rear spacer	DLS2XP4AA37X
25	Threaded rear spacer	DLS3XP4AA37X
37	Threaded rear spacer	DLS4XP4AA37X
50	Threaded rear spacer	DLS5XP4AA37X

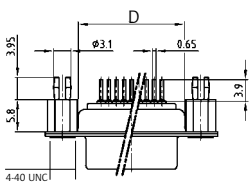

SOCKET CONNECTOR		
No. of pos.	Mounting style 4-40 UNC	Part Number
09	Threaded rear spacer PCB clip	DLS1XS4AA35X
15	Threaded rear spacer PCB clip	DLS2XS4AA35X
25	Threaded rear spacer PCB clip	DLS3XS4AA35X
37	Threaded rear spacer PCB clip	DLS4XS4AA35X
50	Threaded rear spacer PCB clip	DLS5XS4AA35X

PLUG CONNECTOR		
No. of pos.	Mounting style 4-40 UNC	Part Number
09	Threaded rear spacer PCB clip	DLS1XP4AA35X
15	Threaded rear spacer PCB clip	DLS2XP4AA35X
25	Threaded rear spacer PCB clip	DLS3XP4AA35X
37	Threaded rear spacer PCB clip	DLS4XP4AA35X
50	Threaded rear spacer PCB clip	DLS5XP4AA35X

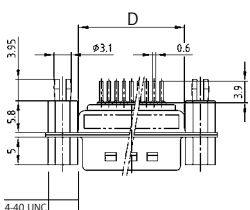

SOCKET CONNECTOR		
No. of pos.	Mounting style 4-40 UNC	Part Number
09	Front/Threaded rear spacer PCB clip	DLS1XS4AA39X
15	Front/Threaded rear spacer PCB clip	DLS2XS4AA39X
25	Front/Threaded rear spacer PCB clip	DLS3XS4AA39X
37	Front/Threaded rear spacer PCB clip	DLS4XS4AA39X
50	Front/Threaded rear spacer PCB clip	DLS5XS4AA39X

PLUG CONNECTOR		
No. of pos.	Mounting style 4-40 UNC	Part Number
09	Front/Threaded rear spacer PCB clip	DLS1XP4AA39X
15	Front/Threaded rear spacer PCB clip	DLS2XP4AA39X
25	Front/Threaded rear spacer PCB clip	DLS3XP4AA39X
37	Front/Threaded rear spacer PCB clip	DLS4XP4AA39X
50	Front/Threaded rear spacer PCB clip	DLS5XP4AA39X

PCB clip for .126"/3.2 ± .004"/0.10 mm hole diameter and .063"/1.6 mm circuit board thickness.

D-SUB STANDARD

Press-fit contact – Straight – Precision machined contacts

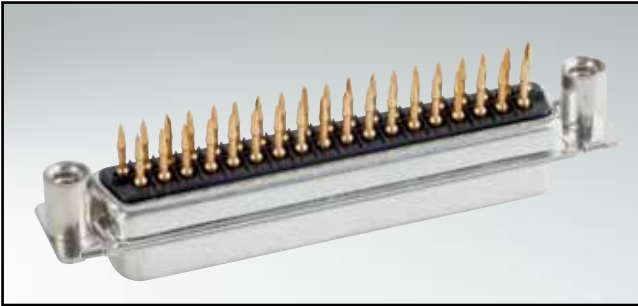

RoHS compliant – CSA listed, File No.: LR 115000-1 – UL listed, File No.: E202784

SOCKET CONNECTOR

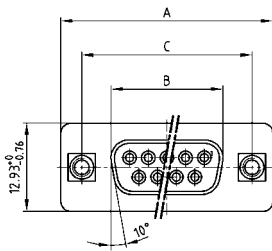

No. of pos.	A -0.76	B -0.25	C
09	31.19	16.46	25.00 ±0.12
15	39.52	24.79	33.30 ±0.15 ±0.10
25	53.42	38.50	47.04 ±0.13
37	69.70	54.96	63.50 ±0.13

9-37 pos.

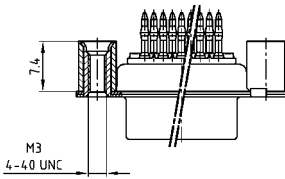

50 pos.

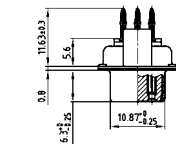
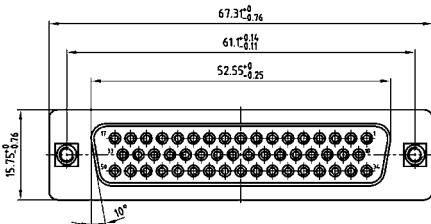
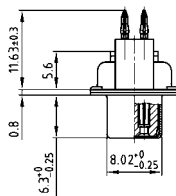

DESCRIPTION

- Mounting style: with M3 or 4-40 UNC threaded rear spacer
- For .040" / 1.0 mm ± $\frac{0.003}{.002}$ / $\frac{0.09}{0.06}$ mm finished through-hole diameter Refer to product drawing for details
- Quality class 3 (also available in quality class 1)
- Shell: Steel tin plated (brass tin plated or stainless steel available on request)
- Order press-fit tool separately

PLUG CONNECTOR

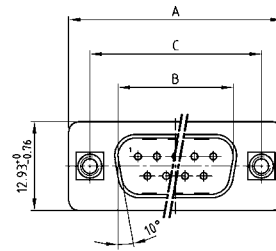

No. of pos.	A -0.76	B +0.25	C	D -0.3
09	31.19	16.79	25.00 ±0.12	6.12
15	39.52	25.12	33.30 ±0.15 ±0.10	6.12
25	53.42	38.84	47.04 ±0.13	5.99
37	69.70	55.30	63.50 ±0.13	5.99

9-37 pos.

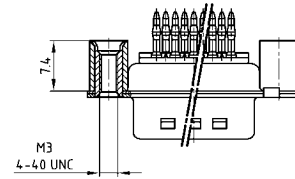

50 pos.

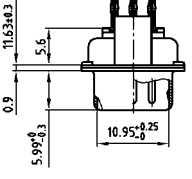
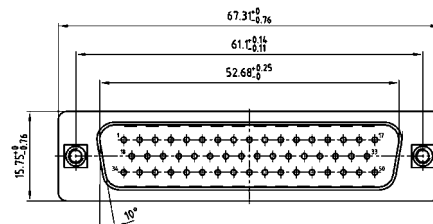
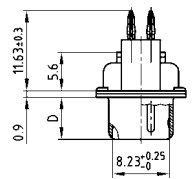

ORDER DATA

SOCKET CONNECTOR		
No. of pos.	Mounting style	Part Number
09	4-40 UNC Threaded rear spacer	DSS1XSFAA49X
15	4-40 UNC Threaded rear spacer	DSS2XSFAA49X
25	4-40 UNC Threaded rear spacer	DSS3XSFAA49X
37	4-40 UNC Threaded rear spacer	DSS4XSFAA49X
50	4-40 UNC Threaded rear spacer	DSS5XSFAA49X
09	M3 Threaded rear spacer	DSS1XSFAA50X
15	M3 Threaded rear spacer	DSS2XSFAA50X
25	M3 Threaded rear spacer	DSS3XSFAA50X
37	M3 Threaded rear spacer	DSS4XSFAA50X
50	M3 Threaded rear spacer	DSS5XSFAA50X

PLUG CONNECTOR		
No. of pos.	Mounting style	Part Number
09	4-40 UNC Threaded rear spacer	DSS1XPFAA49X
15	4-40 UNC Threaded rear spacer	DSS2XPFAA49X
25	4-40 UNC Threaded rear spacer	DSS3XPFAA49X
37	4-40 UNC Threaded rear spacer	DSS4XPFAA49X
50	4-40 UNC Threaded rear spacer	DSS5XPFAA49X
09	M3 Threaded rear spacer	DSS1XPFAA50X
15	M3 Threaded rear spacer	DSS2XPFAA50X
25	M3 Threaded rear spacer	DSS3XPFAA50X
37	M3 Threaded rear spacer	DSS4XPFAA50X
50	M3 Threaded rear spacer	DSS5XPFAA50X

D-SUB STANDARD

Press-fit contact – Straight – Precision machined contacts – Rear press-fit spacer



RoHS compliant – CSA listed, File No.: LR 115000-1 – UL listed, File No.: E202784

SOCKET CONNECTOR

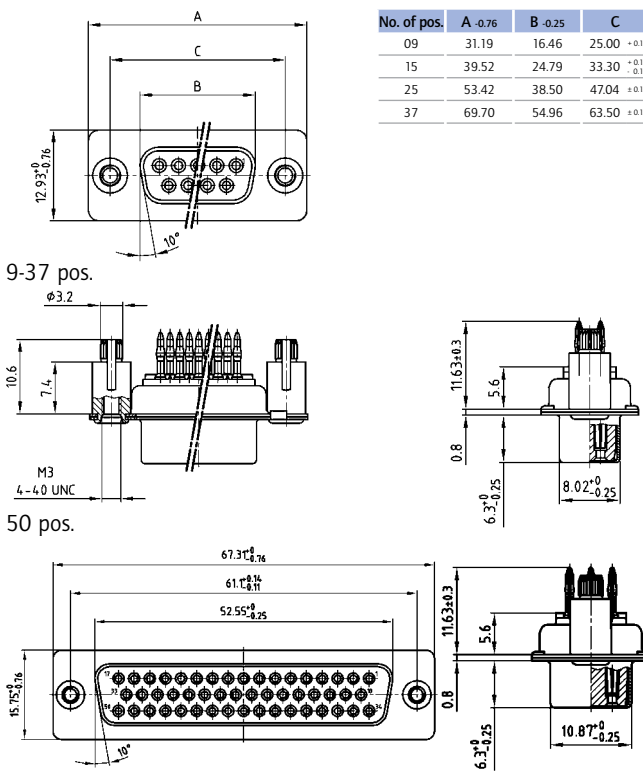

DESCRIPTION

- Mounting style:
with M3 or 4-40 UNC rear press-fit spacer
- For .040" / 1.0 mm ± $\frac{0.003}{.002} / \frac{0.09}{0.06}$ mm finished through-hole diameter
Refer to product drawing for details
- Quality class 3 (also available in quality class 1)
- Shell: Steel tin plated (brass tin plated or stainless steel available on request)
- Order press-fit tool separately

PLUG CONNECTOR

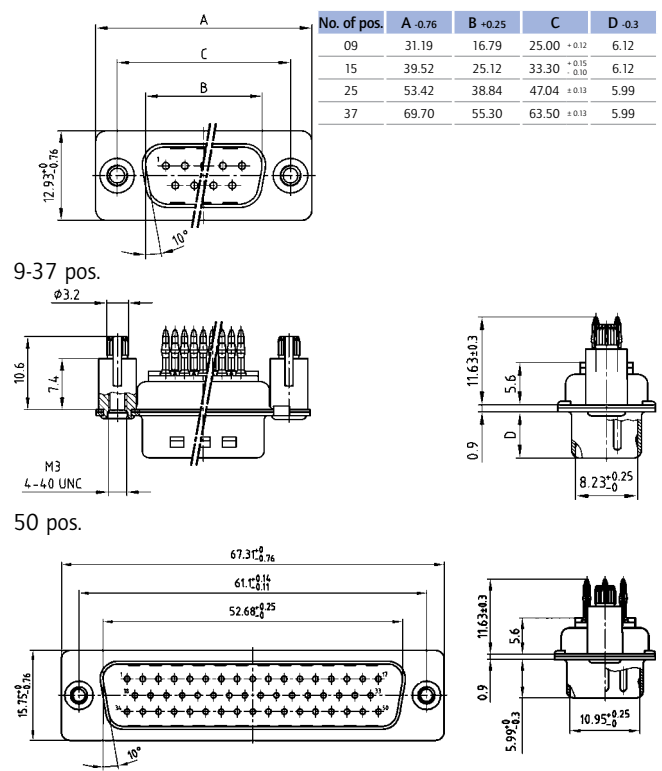

ORDER DATA

SOCKET CONNECTOR		
No. of pos.	Mounting style	Part Number
09	4-40 UNC Rear press-fit spacer	DSS1XSFAA54X
15	4-40 UNC Rear press-fit spacer	DSS2XSFAA54X
25	4-40 UNC Rear press-fit spacer	DSS3XSFAA54X
37	4-40 UNC Rear press-fit spacer	DSS4XSFAA54X
50	4-40 UNC Rear press-fit spacer	DSS5XSFAA54X
09	M3 Rear press-fit spacer	DSS1XPFAA53X
15	M3 Rear press-fit spacer	DSS2XPFAA53X
25	M3 Rear press-fit spacer	DSS3XPFAA53X
37	M3 Rear press-fit spacer	DSS4XPFAA53X
50	M3 Rear press-fit spacer	DSS5XPFAA53X

PLUG CONNECTOR		
No. of pos.	Mounting style	Part Number
09	4-40 UNC Rear press-fit spacer	DSS1XPFAA54X
15	4-40 UNC Rear press-fit spacer	DSS2XPFAA54X
25	4-40 UNC Rear press-fit spacer	DSS3XPFAA54X
37	4-40 UNC Rear press-fit spacer	DSS4XPFAA54X
50	4-40 UNC Rear press-fit spacer	DSS5XPFAA54X
09	M3 Rear press-fit spacer	DSS1XPFAA53X
15	M3 Rear press-fit spacer	DSS2XPFAA53X
25	M3 Rear press-fit spacer	DSS3XPFAA53X
37	M3 Rear press-fit spacer	DSS4XPFAA53X
50	M3 Rear press-fit spacer	DSS5XPFAA53X

Rear press-fit spacer for .122" / 3.1 ± .004" / 0.10 mm hole diameter and .063" / 1.6 mm circuit board thickness.

D-SUB STANDARD

Wire wrap – Precision machined contacts



RoHS compliant – CSA listed, File No.: LR 115000-1 – UL listed, File No.: E202784

DESCRIPTION

- Mounting styles:
 - with through-hole, $\varnothing .118''/3 \text{ mm}$
 - with 4-40 UNC or M3 threaded insert
- Quality class 3 (also available in quality class 1)
- Shell: Steel tin plated (brass tin plated or stainless steel available on request)

SOCKET CONNECTOR



No. of pos.	A -0.76	B -0.25	C
09	31.19	16.46	25.00 $+0.12$
15	39.52	24.79	33.30 $+0.15$ -0.10
25	53.42	38.50	47.04 $+0.13$
37	69.70	54.96	63.50 $+0.13$
50	67.31	52.55	61.10 $+0.14$ -0.11

Mounting style: Through-hole



Mounting style: Threaded insert

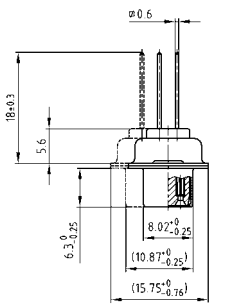

50 pos. = Dim. in (_)

PLUG CONNECTOR

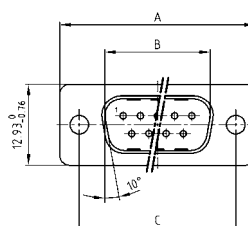

No. of pos.	A -0.76	B -0.25	C	D -0.3
09	31.19	16.79	25.00 $+0.12$	6.12
15	39.52	25.12	33.30 $+0.15$ -0.10	6.12
25	53.42	38.84	47.04 $+0.13$	5.99
37	69.70	55.30	63.50 $+0.13$	5.99
50	67.31	52.68	61.10 $+0.14$ -0.11	5.99

Mounting style: Through-hole

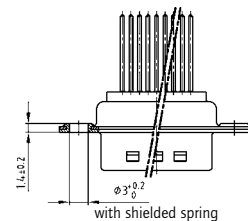

Mounting style: Threaded insert

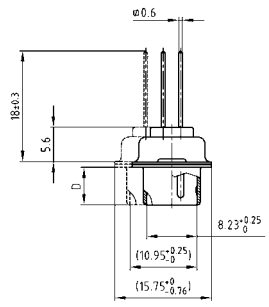
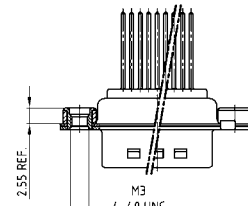

50 pos. = Dim. in (_)

ORDER DATA

SOCKET CONNECTOR		
No. of pos.	Mounting style	Part Number
09	Through-hole	164A10119X
15	Through-hole	164A10129X
25	Through-hole	164A10139X
37	Through-hole	164A10149X
50	Through-hole	164A10159X
09	4-40 UNC Threaded insert	164A10419X
15	4-40 UNC Threaded insert	164A10429X
25	4-40 UNC Threaded insert	164A10439X
37	4-40 UNC Threaded insert	164A10449X
50	4-40 UNC Threaded insert	164A10459X
09	M3 Threaded insert	164A10469X
15	M3 Threaded insert	164A10479X
25	M3 Threaded insert	164A10489X
37	M3 Threaded insert	164A10499X
50	M3 Threaded insert	164A10509X

PLUG CONNECTOR		
No. of pos.	Mounting style	Part Number
09	Through-hole	163A11169X
15	Through-hole	163A11179X
25	Through-hole	163A11189X
37	Through-hole	163A11199X
50	Through-hole	163A11209X
09	4-40 UNC Threaded insert	163A11469X
15	4-40 UNC Threaded insert	163A11479X
25	4-40 UNC Threaded insert	163A11489X
37	4-40 UNC Threaded insert	163A11499X
50	4-40 UNC Threaded insert	163A11509X
09	M3 Threaded insert	163A11519X
15	M3 Threaded insert	163A11529X
25	M3 Threaded insert	163A11539X
37	M3 Threaded insert	163A11549X
50	M3 Threaded insert	163A11559X

D-SUB STANDARD

IDC for flat cable – Stamped contacts – For wire size AWG 26...28



RoHS compliant – CSA listed, File No.: LR 115000-1 – UL listed, File No.: E202784

DESCRIPTION

- For wire size AWG 26...28 flat cable
- Mounting style: with through-hole, Ø .118"/3 mm with 4-40 UNC threaded insert
- Connector includes strain relief
- Quality class 3 (other quality classes on request)
- Shell: Steel tin plated

SOCKET CONNECTOR



No. of pos.	A ±0.25	B ±0.25	C ±0.13	D ±0.25
09	30.80	16.46	25.00	16.10
15	39.10	24.79	33.30	24.00
25	53.09	38.50	47.04	38.14
37	69.40	54.96	63.50	54.60

Mounting style: Through-hole



Upper part grouted with strain relief



Mounting style: Threaded insert



Strain relief



PLUG CONNECTOR

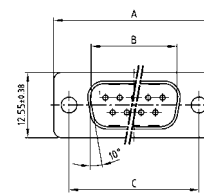

No. of pos.	A ±0.25	B ±0.25	C ±0.13	D ±0.25
09	30.80	16.79	25.00	16.10
15	39.10	25.12	33.30	24.00
25	53.09	83.84	47.04	38.14
37	69.40	55.30	63.50	54.60

Mounting style: Through-hole

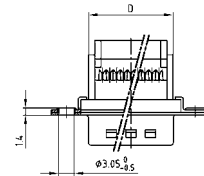

Upper part grouted with strain relief



Mounting style: Threaded insert



Strain relief



ORDER DATA

SOCKET CONNECTOR		
No. of pos.	Mounting style	Part Number
09	Through-hole	302A10089X
15	Through-hole	302A10099X
25	Through-hole	302A10109X
37	Through-hole	302A10119X
09	Threaded insert	DLS1XSSAG04X
15	Threaded insert	DLS2XSSAG04X
25	Threaded insert	DLS3XSSAG04X
37	Threaded insert	DLS4XSSAG04X

PLUG CONNECTOR		
No. of pos.	Mounting style	Part Number
09	Through-hole	301A10089X
15	Through-hole	301A10099X
25	Through-hole	301A10109X
37	Through-hole	301A10119X
09	Threaded insert	DLS1XPSAG04X
15	Threaded insert	DLS2XPSAG04X
25	Threaded insert	DLS3XPSAG04X
37	Threaded insert	DLS4XPSAG04X

D-SUB STANDARD

Solder pin – Angled – .318" / 7.19 mm – Precision machined contacts – Metal bracket

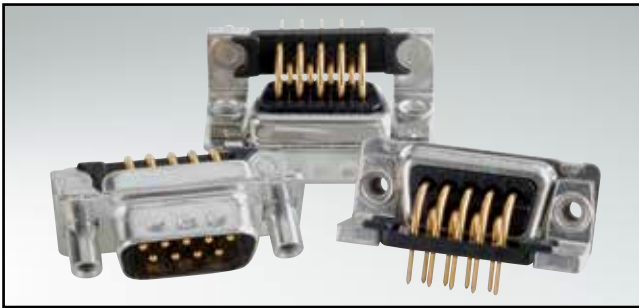

RoHS compliant – CSA listed, File No.: LR 115000-1 – UL listed, File No.: E202784

SOCKET CONNECTOR



No. of pos.	A -0.76	B -0.25	C
09	31.19	16.46	25.00 +0.12
15	39.52	24.79	33.30 +0.15 -0.10
25	53.42	38.50	47.04 +0.13
37	69.70	54.96	63.50 +0.13
50	67.31	52.55	61.10 +0.14 -0.11

PCB-Layout: Kat1kGEA

Mounting style: Threaded insert



50 pos. = Dim. in (_)

DESCRIPTION

- Mounting styles:
 - with mounting bracket and 4-40 UNC or M3 threaded insert
 - with mounting bracket and 4-40 UNC or M3 front spacer
 - with mounting bracket, PCB clip and 4-40 UNC or M3 threaded insert
 - with mounting bracket, PCB clip and 4-40 UNC or M3 front spacer
- Quality class 3 (also available in quality class 1)
- Shell: Steel tin plated (brass tin plated or stainless steel available on request)

PLUG CONNECTOR



No. of pos.	A -0.76	B -0.25	C	D -0.3
09	31.19	16.79	25.00 +0.12	6.12
15	39.52	25.12	33.30 +0.15 -0.10	6.12
25	53.42	38.84	47.04 +0.13	5.99
37	69.70	55.30	63.50 +0.13	5.99
50	67.31	52.68	61.10 +0.14 -0.11	5.99

PCB-Layout: Kat1kGFA

Mounting style: Threaded insert



50 pos. = Dim. in (_)

ORDER DATA

SOCKET CONNECTOR		
No. of pos.	Mounting style	Part Number
09	4-40 UNC Threaded insert	164A11519X
15	4-40 UNC Threaded insert	164A11529X
25	4-40 UNC Threaded insert	164A11539X
37	4-40 UNC Threaded insert	164A11549X
50	4-40 UNC Threaded insert	164A18969X
09	M3 Threaded insert	164A13439X
15	M3 Threaded insert	164A13449X
25	M3 Threaded insert	164A13459X
37	M3 Threaded insert	164A13469X
50	M3 Threaded insert	164A18979X

PLUG CONNECTOR		
No. of pos.	Mounting style	Part Number
09	4-40 UNC Threaded insert	163A13069X
15	4-40 UNC Threaded insert	163A13079X
25	4-40 UNC Threaded insert	163A13089X
37	4-40 UNC Threaded insert	163A13099X
50	4-40 UNC Threaded insert	163A18549X
09	M3 Threaded insert	163A14959X
15	M3 Threaded insert	163A14969X
25	M3 Threaded insert	163A14979X
37	M3 Threaded insert	163A14989X
50	M3 Threaded insert	163A18559X

D-SUB STANDARD – MOUNTING STYLES

Solder pin – Angled – .318" / 7.19 mm – Precision machined contacts – Metal bracket

ORDER DATA

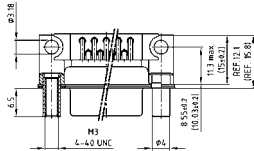

SOCKET CONNECTOR		
No. of pos.	Mounting style	Part Number
09	4-40 UNC Front spacer	164A16929X
15	4-40 UNC Front spacer	164A16939X
25	4-40 UNC Front spacer	164A16949X
37	4-40 UNC Front spacer	164A16959X
50	4-40 UNC Front spacer	164A19019X
09	M3 Front spacer	164A16969X
15	M3 Front spacer	164A16979X
25	M3 Front spacer	164A16989X
37	M3 Front spacer	164A16999X
50	M3 Front spacer	164A19029X

PLUG CONNECTOR		
No. of pos.	Mounting style	Part Number
09	4-40 UNC Front spacer	163A16519X
15	4-40 UNC Front spacer	163A16529X
25	4-40 UNC Front spacer	163A16539X
37	4-40 UNC Front spacer	163A16549X
50	4-40 UNC Front spacer	163A18589X
09	M3 Front spacer	163A16559X
15	M3 Front spacer	163A16569X
25	M3 Front spacer	163A16579X
37	M3 Front spacer	163A16589X
50	M3 Front spacer	163A18599X

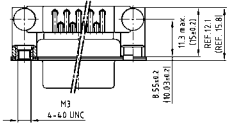

SOCKET CONNECTOR		
No. of pos.	Mounting style	Part Number
09	PCB clip / 4-40 UNC Threaded insert	164A17939X
15	PCB clip / 4-40 UNC Threaded insert	164A17949X
25	PCB clip / 4-40 UNC Threaded insert	164A17959X
37	PCB clip / 4-40 UNC Threaded insert	164A17969X
50	PCB clip / 4-40 UNC Threaded insert	164A18989X
09	PCB clip / M3 Threaded insert	164A17979X
15	PCB clip / M3 Threaded insert	164A17989X
25	PCB clip / M3 Threaded insert	164A17999X
37	PCB clip / M3 Threaded insert	164A18009X
50	PCB clip / M3 Threaded insert	164A18999X

PLUG CONNECTOR		
No. of pos.	Mounting style	Part Number
09	PCB clip / 4-40 UNC Threaded insert	163A17529X
15	PCB clip / 4-40 UNC Threaded insert	163A17539X
25	PCB clip / 4-40 UNC Threaded insert	163A17549X
37	PCB clip / 4-40 UNC Threaded insert	163A17559X
50	PCB clip / 4-40 UNC Threaded insert	163A18569X
09	PCB clip / M3 Threaded insert	163A17569X
15	PCB clip / M3 Threaded insert	163A17579X
25	PCB clip / M3 Threaded insert	163A17589X
37	PCB clip / M3 Threaded insert	163A17599X
50	PCB clip / M3 Threaded insert	163A18579X

PCB clip .122" / 3.1 ± .004" / 0.10 mm hole diameter and .063" / 1.6 mm circuit board thickness

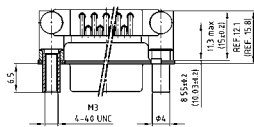

SOCKET CONNECTOR		
No. of pos.	Mounting style	Part Number
09	PCB clip / 4-40 UNC Front spacer	164A19039X
15	PCB clip / 4-40 UNC Front spacer	164A19049X
25	PCB clip / 4-40 UNC Front spacer	164A19059X
37	PCB clip / 4-40 UNC Front spacer	164A19069X
50	PCB clip / 4-40 UNC Front spacer	164A19079X
09	PCB clip / M3 Front spacer	164A19089X
15	PCB clip / M3 Front spacer	164A19099X
25	PCB clip / M3 Front spacer	164A19109X
37	PCB clip / M3 Front spacer	164A19119X
50	PCB clip / M3 Front spacer	164A19129X

PLUG CONNECTOR		
No. of pos.	Mounting style	Part Number
09	PCB clip / 4-40 UNC Front spacer	163A18609X
15	PCB clip / 4-40 UNC Front spacer	163A18619X
25	PCB clip / 4-40 UNC Front spacer	163A18629X
37	PCB clip / 4-40 UNC Front spacer	163A18639X
50	PCB clip / 4-40 UNC Front spacer	163A18649X
09	PCB clip / M3 Front spacer	163A18659X
15	PCB clip / M3 Front spacer	163A18669X
25	PCB clip / M3 Front spacer	163A18679X
37	PCB clip / M3 Front spacer	163A18689X
50	PCB clip / M3 Front spacer	163A18699X

PCB clip .122" / 3.1 ± .004" / 0.10 mm hole diameter and .063" / 1.6 mm circuit board thickness

PCB-Layout: Kat1kGEA

PCB-Layout: Kat1kGFA

D-SUB STANDARD

Solder pin – Angled – .318" / 7.19 mm – Precision machined contacts – Plastic bracket

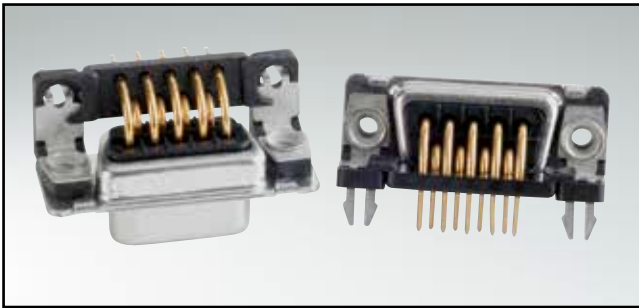

RoHS compliant – CSA listed, File No.: LR 115000-1 – UL listed, File No.: E202784

SOCKET CONNECTOR

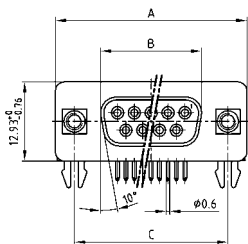

No. of pos.	A -0.76	B -0.25	C
09	31.19	16.46	25.00 ±0.12
15	39.52	24.79	33.30 ^{+0.15} / _{-0.10}
25	53.42	38.50	47.04 ±0.13
37	69.70	54.96	63.50 ±0.13

PCB-Layout: Kat1kGEA

Mounting style: PCB clip, threaded insert



Mounting style: PCB clip, front spacer



DESCRIPTION

- Mounting styles:
 - with mounting bracket, PCB clip and 4-40 UNC or M3 threaded insert
 - with mounting bracket, PCB clip and 4-40 UNC or M3 front spacer
- Quality class 3 (also available in quality class 1)
- Shell: Steel tin plated (brass tin plated or stainless steel available on request)

PLUG CONNECTOR

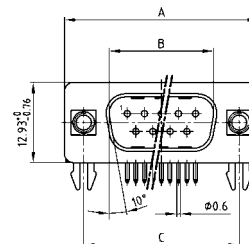

No. of pos.	A -0.76	B +0.25	C	D -0.3
09	31.19	16.79	25.00 ±0.12	6.12
15	39.52	25.12	33.30 ^{+0.15} / _{-0.10}	6.12
25	53.42	38.84	47.04 ±0.13	5.99
37	69.70	55.30	63.50 ±0.13	5.99

PCB-Layout: Kat1kGFA

Mounting style: PCB clip, threaded insert



Mounting style: PCB clip, front spacer

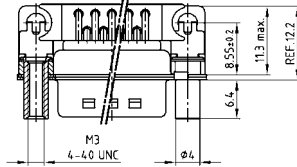

ORDER DATA

SOCKET CONNECTOR		
No. of pos.	Mounting style	Part Number
09	PCB clip / 4-40 UNC Threaded insert	164A18809X
15	PCB clip / 4-40 UNC Threaded insert	164A18819X
25	PCB clip / 4-40 UNC Threaded insert	164A18829X
37	PCB clip / 4-40 UNC Threaded insert	164A18839X
09	PCB clip / M3 Threaded insert	164A18849X
15	PCB clip / M3 Threaded insert	164A18859X
25	PCB clip / M3 Threaded insert	164A18869X
37	PCB clip / M3 Threaded insert	164A18879X
09	PCB clip / 4-40 UNC Front spacer	164A18889X
15	PCB clip / 4-40 UNC Front spacer	164A18899X
25	PCB clip / 4-40 UNC Front spacer	164A18909X
37	PCB clip / 4-40 UNC Front spacer	164A18919X
09	PCB clip / M3 Front spacer	164A18929X
15	PCB clip / M3 Front spacer	164A18939X
25	PCB clip / M3 Front spacer	164A18949X
37	PCB clip / M3 Front spacer	164A18959X

PLUG CONNECTOR		
No. of pos.	Mounting style	Part Number
09	PCB clip / 4-40 UNC Threaded insert	163A18389X
15	PCB clip / 4-40 UNC Threaded insert	163A18399X
25	PCB clip / 4-40 UNC Threaded insert	163A18409X
37	PCB clip / 4-40 UNC Threaded insert	163A18419X
09	PCB clip / M3 Threaded insert	163A18429X
15	PCB clip / M3 Threaded insert	163A18439X
25	PCB clip / M3 Threaded insert	163A18449X
37	PCB clip / M3 Threaded insert	163A18459X
09	PCB clip / 4-40 UNC Front spacer	163A18469X
15	PCB clip / 4-40 UNC Front spacer	163A18479X
25	PCB clip / 4-40 UNC Front spacer	163A18489X
37	PCB clip / 4-40 UNC Front spacer	163A18499X
09	PCB clip / M3 Front spacer	163A18509X
15	PCB clip / M3 Front spacer	163A18519X
25	PCB clip / M3 Front spacer	163A18529X
37	PCB clip / M3 Front spacer	163A18539X

PCB clip .122" / 3.1 ± .004" / 0.10 mm hole diameter and .063" / 1.6 mm circuit board thickness

D-SUB STANDARD

Solder pin – Angled – .318" / 7.19 mm – Stamped contacts – Plastic bracket



RoHS compliant – CSA listed, File No.: LR 115000-1 – UL listed, File No.: E202784

DESCRIPTION

- Mounting styles:
 - with mounting bracket, PCB clip and 4-40 UNC threaded insert
 - with mounting bracket, PCB clip and 4-40 UNC hex bolt
- Quality class 3 (other quality classes on request)
- Shell: Steel tin plated

SOCKET CONNECTOR

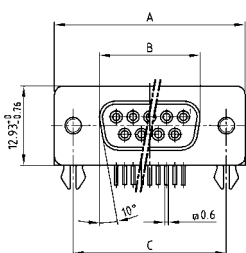

No. of pos.	A -0.76	B -0.25	C
09	31.19	16.46	25.00 ±0.12
15	39.52	24.79	33.30 ±0.15 ±0.10
25	53.42	38.50	47.04 ±0.13
37	69.70	54.96	63.50 ±0.13

Mounting style: PCB clip, threaded insert



Mounting style: PCB clip, front spacer

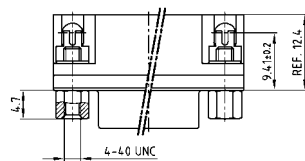

PLUG CONNECTOR



No. of pos.	A -0.76	B +0.25	C	D -0.3
09	31.19	16.79	25.00 ±0.12	6.12
15	39.52	25.12	33.30 ±0.15 ±0.10	6.12
25	53.42	38.84	47.04 ±0.13	5.99
37	69.70	55.30	63.50 ±0.13	5.99

Mounting style: PCB clip, threaded insert



Mounting style: PCB clip, front spacer

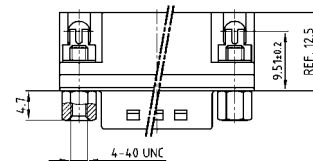

ORDER DATA

SOCKET CONNECTOR		
No. of pos.	Mounting style 4-40 UNC	Part Number
09	PCB clip/Threaded insert	302A11339X
15	PCB clip/Threaded insert	302A11349X
25	PCB clip/Threaded insert	302A11359X
37	PCB clip/Threaded insert	302A11369X
09	PCB clip/Hex bolt	302A11249X
15	PCB clip/Hex bolt	302A11259X
25	PCB clip/Hex bolt	302A11269X
37	PCB clip/Hex bolt	302A11279X

PLUG CONNECTOR		
No. of pos.	Mounting style 4-40 UNC	Part Number
09	PCB clip/Threaded insert	301A11029X
15	PCB clip/Threaded insert	301A11039X
25	PCB clip/Threaded insert	301A11049X
37	PCB clip/Threaded insert	301A11059X
09	PCB clip/Front spacer	301A10939X
15	PCB clip/Front spacer	301A10949X
25	PCB clip/Front spacer	301A10959X
37	PCB clip/Front spacer	301A10969X

PCB clip .122" / 3.1 ± .004" / 0.10 mm hole diameter and .063" / 1.6 mm circuit board thickness

D-SUB STANDARD

Solder pin – Angled – .370"/9.4 mm – Precision machined contacts – Plastic bracket



RoHS compliant – CSA listed, File No.: LR 115000-1 – UL listed, File No.: E202784

SOCKET CONNECTOR



No. of pos.	A -0.76	B -0.25	C
09	31.19	16.46	25.00 +0.12
15	39.52	24.79	33.30 +0.15 -0.10
25	53.42	38.50	47.04 +0.13
37	69.70	54.96	63.50 +0.13
50	67.31	52.55	61.10 +0.14 -0.11

PCB-Layout: Kat1kGGA

Mounting style: Through-hole



50 pos. = Dim. in (_)



Mounting style: Threaded insert



DESCRIPTION

- Mounting styles:
 - with mounting bracket and $\varnothing .118"/3$ mm through-hole
 - with mounting bracket, grounding strap and 4-40 UNC or M3 threaded insert
 - with mounting bracket, grounding strap and 4-40 UNC or M3 front spacer
 - with mounting bracket, PCB clip and 4-40 UNC or M3 threaded insert
 - with mounting bracket, PCB clip and 4-40 UNC or M3 front spacer
- Quality class 3 (also available in quality class 1)
- Shell: Steel tin plated (brass tin plated or stainless steel available on request)

PLUG CONNECTOR



No. of pos.	A -0.76	B -0.25	C	D -0.3
09	31.19	16.79	25.00 +0.12	6.12
15	39.52	25.12	33.30 +0.15 -0.10	6.12
25	53.42	38.84	47.04 +0.13	5.99
37	69.70	55.30	63.50 +0.13	5.99
50	67.31	52.68	61.10 +0.14 -0.11	5.99

PCB-Layout: Kat1kGHA

Mounting style: Through-hole



50 pos. = Dim. in (_)



Mounting style: Threaded insert

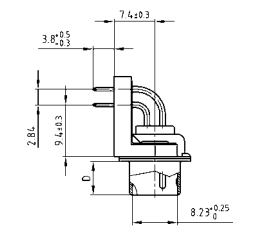
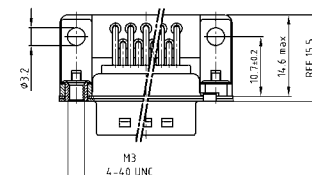

ORDER DATA

SOCKET CONNECTOR		
No. of pos.	Mounting style	Part Number
09	Through-hole	164A10669X
15	Through-hole	164A10679X
25	Through-hole	164A10689X
37	Through-hole	164A10699X
50	Through-hole	164A10709X
09	Grounding strap/4-40 UNC Threaded insert	164A12329X
15	Grounding strap/4-40 UNC Threaded insert	164A12339X
25	Grounding strap/4-40 UNC Threaded insert	164A12349X
37	Grounding strap/4-40 UNC Threaded insert	164A12359X
09	Grounding strap/M3 Threaded insert	164A12519X
15	Grounding strap/M3 Threaded insert	164A12529X
25	Grounding strap/M3 Threaded insert	164A12539X
37	Grounding strap/M3 Threaded insert	164A12549X

PLUG CONNECTOR		
No. of pos.	Mounting style	Part Number
09	Through-hole	163A11719X
15	Through-hole	163A11729X
25	Through-hole	163A11739X
37	Through-hole	163A11749X
50	Through-hole	163A11759X
09	Grounding strap/4-40 UNC Threaded insert	163A14119X
15	Grounding strap/4-40 UNC Threaded insert	163A14129X
25	Grounding strap/4-40 UNC Threaded insert	163A14139X
37	Grounding strap/4-40 UNC Threaded insert	163A14149X
09	Grounding strap/M3 Threaded insert	163A14169X
15	Grounding strap/M3 Threaded insert	163A14179X
25	Grounding strap/M3 Threaded insert	163A14189X
37	Grounding strap/M3 Threaded insert	163A14199X

D-SUB STANDARD – MOUNTING STYLES

Solder pin – Angled – .370"/9.4 mm – Precision machined contacts – Plastic bracket

ORDER DATA

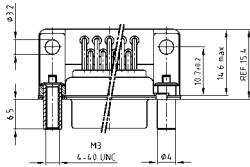

SOCKET CONNECTOR		
No. of pos.	Mounting style	Part Number
09	Grounding strap/4-40 UNC Front spacer	164A12229X
15	Grounding strap/4-40 UNC Front spacer	164A12239X
25	Grounding strap/4-40 UNC Front spacer	164A12249X
37	Grounding strap/4-40 UNC Front spacer	164A12259X
09	Grounding strap/M3 Front spacer	164A12279X
15	Grounding strap/M3 Front spacer	164A12289X
25	Grounding strap/M3 Front spacer	164A12299X
37	Grounding strap/M3 Front spacer	164A12309X

PLUG CONNECTOR		
No. of pos.	Mounting style	Part Number
09	Grounding strap/4-40 UNC Front spacer	163A13829X
15	Grounding strap/4-40 UNC Front spacer	163A13839X
25	Grounding strap/4-40 UNC Front spacer	163A13849X
37	Grounding strap/4-40 UNC Front spacer	163A13859X
09	Grounding strap/M3 Front spacer	163A13879X
15	Grounding strap/M3 Front spacer	163A13889X
25	Grounding strap/M3 Front spacer	163A13899X
37	Grounding strap/M3 Front spacer	163A13909X



SOCKET CONNECTOR		
No. of pos.	Mounting style	Part Number
09	PCB clip/4-40 UNC Threaded insert	164A12969X
15	PCB clip/4-40 UNC Threaded insert	164A12979X
25	PCB clip/4-40 UNC Threaded insert	164A12989X
37	PCB clip/4-40 UNC Threaded insert	164A12999X
50	PCB clip/4-40 UNC Threaded insert	164A19139X
09	PCB clip/M3 Threaded insert	164A13009X
15	PCB clip/M3 Threaded insert	164A13019X
25	PCB clip/M3 Threaded insert	164A13029X
37	PCB clip/M3 Threaded insert	164A13039X
50	PCB clip/M3 Threaded insert	164A19149X

PLUG CONNECTOR		
No. of pos.	Mounting style	Part Number
09	PCB clip/4-40 UNC Threaded insert	163A14489X
15	PCB clip/4-40 UNC Threaded insert	163A14499X
25	PCB clip/4-40 UNC Threaded insert	163A14509X
37	PCB clip/4-40 UNC Threaded insert	163A14519X
50	PCB clip/4-40 UNC Threaded insert	163A18709X
09	PCB clip/M3 Threaded insert	163A14529X
15	PCB clip/M3 Threaded insert	163A14539X
25	PCB clip/M3 Threaded insert	163A14549X
37	PCB clip/M3 Threaded insert	163A14559X
50	PCB clip/M3 Threaded insert	163A18719X

PCB clip .122"/3.1 ± .004"/0.10 mm hole diameter and .063"/1.6 mm circuit board thickness



SOCKET CONNECTOR		
No. of pos.	Mounting style	Part Number
09	PCB clip/4-40 UNC Front spacer	164A13089X
15	PCB clip/4-40 UNC Front spacer	164A13099X
25	PCB clip/4-40 UNC Front spacer	164A13109X
37	PCB clip/4-40 UNC Front spacer	164A13119X
50	PCB clip/4-40 UNC Front spacer	164A19159X
09	PCB clip/M3 Front spacer	164A13129X
15	PCB clip/M3 Front spacer	164A13139X
25	PCB clip/M3 Front spacer	164A13149X
37	PCB clip/M3 Front spacer	164A13159X
50	PCB clip/M3 Front spacer	164A19169X

PLUG CONNECTOR		
No. of pos.	Mounting style	Part Number
09	PCB clip/4-40 UNC Front spacer	163A14609X
15	PCB clip/4-40 UNC Front spacer	163A14619X
25	PCB clip/4-40 UNC Front spacer	163A14629X
37	PCB clip/4-40 UNC Front spacer	163A14639X
50	PCB clip/4-40 UNC Front spacer	163A18729X
09	PCB clip/M3 Front spacer	163A14649X
15	PCB clip/M3 Front spacer	163A14659X
25	PCB clip/M3 Front spacer	163A14669X
37	PCB clip/M3 Front spacer	163A14679X
50	PCB clip/M3 Front spacer	163A18739X

PCB clip .122"/3.1 ± .004"/0.10 mm hole diameter and .063"/1.6 mm circuit board thickness

PCB-Layout: Kat1kGGA

PCB-Layout: Kat1kGHA