



Chipsmall Limited consists of a professional team with an average of over 10 year of expertise in the distribution of electronic components. Based in Hongkong, we have already established firm and mutual-benefit business relationships with customers from,Europe,America and south Asia,supplying obsolete and hard-to-find components to meet their specific needs.

With the principle of “Quality Parts,Customers Priority,Honest Operation,and Considerate Service”,our business mainly focus on the distribution of electronic components. Line cards we deal with include Microchip,ALPS,ROHM,Xilinx,Pulse,ON,Everlight and Freescale. Main products comprise IC,Modules,Potentiometer,IC Socket,Relay,Connector.Our parts cover such applications as commercial,industrial, and automotives areas.

We are looking forward to setting up business relationship with you and hope to provide you with the best service and solution. Let us make a better world for our industry!



Contact us

Tel: +86-755-8981 8866 Fax: +86-755-8427 6832

Email & Skype: info@chipsmall.com Web: www.chipsmall.com

Address: A1208, Overseas Decoration Building, #122 Zhenhua RD., Futian, Shenzhen, China



THIS DRAWING IS UNPUBLISHED. RELEASED FOR PUBLICATION 20
 © 2016 COMMSCOPE, INC. CONFIDENTIAL NOTICE: THESE DRAWINGS AND SPECIFICATIONS ARE THE PROPRIETARY PROPERTY OF COMMSCOPE, INC. AND MAY BE USED ONLY FOR THE SPECIFIC PURPOSE AUTHORIZED IN WRITING BY COMMSCOPE, INC.

IV 00

REVISIONS					
P	LTR	DESCRIPTION	DATE	DWN	APVD
B3		PN's added	14NOV2013	HB	DT
B4		PN's added	14 JAN2014	HB	DT
C		ECR-14-008920	24 JUN2014	HB	DT
D		REV PER ECN 8000017947	19DEC2016	GG	AS

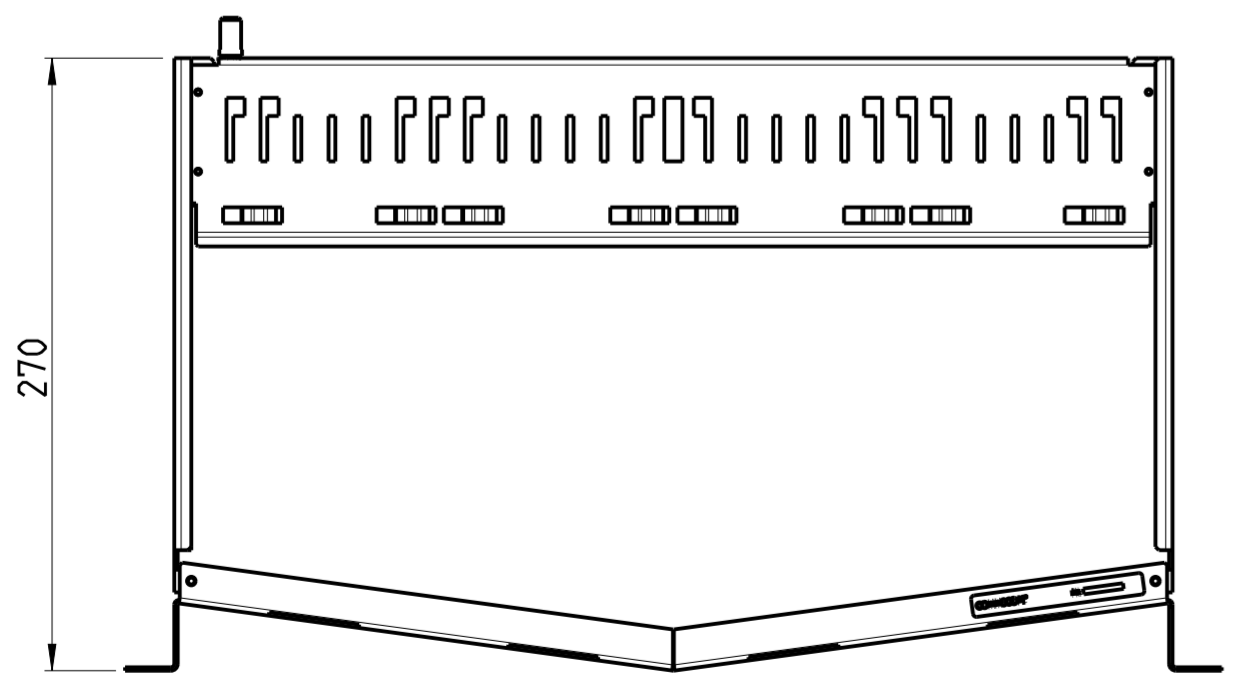
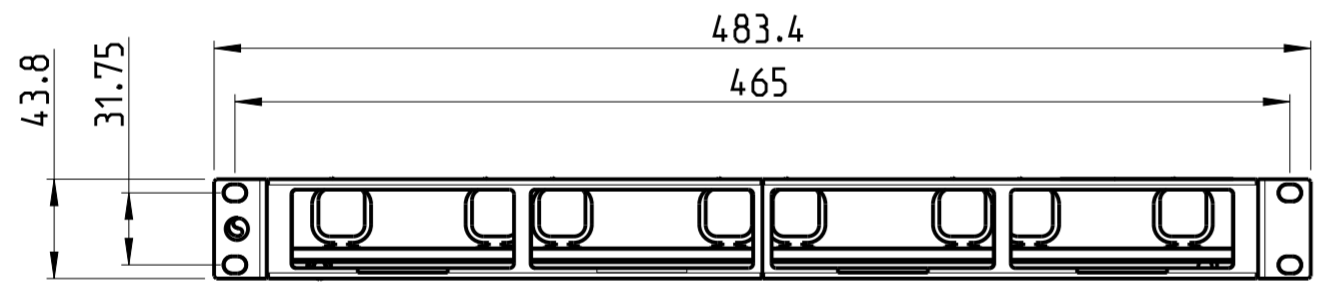
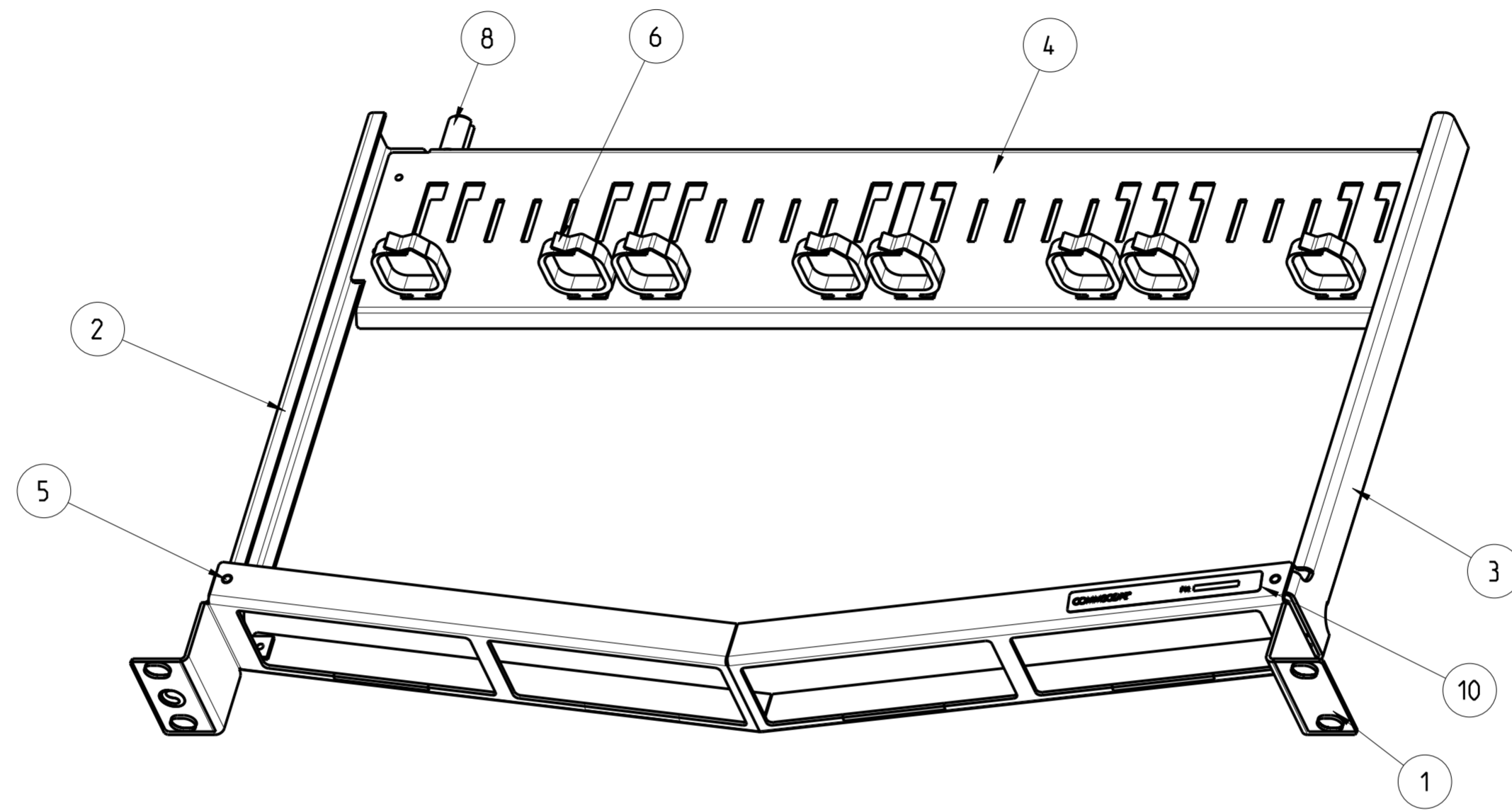

Item 6, 7, 8, 13 and 14 packed in small polybag.

QTY	DESCRIPTION	ITEM
1	Screws 10-32 (UNC)	14
1	Screws 12-24 (UNC)	13
-	UCP - 4U angled frontplate	12
1	UCP - 2U angled frontplate	11
1	Label	10
-	Instruction sheet	9
-	Grounding screw	8
-	Mushroom and knit loop fastener	7
-	OFN saddle	6
-	Spot Fast Fastener SF-3-1.6-ZI	5
-	UCP - cable support bar	4
-	UCP - side bracket right	3
-	UCP - side bracket left	2
-	UCP - angled frontplate	1

THIS DRAWING IS A CONTROLLED DOCUMENT.

DWN H.BLEUS 15OCT2013
 CHK H.BLEUS 15OCT2013
 APVD D.THUIS 15OCT2013

COMMSCOPE, INC.

NAME UCP panel

SIZE A2 CAGE CODE 00779 DRAWING NO C-1671590 RESTRICTED TO -

MATERIAL - FINISH - WEIGHT -

CUSTOMER DRAWING SCALE 1:2 SHEET 1 OF 3 REV D

THIS DRAWING IS UNPUBLISHED. RELEASED FOR PUBLICATION 2013
 © 2016 COMMSCOPE INC. CONFIDENTIAL NOTICE: THESE DRAWINGS AND SPECIFICATIONS ARE THE PROPRIETARY PROPERTY OF COMMSCOPE, INC. AND MAY BE USED ONLY FOR THE SPECIFIC PURPOSE AUTHORIZED IN WRITING BY COMMSCOPE, INC.

00 00

REVISIONS				
P	LTR	DESCRIPTION	DATE	APVD
-		SEE SHEET 1	-	-

1671590-1
Part N°

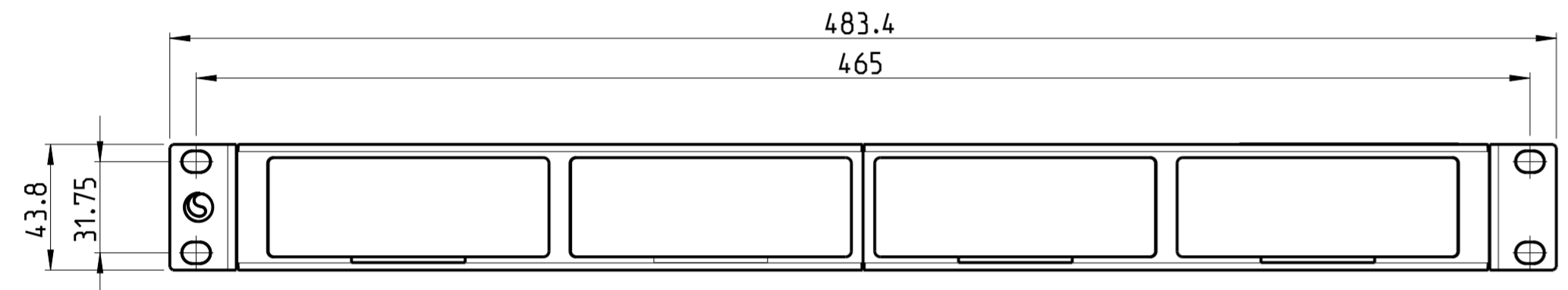
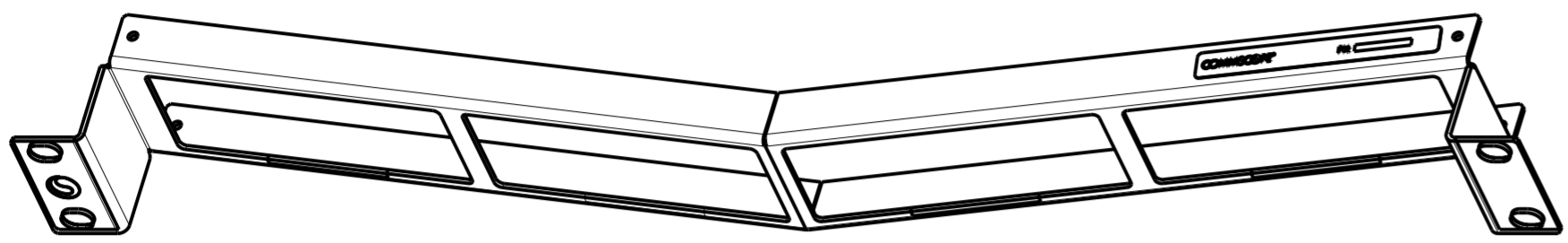

1671590-2
Part N°

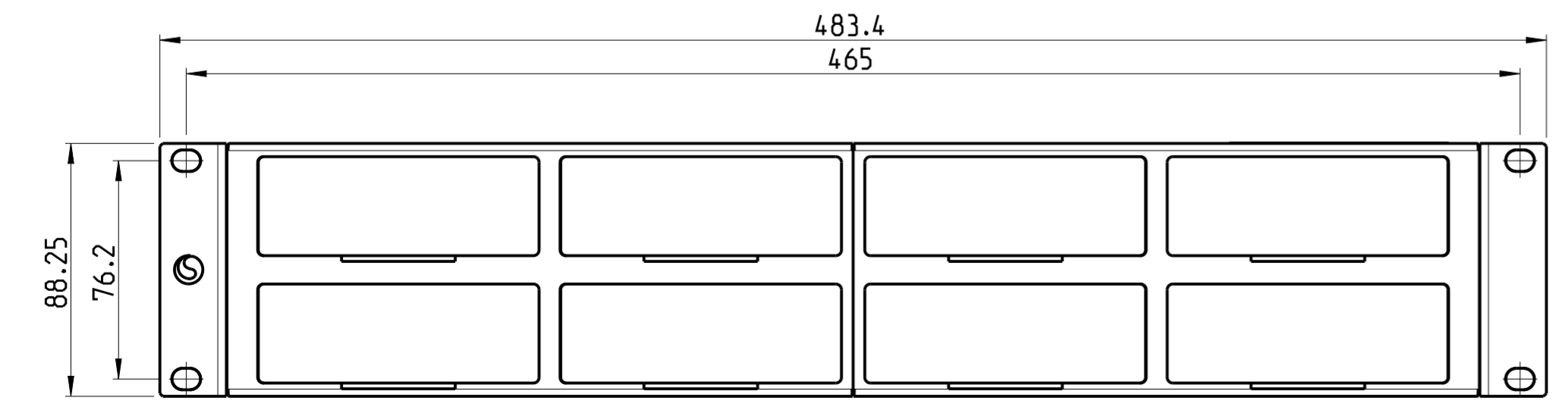
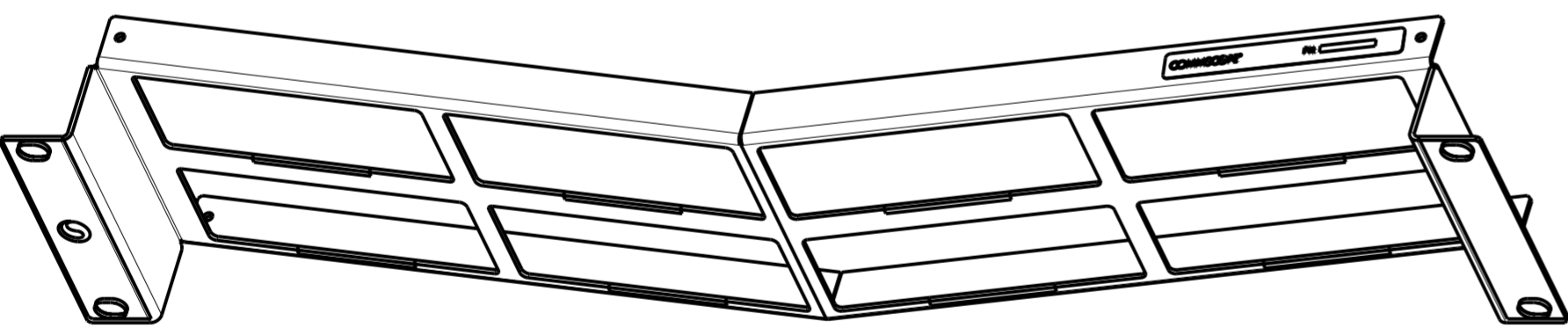

1671590-4
Part N°

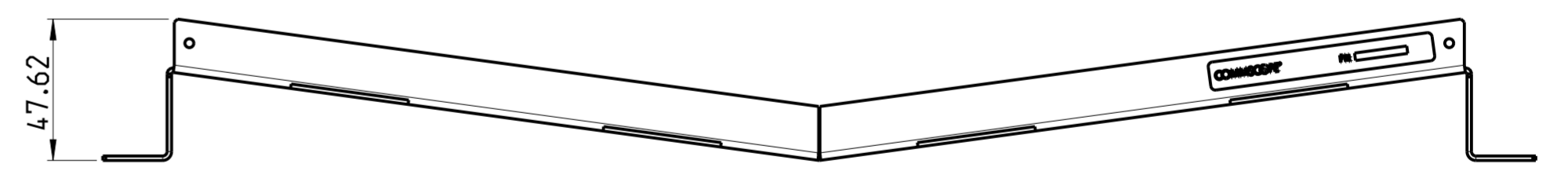
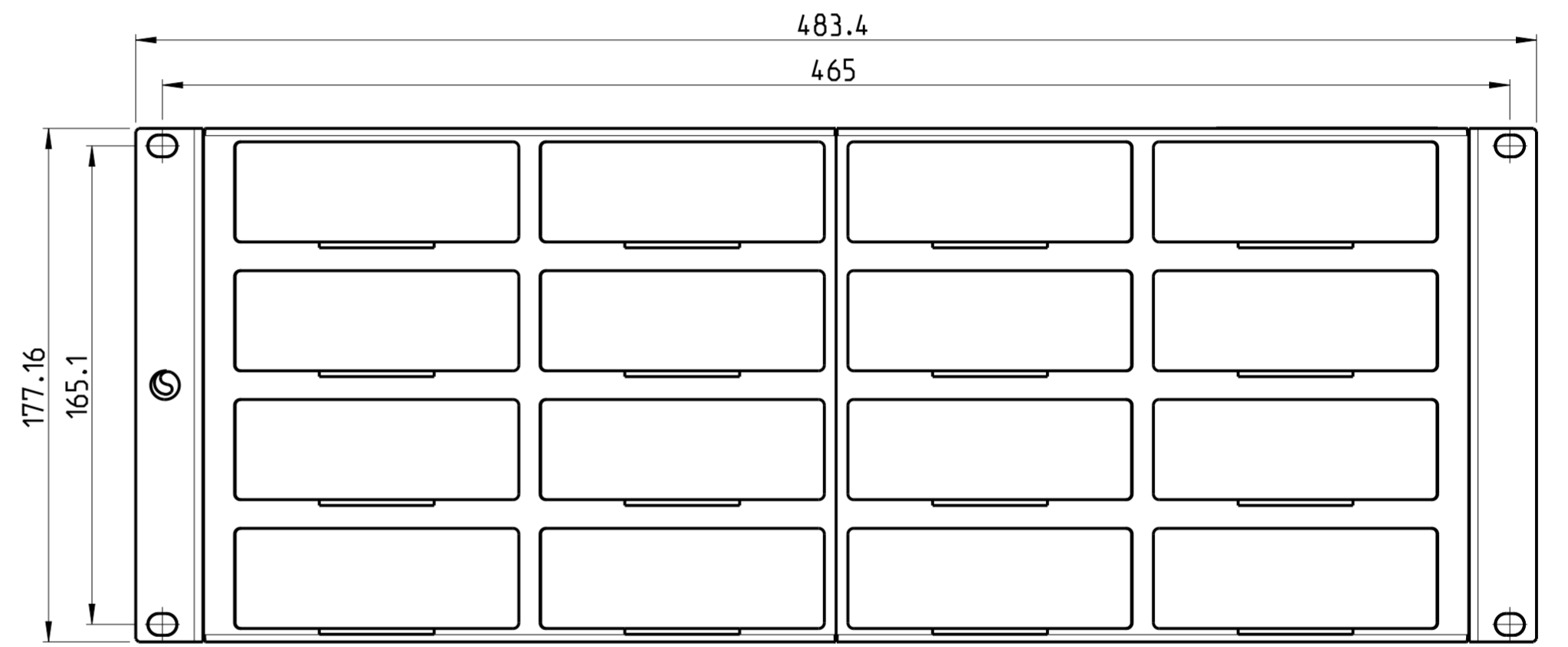
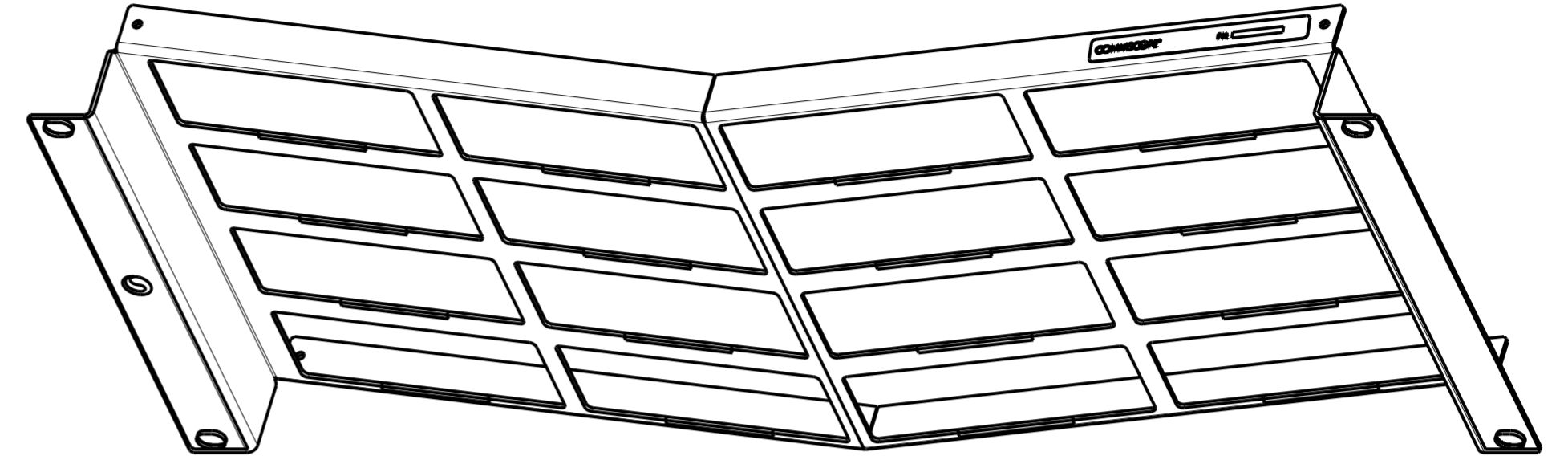

47.62

THIS DRAWING IS A CONTROLLED DOCUMENT.		DWN H.BLEUS 15OCT2013	COMMSCOPE, INC.	
DIMENSIONS: mm		CHK H.BLEUS 15OCT2013		
TOLERANCES UNLESS OTHERWISE SPECIFIED:		APVD D.THLJS 15OCT2013	NAME UCP panel	
0 PLC ±	1 PLC ±	PRODUCT SPEC	-	
2 PLC ±	3 PLC ±	APPLICATION SPEC	-	
4 PLC ±	ANGLES ±1	WEIGHT	-	
MATERIAL	FINISH	CUSTOMER DRAWING	SIZE A2	CAGE CODE 00779
			DRAWING NO. C-1671590	RESTRICTED TO
			SCALE 1:2	SHEET 2 OF 3
			REV D	

THIS DRAWING IS UNPUBLISHED. RELEASED FOR PUBLICATION 2013
 © 2016 COMMSCOPE INC. CONFIDENTIAL NOTICE: THESE DRAWINGS AND SPECIFICATIONS ARE THE PROPRIETARY PROPERTY OF COMMSCOPE, INC. AND MAY BE USED ONLY FOR THE SPECIFIC PURPOSE AUTHORIZED IN WRITING BY COMMSCOPE, INC.

00 00

REVISIONS				
P	LTR	DESCRIPTION	DATE	APVD
-		SEE SHEET 1	-	-

1671590-5
Part N°

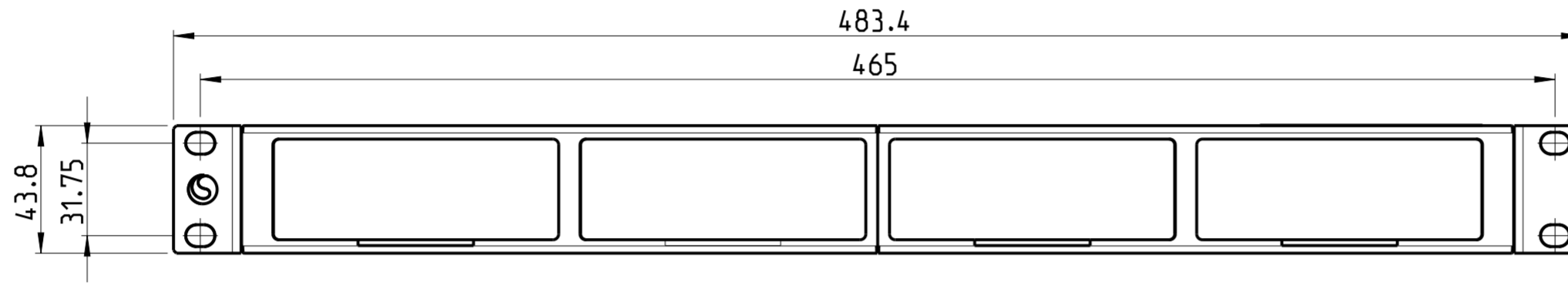
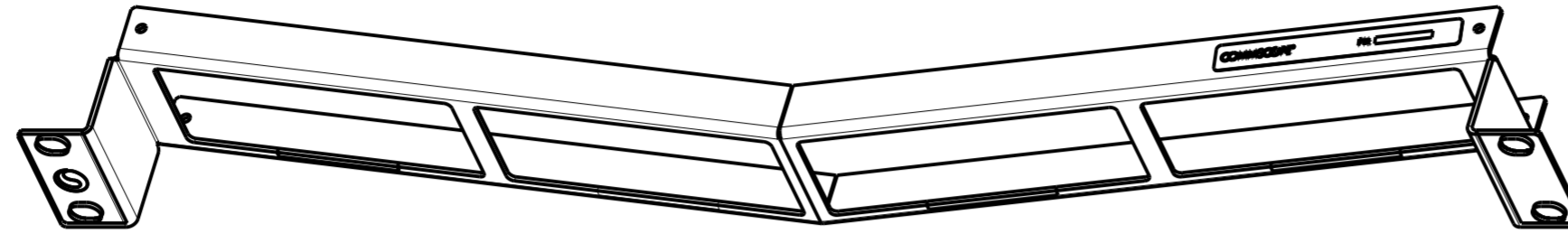

REMARK:
 12-24 screws (UNC)
 10-32 screws (UNC)
 included with this part number.

1671590-6
Part N°

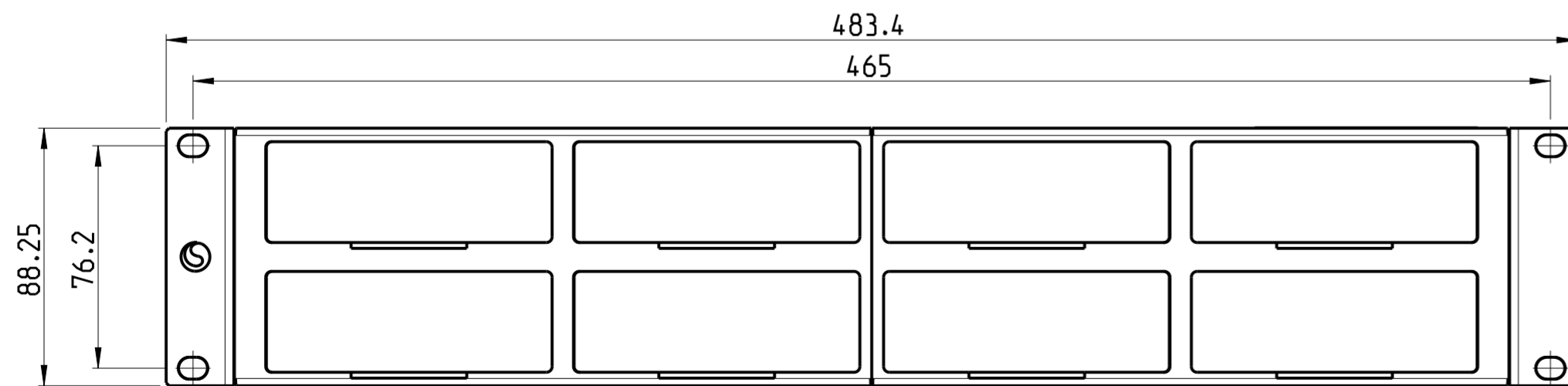
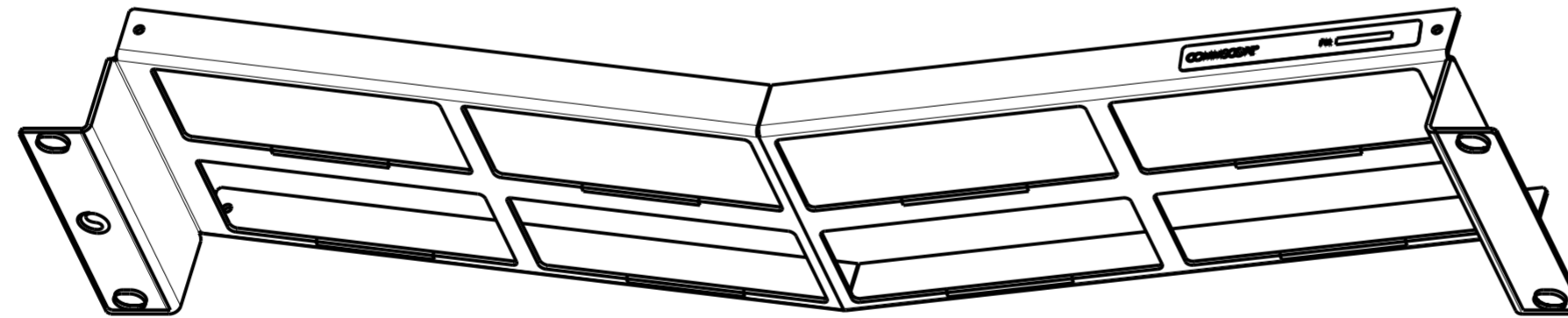

REMARK:
 12-24 screws (UNC)
 10-32 screws (UNC)
 included with this part number.

THIS DRAWING IS A CONTROLLED DOCUMENT.		DWN H.BLEUS 15OCT2013	COMMSCOPE, INC.		
DIMENSIONS: mm		CHK H.BLEUS 15OCT2013			
TOLERANCES UNLESS OTHERWISE SPECIFIED:		APVD D.THLJS 15OCT2013	PRODUCT SPEC -		
0 PLC ±		APVD	APPLICATION SPEC -		
1 PLC ±		PRODUCT SPEC	WEIGHT -		
2 PLC ±		APVD	RESTRICTED TO -		
3 PLC ±		APPLICATION SPEC	SIZE A2		
4 PLC ±		WEIGHT	CAGE CODE 00779		
ANGLES ±1		FINISH	DRAWING NO C-1671590		
MATERIAL -		CUSTOMER DRAWING	SCALE 1:2		
			SHEET 3 OF 3		
			REV D		