



Chipsmall Limited consists of a professional team with an average of over 10 year of expertise in the distribution of electronic components. Based in Hongkong, we have already established firm and mutual-benefit business relationships with customers from,Europe,America and south Asia,supplying obsolete and hard-to-find components to meet their specific needs.

With the principle of “Quality Parts,Customers Priority,Honest Operation,and Considerate Service”,our business mainly focus on the distribution of electronic components. Line cards we deal with include Microchip,ALPS,ROHM,Xilinx,Pulse,ON,Everlight and Freescale. Main products comprise IC,Modules,Potentiometer,IC Socket,Relay,Connector.Our parts cover such applications as commercial,industrial, and automotives areas.

We are looking forward to setting up business relationship with you and hope to provide you with the best service and solution. Let us make a better world for our industry!



## Contact us

Tel: +86-755-8981 8866 Fax: +86-755-8427 6832

Email & Skype: info@chipsmall.com Web: www.chipsmall.com

Address: A1208, Overseas Decoration Building, #122 Zhenhua RD., Futian, Shenzhen, China



# HC-A 10-EBUC

Order No.: 1676983

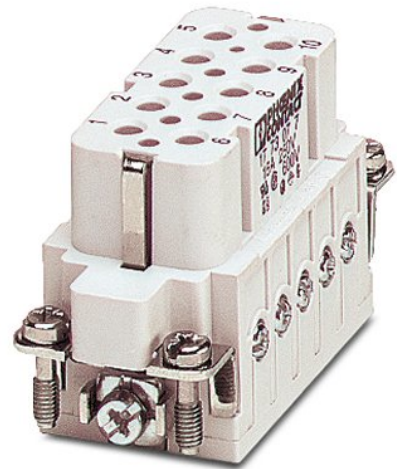

<http://eshop.phoenixcontact.de/phoenix/treeViewClick.do?UID=1676983>

HEAVYCON female insert, A10 series, 10-pos., crimp connection

Commercial data	
GTIN (EAN)	 4 017918 129606
sales group	D014
Pack	10 pcs.
Customs tariff	85366990
Catalog page information	Page 424 (PC-2009)

#### Product notes

WEEE/RoHS-compliant since:  
03/01/2006



<http://www.download.phoenixcontact.com>  
Please note that the data given here has been taken from the online catalog. For comprehensive information and data, please refer to the user documentation. The General Terms and Conditions of Use apply to Internet downloads.

## Technical data

General data	
Note	For HC-D25 housing, crimp contact CK2,5-ED (crimp contacts not included in scope of supply)
Connection method	Crimp connection
Ambient temperature (operation)	-40 °C ... 125 °C (including heating up of contacts)

Pollution degree	3
Surge voltage category	III
Constructional and testing regulations	DIN VDE 0627/86
	DIN VDE 0110/02.79
	DIN VDE 0110-1/04.97
	IEC 60664-1, DIN IEC 60512
	IEC 60352
Number of positions	10
Insertion/withdrawal cycles	≥ 500
Design	A10
Connection in acc. with standard	IEC / EN
Conductor cross-section	0.5 mm <sup>2</sup> ... 4 mm <sup>2</sup>
Connection cross-section AWG	20 ... 12
Stripping length of the individual wire	8 mm
Assembly instructions	Connectors may be operated only when there is no load/voltage.

#### Material data

Inflammability class acc. to UL 94	V0
Contact material	Copper alloy
Contact surface material	Ag (alternatively Au)
Contact carrier material	PA

#### Electrical characteristics

Rated voltage (III/3)	250 V
Rated surge voltage	4 kV
Rated current	16 A

#### Certificates / Approvals



Certification

CSA, GOST, UL

**Accessories**

Item	Designation	Description
------	-------------	-------------

**General**

1584868	HC-A-PES	PE screw for contact inserts of A series
1772722	HC-CB	Coding pin, prevents mismatching of up to six plug connectors with an identical number of positions
1676860	HC-CBU	Keying socket for coding up to 16 plug connectors
1676857	HC-CST	Keying peg for coding up to 16 plug connectors

**Diagrams/Drawings**

**Diagram**

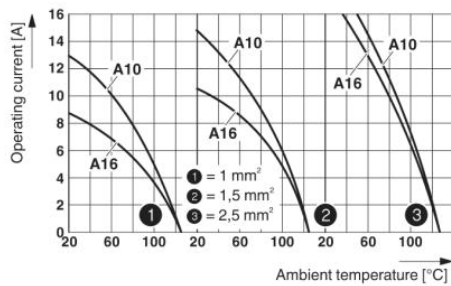

Derating diagram: HC-A...C series

**Dimensioned drawing**

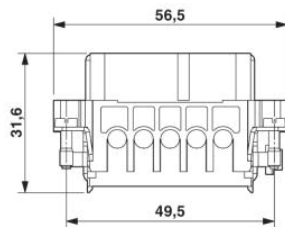

Female insert

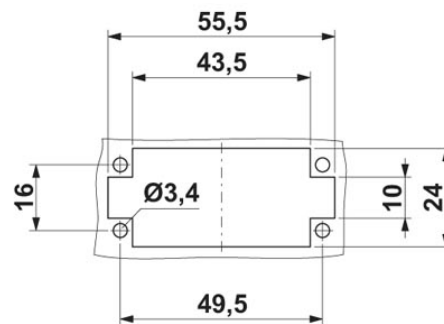
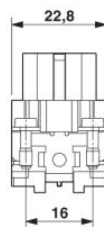

Panel cutout



Schematic diagram

---

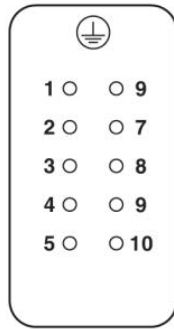
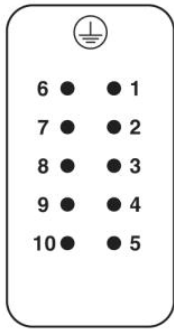

Connector pin assignment, connection side

**Address**

PHOENIX CONTACT Inc., USA  
586 Fulling Mill Road  
Middletown, PA 17057, USA  
Phone (800) 888-7388  
Fax (717) 944-1625  
<http://www.phoenixcon.com>



© 2010 Phoenix Contact  
Technical modifications reserved;