



Chipsmall Limited consists of a professional team with an average of over 10 year of expertise in the distribution of electronic components. Based in Hongkong, we have already established firm and mutual-benefit business relationships with customers from,Europe,America and south Asia,supplying obsolete and hard-to-find components to meet their specific needs.

With the principle of “Quality Parts,Customers Priority,Honest Operation,and Considerate Service”,our business mainly focus on the distribution of electronic components. Line cards we deal with include Microchip,ALPS,ROHM,Xilinx,Pulse,ON,Everlight and Freescale. Main products comprise IC,Modules,Potentiometer,IC Socket,Relay,Connector.Our parts cover such applications as commercial,industrial, and automotives areas.

We are looking forward to setting up business relationship with you and hope to provide you with the best service and solution. Let us make a better world for our industry!



## Contact us

Tel: +86-755-8981 8866 Fax: +86-755-8427 6832

Email & Skype: info@chipsmall.com Web: www.chipsmall.com

Address: A1208, Overseas Decoration Building, #122 Zhenhua RD., Futian, Shenzhen, China



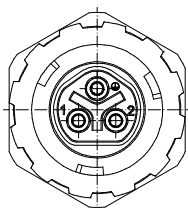
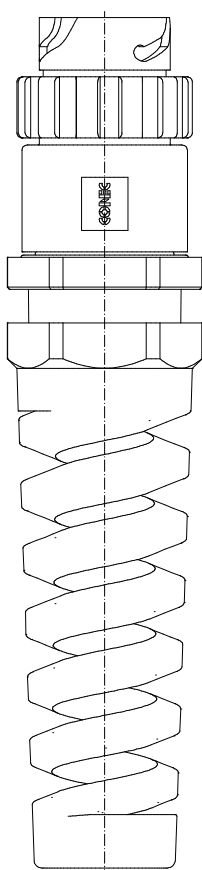
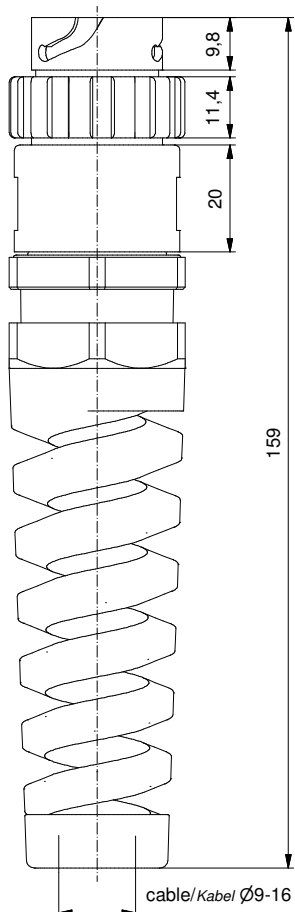
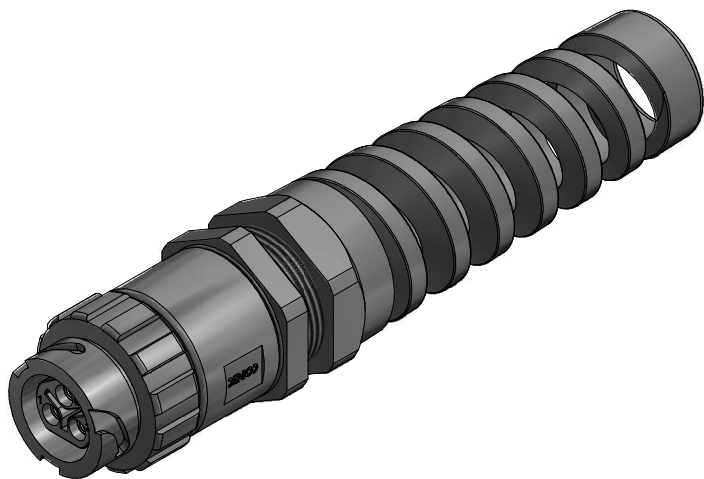

**Technical specification:**

**Technische Daten:**

Working voltage/ Betriebsspannung:	max. 250 V AC/DC
Degree of protection/ Schutzart:	IP67, rated when covered or fully mated with the appropriate mating connector/ IP67 bei Verwendung mit Kappe oder passenden Gegenstecker
Temperature range/ Temperaturbereich:	-40 °C ... +100 °C
Current rating/ Strombelastbarkeit:	High power contact crimp; 20 A/ Hochstromkontakt crimp; 20 A can be crimped with stranded copper wires: AWG 12-14/ crimpbar an Kupferlitze: AWG 12-14
UL-listed, File No./ UL- gelistet:	E318363

**Materials/**

**Werkstoffe:**

Coupler ring/ Kupplungsring:	PA GF (black/schwarz); UL 94 V-0; UL (f1) rated
Socket Housing/ Buchsengehäuse:	PA GF (black/schwarz); UL 94 V-0; UL (f1) rated
Cable gland/ Kabelanschluss:	PA (black/schwarz); UL 94 V-0; UL (f1) rated
Cable gland rubber ring/ Kabelanschluss Gummidichtung:	NBR, black/schwarz
Cable fitting/ Kabelverschraubung:	PA (black/schwarz); UL 94 V-0; UL (f1) rated
Interfacial seal/ Stirnflächendichtung:	Silicone, blue/ Silikon, blau
Retaining ring/ Haltering:	Stainless steel/ Edelstahl
High power contact/ Hochstromkontakt:	Cu alloy, Au over Ni

**Installation specification/**

**Montagedaten:**

Connector kit is recommended for use with following cable type/ Stecker wird für die Verwendung mit folgenden Kabeltypen empfohlen:	3 x Conductor AWG 12, Type SJOOW / 3 x Leiter AWG 12, Typ SJOOW 3 x Conductor AWG 14, Type SOOW / SJOOW 3 x Leiter AWG 14, Typ SOOW/SJOOW
Crimp-Tool/ Crimp-Werkzeug:	360X21079X
Tool insert/ Werkzeugeinsatz:	36-000430
Selector settings/ Selektor Einstellungen:	8 for AWG 12 7 for AWG 14
Turret Position/ Kopfposition:	12
Assembly instruction/ Montageanleitung:	AI-5055-Power

3 Contacts will be supplied loose/  
3 Kontakte werden lose geliefert

Stripping Dimensions/  
Kabelvorbereitung:

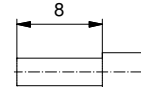
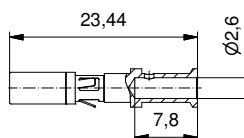

Part no. / Part marked Art.-Nr./ Bedruckung:	17-400323	Contact plating/ Kontakt Veredelung:	Power Contact 20 A/ Hochstromkontakt 20 A:	Plating, mating area: Veredelung Steckbereich: Plating, termination side: Veredelung Anschluss Seite: Plating, protection sleeve: Veredelung Schutzhülse:	Gold flash over Nickel Gold über Nickel Tin over Nickel Zinn über Nickel Nickel plated vernickel
-------------------------------------------------	-----------	-----------------------------------------	-----------------------------------------------	--------------------------------------------------------------------------------------------------------------------------------------------------------------------------	-----------------------------------------------------------------------------------------------------------------

Index: d Ä6469 13.02.17 K.H.	Scale/ Maßstab: 1:1	dwg no / Z.-nr.: 17K1A446	DIN-A3 1 / 1
Status: InBearbeitung			
RoHS compliant/konform			

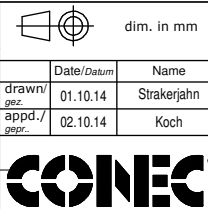

The reproduction, distribution and utilization of this document as well as the communication of its contents to other persons without express authorization is prohibited. Offenders will be held liable for the payment of damages. We hereby reserve the right to withdraw or change our offers.   
 Die Vervielfältigung, Verbreitung, auch auszugsweise, sowie das Weitergeben und Kopieren dieses Dokuments ist ohne schriftliche Genehmigung der CONEC AG.   
 Wir behalten uns das Recht vor, unsere Angebote jederzeit ohne Ankündigung zu ändern oder zurückzuziehen.