



Chipsmall Limited consists of a professional team with an average of over 10 year of expertise in the distribution of electronic components. Based in Hongkong, we have already established firm and mutual-benefit business relationships with customers from,Europe,America and south Asia,supplying obsolete and hard-to-find components to meet their specific needs.

With the principle of “Quality Parts,Customers Priority,Honest Operation,and Considerate Service”,our business mainly focus on the distribution of electronic components. Line cards we deal with include Microchip,ALPS,ROHM,Xilinx,Pulse,ON,Everlight and Freescale. Main products comprise IC,Modules,Potentiometer,IC Socket,Relay,Connector.Our parts cover such applications as commercial,industrial, and automotives areas.

We are looking forward to setting up business relationship with you and hope to provide you with the best service and solution. Let us make a better world for our industry!



Contact us

Tel: +86-755-8981 8866 Fax: +86-755-8427 6832

Email & Skype: info@chipsmall.com Web: www.chipsmall.com

Address: A1208, Overseas Decoration Building, #122 Zhenhua RD., Futian, Shenzhen, China



Alle Rechte vorbehalten/ All rights reserved

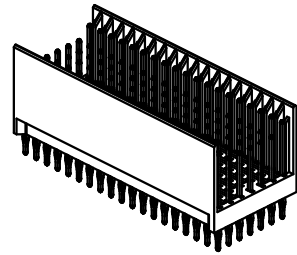
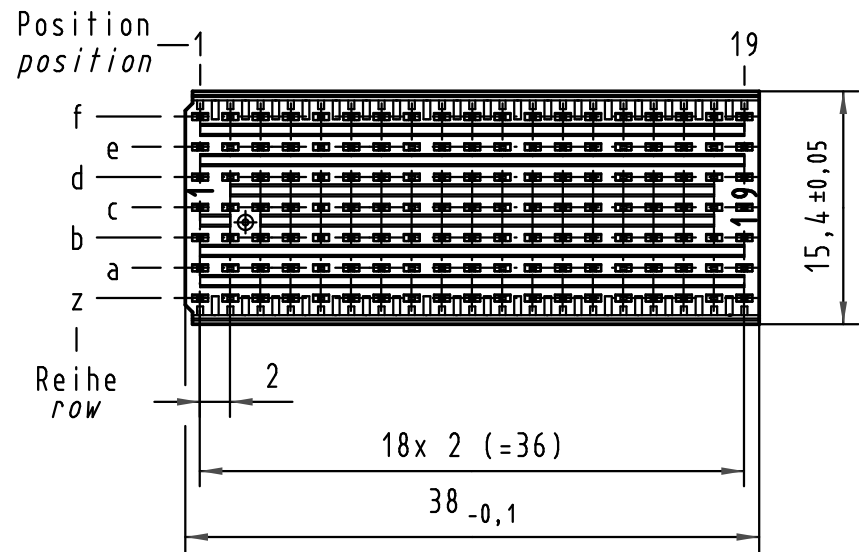
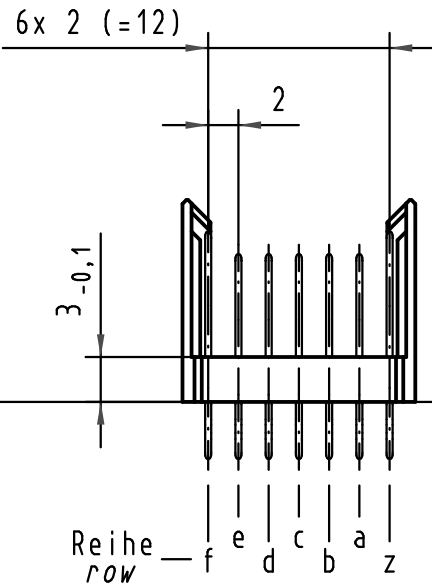
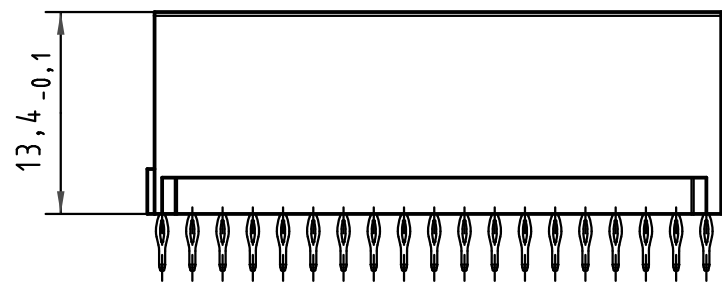

**Lochbild
board drillings**

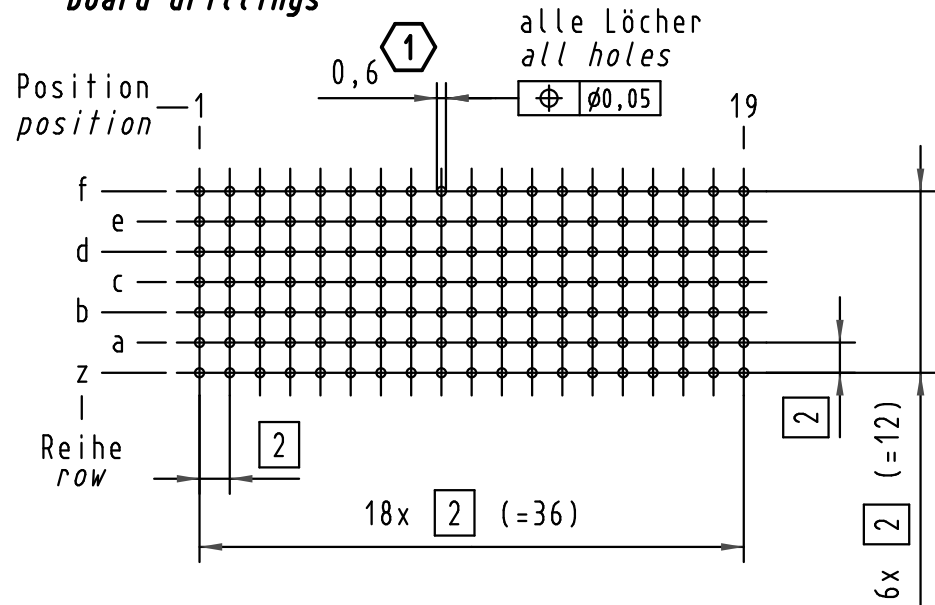

**Kontakt-Maße
contact dimensions**

(Längen der Steck- und Anschlußseite gelten für eingepreßte Steckverbinder)
(mating and termination length of contacts apply to pressed in connectors)

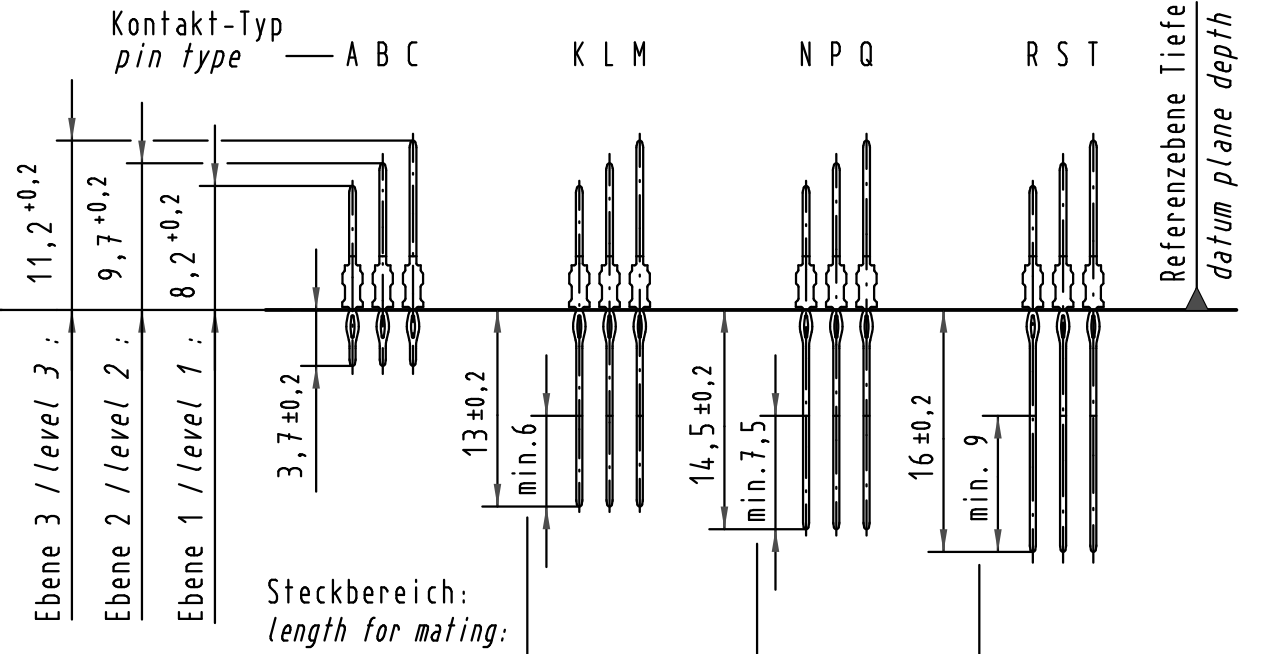

**Kontaktbelegung
contact loading**

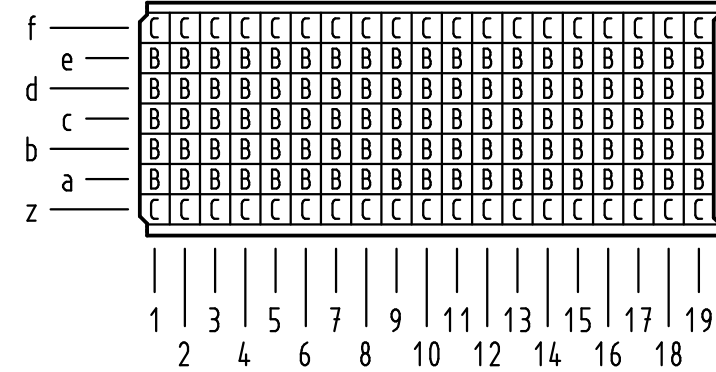

1 **Empfohlener Lochaufbau und weitere Informationen siehe: DS 17 00 110 0101**
recommended configuration of plated through holes and further information see: DS 17 00 110 0101

17 05 133 4203	S4
17 05 133 2203	2
17 05 133 1203	1
Bestell-Nr. part-no.	Anforderungsstufe performance level 1

All Dimensions in mm Original Size DIN A 3			Techn. Character.		
Mod.	Dat.	Name	Dat.	Name	Maßstab/Scale
35967	08.01.10	Hage.	Detail.	27.08.98	HL.
35560	21.08.09	Hage.	Insp.	27.08.98	Weil.
34337	22.05.07	Clä	Stand.		
29392	08.03.01	Rie.			
24109					
HARTING Electronics GmbH & Co. KG D-32339 ESPELKAMP					

Nicht tolerierte Maßel/Free size tolerances IEC 61076-4-101	
har-bus HM Messerleiste Typ B-19 133pol., Anschlußlänge 3,7mm har-bus HM male connector type B-19 133pol., termination length 3,7mm	
TB 17 05 133 x203	Blatt/page
Sub.	