



Chipsmall Limited consists of a professional team with an average of over 10 year of expertise in the distribution of electronic components. Based in Hongkong, we have already established firm and mutual-benefit business relationships with customers from,Europe,America and south Asia,supplying obsolete and hard-to-find components to meet their specific needs.

With the principle of “Quality Parts,Customers Priority,Honest Operation,and Considerate Service”,our business mainly focus on the distribution of electronic components. Line cards we deal with include Microchip,ALPS,ROHM,Xilinx,Pulse,ON,Everlight and Freescale. Main products comprise IC,Modules,Potentiometer,IC Socket,Relay,Connector.Our parts cover such applications as commercial,industrial, and automotives areas.

We are looking forward to setting up business relationship with you and hope to provide you with the best service and solution. Let us make a better world for our industry!



## Contact us

Tel: +86-755-8981 8866 Fax: +86-755-8427 6832

Email & Skype: info@chipsmall.com Web: www.chipsmall.com

Address: A1208, Overseas Decoration Building, #122 Zhenhua RD., Futian, Shenzhen, China



Alle Rechte vorbehalten/ All rights reserved

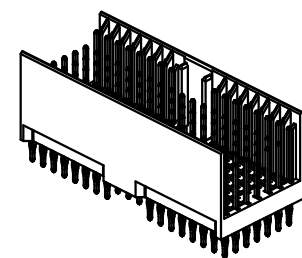
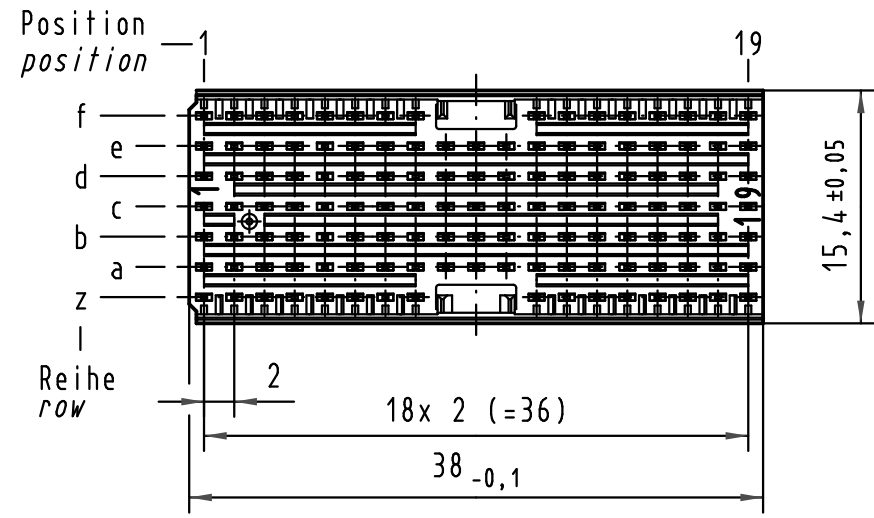
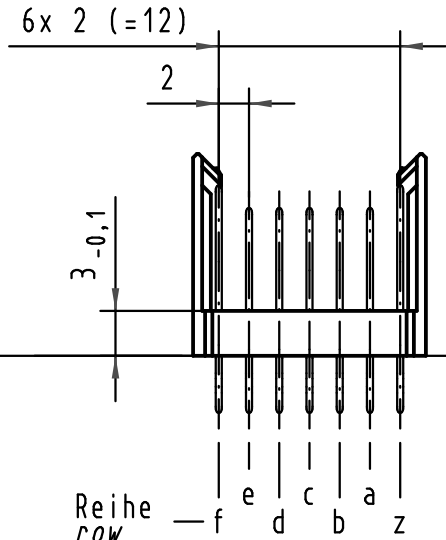
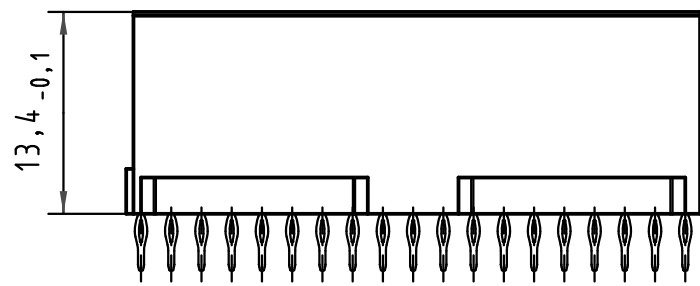

**Lochbild  
board drillings**

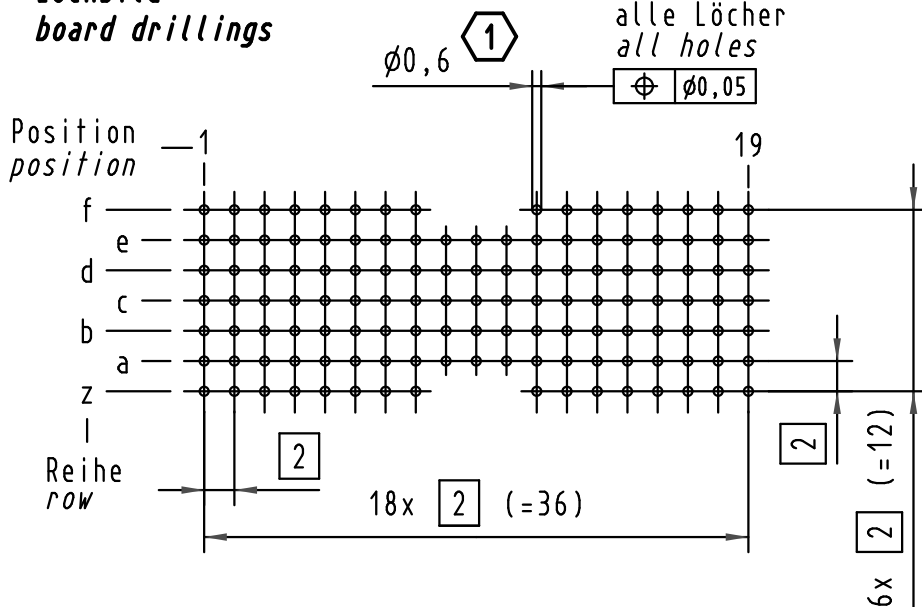

**Kontakt-Maße  
contact dimensions**

(Längen der Steck- und Anschlußseite gelten für eingepreßte Steckverbinder)  
(mating and termination length of contacts apply to pressed in connectors)

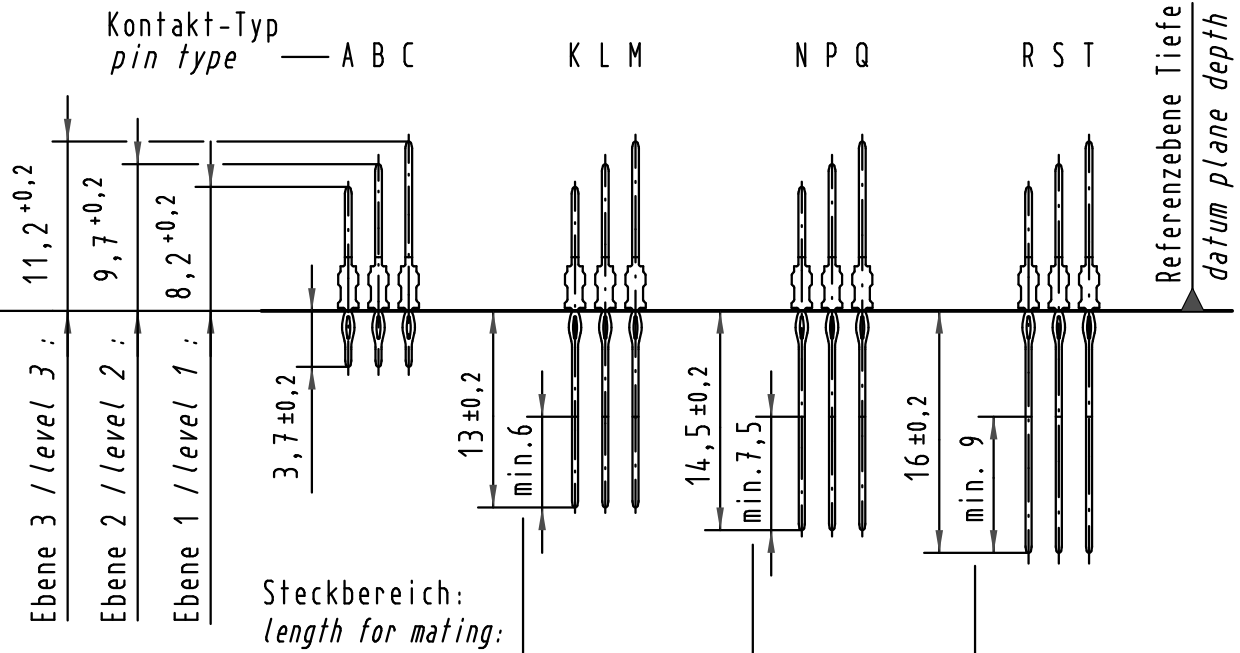

**Kontaktbelegung  
contact loading**

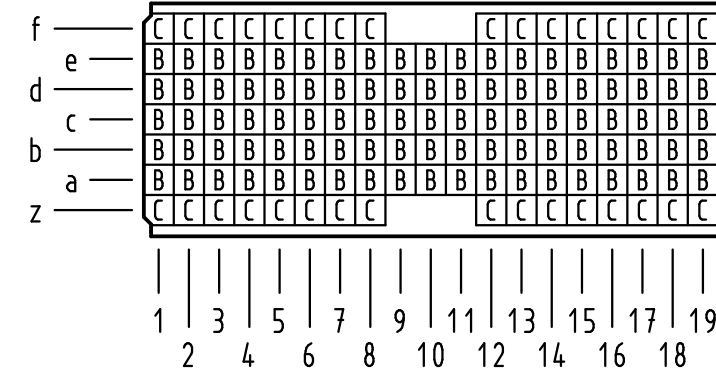

1 Empfohlener Lochaufbau und weitere Informationen siehe: DS 17 00 110 0101  
recommended configuration of plated through holes and further information see: DS 17 00 110 0101

17 13 127 4202	S4
17 13 127 2202	2
17 13 127 1202	1
Bestell-Nr. part-no.	Anforderungsstufe performance level 1

	Techn. Character.			Nicht tolerierte Maße/Free size tolerances IEC 61076-4-101	
	Dat.	Name	Maßstab/Scale	har-bus HM Messerleiste Typ AB-19 127pol., Anschlußlänge 3,7mm har-bus HM male connector type AB-19 127pol., termination length 3,7mm	
35994	05.02.10	Hage.	2:1	TB 17 13 127 x202	
34337	31.05.07	Cla		Blatt/page	
29812				Sub.	
Mod.	Dat.	Name	HARTING Electronics GmbH & Co. KG D-32339 ESPELKAMP		