



Chipsmall Limited consists of a professional team with an average of over 10 year of expertise in the distribution of electronic components. Based in Hongkong, we have already established firm and mutual-benefit business relationships with customers from,Europe,America and south Asia,supplying obsolete and hard-to-find components to meet their specific needs.

With the principle of "Quality Parts,Customers Priority,Honest Operation,and Considerate Service",our business mainly focus on the distribution of electronic components. Line cards we deal with include Microchip,ALPS,ROHM,Xilinx,Pulse,ON,Everlight and Freescale. Main products comprise IC,Modules,Potentiometer,IC Socket,Relay,Connector.Our parts cover such applications as commercial,industrial, and automotives areas.

We are looking forward to setting up business relationship with you and hope to provide you with the best service and solution. Let us make a better world for our industry!



## Contact us

Tel: +86-755-8981 8866 Fax: +86-755-8427 6832

Email & Skype: info@chipsmall.com Web: www.chipsmall.com

Address: A1208, Overseas Decoration Building, #122 Zhenhua RD., Futian, Shenzhen, China



CKT NO	PART NO	DIM A
2	171692-0102	8.35
4	171692-0104	12.05
6	171692-0106	17.75
8	171692-0108	23.45 +0.40
10	171692-0110	29.15 +0.40
12	171692-0112	34.85 +0.40

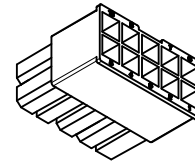
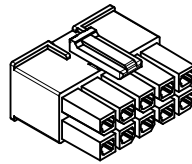
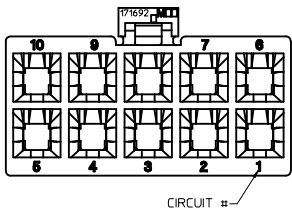
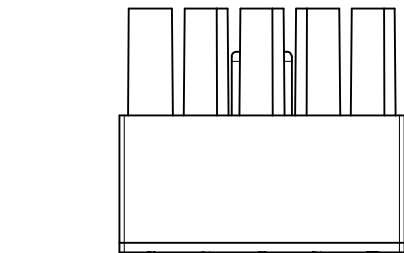
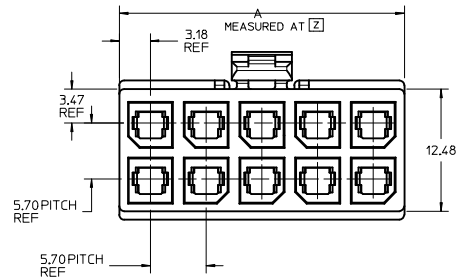
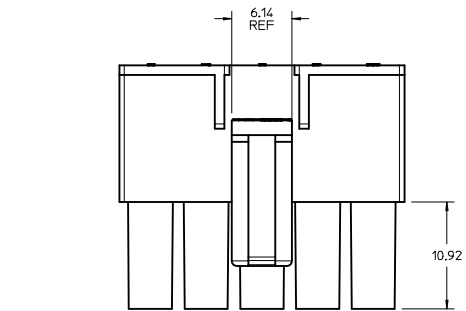

171692-0110

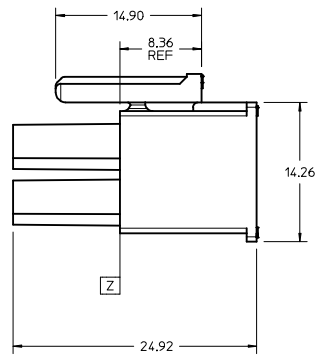

NOTES:

- MATERIAL:  
HOUSING: PBT, UL 94V-0, COLOR: BLACK.
- FINISH: NOT APPLICABLE.
- PRODUCT SPECIFICATION: PS-76823-100.
- PACKAGING: BULK PACK PER PK-170001-001
- PART MATES WITH MOLEX SERIES NUMBERS 76825, 76829, 172064, AND 172065.
- PART IS FOR USE WITH MOLEX FEMALE TERMINAL 76823 OR 172063 SERIES.
- APPLICATION SPECIFICATION: AS-76823-100.
- PARTS CONFORM TO CLASS B REQUIREMENTS OF COSMETIC SPECIFICATION PS-45499-002 WITH THE EXCEPTION OF DISCOLORATION MEETS CLASS "C" REQUIREMENTS.

REVISE RIBS IEC NO: UCP2015-2016 2015/01/09 DRAWN: BELL 2015/01/09 CHKD: BELL 2015/03/10 APPR: SMITH	QUALITY SYMBOLS ∇=0 ∇=0 ∇=0	GENERAL TOLERANCES (UNLESS SPECIFIED): mm INCH		DIMENSION STYLE MM ONLY		SCALE 4:1	DESIGN UNITS METRIC	THIRD ANGLE PROJECTION
		4 PLACES ±--- ±--- 3 PLACES ±--- ±--- 2 PLACES ±0.25 ±--- 1 PLACE ±--- ±--- 0 PLACE ±--- ±---	ANGULAR ±1/2° DRAFT WHERE APPLICABLE MUST REMAIN WITHIN DIMENSIONS	DRAWN BY MKARADIMAS DATE 2012/08/01	CHECKED BY A. PATEL DATE 2012/08/17	TITLE MEGA-FIT RECEPTACLE HOUSING 2-12 CKT		MATERIAL NO. SD-171692-0100

20 19 18 17 16 15 14 13 12 11 10 9 8 7 6 5 4 3 2 1

2 CKTS

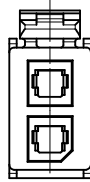

4 CKT

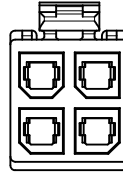

6 CKT

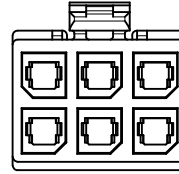

8 CKT

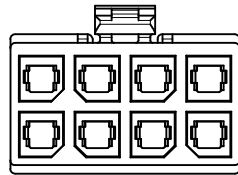

10 CKTS

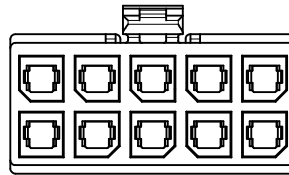

12 CKTS

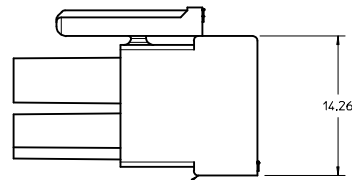
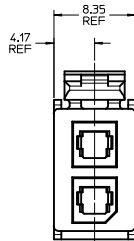
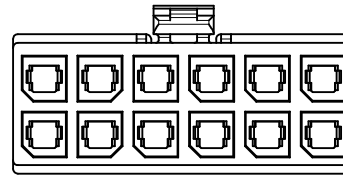

BOTTOM RIB ON  
2 CKT ONLY

171692-0102

SEE SHT 1 IEC NO: UCP2015-2016 DRAWN: J.BELL 2015/01/09 CHECKED: J.BELL 2015/01/09 APPROVED: F.S.MITH 2015/03/10	QUALITY SYMBOLS ∇=0 ∇=0 ∇=0	GENERAL TOLERANCES (UNLESS SPECIFIED)		DIMENSION STYLE <b>MM ONLY</b>	SCALE <b>4:1</b>	DESIGN UNITS <b>METRIC</b>	THIRD ANGLE PROJECTION		
		4 PLACES ±--- ±--- 3 PLACES ±--- ±--- 2 PLACES ±0.25 ±--- 1 PLACE ±--- ±--- 0 PLACE ±--- ±---	mm INCH	DRAWN BY MKARADIMAS	DATE 2012/08/01	TITLE <b>MEGA-FIT RECEPTACLE HOUSING 2-12 CKT</b>			
		ANGULAR ±1/2° DRAFT WHERE APPLICABLE MUST REMAIN WITHIN DIMENSIONS		APPROVED BY APATEL	DATE 2012/08/17	MATERIAL NO. <b>SEE CHART</b>	DOCUMENT NO. <b>SD-171692-0100</b>	SHEET NO. 2 OF 2	

THIS DRAWING CONTAINS INFORMATION THAT IS PROPRIETARY TO MOLEX INCORPORATED AND SHOULD NOT BE USED WITHOUT WRITTEN PERMISSION

19 18 17 16 15 14 13 12 11 10 9 8 7 6 5 4 3 2 1